

# Photometer System MD 600 / MaxiDirect





## Important steps before using the photometer

Please carry out the following steps as described in the Instruction manual. Become familiar with your new photometer before starting with the first tests:

- Unpacking and inspection of delivery contents, see page 352.
- Install the batteries, see page 300 and the following.

Perform the following settings in the Mode-Menu; Instruction manual from page 311 and following:

- MODE 10: select language
- MODE 12: set date and time
- **MODE 34: perform "Delete data"**
- **MODE 69: perform "User m. init" to initialise the user polynomial system**

If required set other functions.





DE

### Wichtige Information

#### Um die Qualität unserer Umwelt zu erhalten, beschützen und zu verbessern Entsorgung von elektronischen Geräten in der Europäischen Union

Aufgrund der Europäischen Verordnung 2012/19/EU darf Ihr elektronisches Gerät nicht mit dem normalen Hausmüll entsorgt werden!

Tintometer GmbH entsorgt ihr elektrisches Gerät auf eine professionelle und für die Umwelt verantwortungsvolle Weise. Dieser Service ist, **die Transportkosten nicht inbegriffen**, kostenlos. Dieser Service gilt ausschließlich für elektrische Geräte die nach dem 13.08.2005 erworben wurden. Senden Sie Ihre zu entsorgenden Tintometer Geräte frei Haus an Ihren Lieferanten.

GB

### Important Information

#### To Preserve, Protect and Improve the Quality of the Environment Disposal of Electrical Equipment in the European Union

Because of the European Directive 2012/19/EU your electrical instrument must not be disposed of with normal household waste!

Tintometer GmbH will dispose of your electrical instrument in a professional and environmentally responsible manner. This service, **excluding the cost of transportation** is free of charge. This service only applies to electrical instruments purchased after 13th August 2005. Send your electrical Tintometer instruments for disposal freight prepaid to your supplier.

FR

### Notice importante

#### Conserver, protéger et optimiser la qualité de l'environnement Élimination du matériel électrique dans l'Union Européenne

Conformément à la directive européenne n° 2012/19/UE, vous ne devez plus jeter vos instruments électriques dans les ordures ménagères ordinaires !

La société Tintometer GmbH se charge d'éliminer vos instruments électriques de façon professionnelle et dans le respect de l'environnement. Ce service, **qui ne comprend pas les frais de transport**, est gratuit. Ce service n'est valable que pour des instruments électriques achetés après le 13 août 2005. Nous vous prions d'envoyer vos instruments électriques Tintometer usés à vos frais à votre fournisseur.

NL

### Belangrijke informatie

#### Om de kwaliteit van ons leefmilieu te behouden, te verbeteren en te beschermen is voor landen binnen de Europese Unie de Europese richtlijn 2012/19/EU voor het verwijderen van elektronische apparatuur opgesteld.

Volgens deze richtlijn mag elektronische apparatuur niet met het huishoudelijk afval worden afgevoerd.

Tintometer GmbH verwijdert uw elektronisch apparaat op een professionele en milieubewuste wijze. Deze service is, **exclusief de verzendkosten**, gratis en alleen geldig voor elektrische apparatuur die na 13 augustus 2005 is gekocht. Stuur uw te verwijderen Tintometer apparatuur franco aan uw leverancier.



ES

### Información Importante

#### Para preservar, proteger y mejorar la calidad del medio ambiente Eliminación de equipos eléctricos en la Unión Europea

Con motivo de la Directiva Europea 2012/19/UE, ¡ningún instrumento eléctrico deberá eliminarse junto con los residuos domésticos diarios!

Tintometer GmbH se encargará de dichos instrumentos eléctricos de una manera profesional y sin dañar el medio ambiente. Este servicio, **el cual excluye los gastos de transporte**, es gratis y se aplicará únicamente a aquellos instrumentos eléctricos adquiridos después del 13 de agosto de 2005. Se ruega enviar aquellos instrumentos eléctricos inservibles de Tintometer a carga pagada a su distribuidor.

IT

### Informazioni importanti

#### Conservare, proteggere e migliorare la qualità dell'ambiente Smaltimento di apparecchiature elettriche nell'Unione Europea

In base alla Direttiva europea 2012/19/UE, gli apparecchi elettrici non devono essere smaltiti insieme ai normali rifiuti domestici!

Tintometer GmbH provvederà a smaltire i vostri apparecchi elettrici in maniera professionale e responsabile verso l'ambiente. Questo servizio, **escluso il trasporto**, è completamente gratuito. Il servizio si applica agli apparecchi elettrici acquistati successivamente al 13 agosto 2005. Siete pregati di inviare gli apparecchi elettrici Tintometer divenuti inutilizzabili a trasporto pagato al vostro rivenditore.

PT

### Informação Importante

#### Para Preservar, Proteger e Melhorar a Qualidade do Ambiente Remoção de Equipamento Eléctrico na União Europeia

Devido à Directiva Europeia 2012/19/UE, o seu equipamento eléctrico não deve ser removido com o lixo doméstico habitual!

A Tintometer GmbH tratará da remoção do seu equipamento eléctrico de forma profissional e responsável em termos ambientais. Este serviço, **não incluindo os custos de transporte**, é gratuito. Este serviço só é aplicável no caso de equipamentos eléctricos comprados depois de 13 de Agosto de 2005. Por favor, envie os seus equipamentos eléctricos Tintometer que devem ser removidos ao seu fornecedor (transporte pago).

PL

### Istotna informacja

#### Dla zachowania, ochrony oraz poprawy naszego środowiska Usuwanie urządzeń elektronicznych w Unii Europejskiej

Na podstawie Dyrektywy Parlamentu Europejskiego 2012/19/UE nie jest dozwolone usuwanie zakupionych przez Państwo urządzeń elektronicznych wraz z normalnymi odpadami z gospodarstwa domowego!

Tintometer GmbH usunie urządzenia elektrycznego Państwa w sposób profesjonalny i odpowiedzialny z punktu widzenia środowiska. Serwis ten jest, za wyjątkiem kosztów transportu, bezpłatny. Serwis ten odnosi się wyłącznie do urządzeń elektrycznych zakupionych po 13.08.2005r. Przeznaczony do usunięcia urządzenia firmy Tintometer mogą Państwo przesyłać na koszt własny do swojego dostawcy.

**DE**

### **Wichtiger Entsorgungshinweis zu Batterien und Akkus**

Jeder Verbraucher ist aufgrund der Batterieverordnung (Richtlinie 2006/66/EG) gesetzlich zur Rückgabe aller ge- und verbrauchten Batterien bzw. Akkus verpflichtet. Die Entsorgung über den Hausmüll ist verboten. Da auch bei Produkten aus unserem Sortiment Batterien und Akkus im Lieferumfang enthalten sind, weisen wir Sie auf folgendes hin:

Verbrauchte Batterien und Akkus gehören nicht in den Hausmüll, sondern können unentgeltlich bei den öffentlichen Sammelstellen Ihrer Gemeinde und überall dort abgegeben werden, wo Batterien und Akkus der betreffenden Art verkauft werden. Weiterhin besteht für den Endverbraucher die Möglichkeit, Batterien und Akkus an den Händler, bei dem sie erworben wurden, zurückzugeben (gesetzliche Rücknahmepflicht).

**GB**

### **Important disposal instructions for batteries and accumulators**

EC Guideline 2006/66/EC requires users to return all used and worn-out batteries and accumulators. They must not be disposed of in normal domestic waste. Because our products include batteries and accumulators in the delivery package our advice is as follows :

Used batteries and accumulators are not items of domestic waste. They must be disposed of in a proper manner. Your local authority may have a disposal facility; alternatively you can hand them in at any shop selling batteries and accumulators. You can also return them to the company which supplied them to you; the company is obliged to accept them.

**FR**

### **Information importante pour l'élimination des piles et des accumulateurs**

En vertu de la Directive européenne 2006/66/CE relative aux piles et accumulateurs, chaque utilisateur est tenu de restituer toutes les piles et tous les accumulateurs utilisés et épuisés. L'élimination avec les déchets ménagers est interdite. Etant donné que l'étendue de livraison des produits de notre gamme contient également des piles et des accumulateurs, nous vous signalons ce qui suit :

les piles et les accumulateurs utilisés ne sont pas des ordures ménagères, ils peuvent être remis sans frais aux points de collecte publics de votre municipalité et partout où sont vendus des piles et accumulateurs du type concerné. Par ailleurs, l'utilisateur final a la possibilité de remettre les piles et les accumulateurs au commerçant auprès duquel ils ont été achetés (obligation de reprise légale).

**NL**

### **Belangrijke mededeling omtrent afvoer van batterijen en accu's**

Ledere verbruiker is op basis van de richtlijn 2006/66/EG verplicht om alle gebruikte batterijen en accu's in te leveren. Het is verboden deze af te voeren via het huisvuil. Aangezien ook onze producten geleverd worden met batterijen en accu's wijzen wij u op het volgende; Lege batterijen en accu's horen niet in het huisvuil thuis. Men kan deze inleveren bij inzamelpunten van uw gemeente of overal daar waar deze verkocht worden. Tevens bestaat de mogelijkheid batterijen en accu's daar in te leveren waar u ze gekocht heeft. (wettelijke terugnameplicht)



**ES****Indicación importante acerca de la eliminación de pilas y acumuladores**

Basado en la norma relativa a pilas/ baterías (directiva 2006/66/CE), cada consumidor, está obligado por ley, a la devolución de todas las pilas/ baterías y acumuladores usados y consumidos. Está prohibida la eliminación en la basura doméstica. Ya que en productos de nuestra gama, también se incluyen en el suministro pilas y acumuladores, le sugerimos lo siguiente:

Las pilas y acumuladores usados no pertenecen a la basura doméstica, sino que pueden ser entregados en forma gratuita en cada uno de los puntos de recolección públicos de su comunidad en los cuales se vendan pilas y acumuladores del tipo respectivo. Además, para el consumidor final existe la posibilidad de devolver las pilas y baterías recargables a los distribuidores donde se hayan adquirido (obligación legal de devolución).

**IT****Indicazioni importanti sullo smaltimento di pile e accumulatori**

In base alla normativa concernente le batterie (Direttiva 2006/66/CE) ogni consumatore è tenuto per legge alla restituzione di tutte le batterie o accumulatori usati ed esauriti. È vietato lo smaltimento con i rifiuti domestici. Dato che anche alcuni prodotti del nostro assortimento sono provvisti di pile e accumulatori, vi diamo di seguito delle indicazioni: Pile e accumulatori esauriti non vanno smaltiti insieme ai rifiuti domestici, ma depositati gratuitamente nei punti di raccolta del proprio comune o nei punti vendita di pile e accumulatori dello stesso tipo. Inoltre il consumatore finale può portare batterie e accumulatori al rivenditore presso il quale li ha acquistati (obbligo di raccolta previsto per legge).

**PT****Instruções importantes para a eliminação residual de pilhas e acumuladores**

Os utilizadores finais são legalmente responsáveis, nos termos do Regulamento relativo a pilhas e acumuladores (Directiva 2006/66/CE), pela entrega de todas as pilhas e acumuladores usados e gastos. É proibida a sua eliminação juntamente com o lixo doméstico. Uma vez que determinados produtos da nossa gama contêm pilhas e/ou acumuladores, alertamos para os seguintes aspectos:

As pilhas e acumuladores usados não podem ser eliminados com o lixo doméstico, devendo sim ser entregues, sem encargos, junto dos pontos de recolha públicos do seu município, ou em qualquer ponto de venda de pilhas e acumuladores. O utilizador final dispõe ainda da possibilidade de entregar as pilhas e/ou acumuladores no estabelecimento comerciante onde os adquiriu (dever legal de aceitar a devolução).

**PL****Istotna wskazówka dotycząca utylizacji baterii i akumulatorów**

Każdy użytkownik na mocy rozporządzenia w sprawie baterii (wytyczna 2006/66/WE) jest ustawowo zobowiązany do oddawania wszystkich rozładowanych i zużytych baterii lub akumulatorów. Utylizacja wraz z odpadkami domowymi jest zabroniona. Ponieważ także w produktach z naszego asortymentu zawarte są w zakresie dostawy baterie i akumulatory, zwracamy uwagę na poniższe zasady: zużyte baterie i akumulatory nie mogą być wyrzucane wraz z odpadkami domowymi, lecz powinny być bezpłatnie przekazywane w publicznych miejscach zbiórki wyznaczonych przez gminę lub oddawane w punktach, gdzie sprzedawane są baterie i akumulatory danego rodzaju. Poza tym użytkownik końcowy ma możliwość zwrócenia baterii i akumulatorów do przedstawiciela handlowego, u którego je nabył (ustawowy obowiązek przyjęcia).





## Safety precautions



Reagents are formulated exclusively for chemical analysis and must not be used for any other purpose. Reagents must not get into the hands of children. Some of the reagents contain substances which are not entirely harmless environmentally. Be aware of the ingredients and take proper care when disposing of the test solution.



Please read this instruction manual before unpacking, setting up or using the photometer. Please read the method description completely before performing the test. Be aware of the risks of using the required reagents by reading the MSDS (Material Safety Data Sheets). Failure could result in serious injury to the operator or damage to the instrument.

MSDS: [www.lovibond.com](http://www.lovibond.com)



The accuracy of the instrument is only valid if the instrument is used in an environment with controlled electromagnetic disturbances according to DIN 61326. Wireless devices, e.g. wireless phones, must not be used near the instrument.

# Table of contents

<b>Part 1 Methods</b> .....	7
<b>1.1 Table of Methods</b> .....	8
Acid demand to pH 4.3.....	14
Alkalinity-total (Alkalinity-m, m-Value).....	16
Alkalinity-total HR (Alkalinity-m HR, m-Value HR) .....	18
Alkalinity-p (p-Value).....	20
Aluminium with tablets.....	22
Aluminium (powder pack).....	24
Ammonia with tablet .....	26
Ammonia (powder pack).....	28
Ammonia, low range (LR).....	30
Ammonia, high range (HR).....	32
Boron .....	34
Bromine with tablet .....	36
Bromine (powder pack).....	38
Chloride with tablet.....	40
Chloride with Liquid Reagent .....	42
Chlorine.....	44
Chlorine with tablet.....	46
free Chlorine.....	46
total Chlorine.....	47
differentiated determination (free, combined, total) .....	48
Chlorine HR with tablet.....	50
free Chlorine.....	50
total Chlorine.....	51
differentiated determination (free, combined, total) .....	52
Chlorine with liquid reagent.....	54
free Chlorine.....	54
total Chlorine.....	55
differentiated determination (free, combined, total) .....	56
Chlorine (powder pack).....	58
free Chlorine.....	58
total Chlorine.....	59
differentiated determination (free, combined, total) .....	60
Chlorine MR (VARIO powder pack).....	62
free Chlorine.....	62
total Chlorine.....	63
differentiated determination (free, combined, total) .....	64
Chlorine HR (powder pack) .....	66
free Chlorine.....	66
total Chlorine.....	67
differentiated determination (free, combined, total) .....	68
Chlorine dioxide with tablet.....	70

in presence of Chlorine .....	72
in absence of Chlorine .....	75
Chlorine dioxide (powder pack).....	76
in absence of Chlorine .....	76
in presence of Chlorine .....	77
Chlorine HR (KI) .....	80
Chlorite in presence of Chlorine and Chlorine dioxide .....	82
Chromium with Powder Pack.....	86
differentiated determination.....	88
Chromium (VI) .....	90
Chromium, total (Cr(III) + Cr(VI)).....	91
COD, low range (LR) .....	92
COD, middle range (MR).....	94
COD, high range (HR) .....	96
Colour, true and apparent.....	98
Copper with tablet.....	100
differentiated determination (free, combined, total) .....	101
free Copper .....	102
total Copper .....	103
Copper with liquid reagent and powder.....	104
differentiated determination (free, combined, total) .....	105
free Copper .....	107
total Copper .....	108
Copper (powder pack) .....	110
Cyanide .....	112
CyA-TEST (Cyanuric acid) .....	114
DEHA T.....	116
DEHA PP .....	118
Fluoride .....	120
H <sub>2</sub> O <sub>2</sub> with tablet reagent.....	122
H <sub>2</sub> O <sub>2</sub> LR with liquid reagent.....	124
H <sub>2</sub> O <sub>2</sub> HR with liquid reagent.....	126
Hardness, Calcium with Calcheck tablet.....	128
Hardness, Calcium with Calcio tablet .....	130
Hardness, total.....	132
Hardness, total HR .....	134
Hydrazine .....	136
Hydrazine with liquid reagent .....	138
Hydrazine with Vacu-vials.....	140
Iodine .....	142
Iron.....	144
Iron with tablet .....	146
Iron (powder pack).....	148
Iron TPTZ (powder pack).....	150
Iron (Fe in Mo, powder pack) .....	152

Iron LR with liquid reagent .....	154
Iron LR 2 with liquid reagent .....	158
Iron HR with liquid reagent .....	162
Manganese with tablet .....	166
Manganese LR (powder pack) .....	168
Manganese HR (powder pack) .....	170
Manganese with liquid reagent.....	172
Molybdate with tablet.....	174
Molybdate LR (powder pack).....	176
Molybdate HR (powder pack).....	178
Molybdate HR with liquid reagent.....	180
Nickel with tablet.....	182
Nitrate with tablet and powder .....	184
Nitrate (tube test).....	186
Nitrite with tablet.....	188
Nitrite LR (powder pack).....	190
Nitrogen, total LR.....	192
Nitrogen, total HR.....	194
Oxygen, active .....	198
Oxygen, dissolved .....	200
Ozone.....	202
in presence of Chlorine .....	204
in absence of Chlorine .....	206
PHMB (Biguanide).....	208
Phosphate.....	210
Phosphate, ortho LR with tablet .....	212
Phosphate, ortho HR with tablet .....	214
Phosphate, ortho (powder pack) .....	216
Phosphate, ortho (tube test).....	218
Phosphate 1, ortho C .....	220
Phosphate 2, ortho C .....	222
Phosphate, hydrolyzable (tube test).....	224
Phosphate, total (tube test) .....	226
Phosphate LR with Liquid reagent .....	228
Phosphate HR with Liquid reagent.....	232
Phosphonates .....	236
pH value LR with tablet .....	240
pH value with tablet.....	242
pH value with liquid reagent .....	244
pH value HR with tablet .....	246
Polyacrylate with liquid reagent.....	248
Potassium .....	252
Silica .....	254
Silica LR PP.....	256
Silica HR PP.....	258

Silica with liquid reagent and powder .....	260
Sodium hypochlorite .....	262
Sulfate with tablet .....	264
Sulfate (powder pack) .....	266
Sulfide .....	268
Sulfite .....	270
Surfactants, anionic .....	272
Surfactants, nonionic .....	274
Surfactants, cationic .....	276
Suspended Solids .....	278
TOC LR .....	280
TOC HR .....	282
Tolyltriazole / Triazole / Benzotriazole (powder pack) .....	284
Turbidity .....	286
Urea .....	288
Zinc with tablet .....	290
Zinc with liquid reagent and powder .....	292
<b>1.2 Important notes .....</b>	<b>294</b>
1.2.1 Correct use of reagents .....	294
1.2.2 Cleaning of vials and accessories for analysis .....	295
1.2.3 Guidelines for photometric measurements .....	295
1.2.4 Sample dilution techniques .....	297
1.2.5 Correcting for volume additions .....	297
<b>Part 2 Instrument Manual .....</b>	<b>299</b>
<b>2.1 Operation .....</b>	<b>300</b>
2.1.1 Set up .....	300
2.1.2 Saving data – Important Notes .....	300
2.1.3 Replacement of batteries .....	300
2.1.4 Instrument (explosion drawing) .....	301
<b>2.2 Overview of function keys .....</b>	<b>303</b>
2.2.1 Overview .....	303
2.2.2 Displaying time and date .....	304
2.2.3 User countdown .....	304
<b>2.3 Operation mode .....</b>	<b>305</b>
2.3.1 Automatic switch off .....	305
2.3.2 Selecting a method .....	305
2.3.2.1 Method Information (F1) .....	305
2.3.2.2 Chemical Species Information .....	306
2.3.3 Differentiation .....	306
2.3.4 Performing Zero .....	306
2.3.5 Performing Tests .....	307
2.3.6 Ensuring reaction periods (countdown) .....	307
2.3.7 Changing chemical species .....	308

2.3.8	Storing results .....	308
2.3.9	Printing results (Infra-Red Interface Module) (optional).....	309
2.3.10	Perform additional measurements .....	309
2.3.11	Selecting a new method.....	310
2.3.12	Measure absorbance .....	310
<b>2.4</b>	<b>Photometer settings: Table of Mode Functions .....</b>	<b>311</b>
2.4.1	blank because of technical requirements .....	312
2.4.2	Instrument basic settings 1 .....	312
2.4.3	Printing of stored results.....	316
2.4.4	Recall / delete stored results.....	321
2.4.5	Calibration .....	326
2.4.6	Lab function.....	334
	Profi-Mode.....	334
	One Time Zero .....	335
2.4.7	User operations .....	336
	User method list.....	336
	User Concentration Methods.....	338
	User Polynomials .....	340
	Delete User Methods.....	343
	Print Data of User Methods .....	344
	Initialise User Method System .....	345
2.4.8	Special functions .....	346
	Langelier Saturation Index .....	346
2.4.9	Instrument basic settings 2 .....	348
2.4.10	Instrument special functions /service.....	349
<b>2.5</b>	<b>Data transfer.....</b>	<b>350</b>
2.5.1	Data Printing .....	350
2.5.2	Data transfer to a personal computer .....	350
2.5.3	Internet Updates .....	350
<b>Part 3</b>	<b>Enclosure.....</b>	<b>351</b>
<b>3.1</b>	<b>Unpacking .....</b>	<b>352</b>
<b>3.2</b>	<b>Delivery contents .....</b>	<b>352</b>
<b>3.3</b>	<b>blank because of technical requirements .....</b>	<b>352</b>
<b>3.4</b>	<b>Technical data .....</b>	<b>353</b>
<b>3.5</b>	<b>Abbreviations .....</b>	<b>354</b>
<b>3.6</b>	<b>Troubleshooting .....</b>	<b>355</b>
3.6.1	Operating messages in the display / error display .....	355
3.6.2	General .....	357
<b>3.7</b>	<b>Declaration of CE-Conformity .....</b>	<b>358</b>

# **Part 1**

# **Methods**

## 1.1 Table of Methods

No.	Analysis	Reagent	Range	Displayed as	Method	$\lambda$ [nm]	OTZ	Page
20	<b>Acid demand to pH 4.3 T</b>	tablet	0.1-4	mmol/l	Acid/Indicator <sup>1,2,5</sup>	610	✓	14
30	<b>Alkalinity, total T</b>	tablet	5-200	mg/l CaCO <sub>3</sub>	Acid/Indicator <sup>1,2,5</sup>	610	✓	16
31	<b>Alkalinity HR, total T</b>	tablet	5-500	mg/l CaCO <sub>3</sub>	Acid/Indicator <sup>1,2,5</sup>	610	✓	18
35	<b>Alkalinity-p T</b>	tablet	5-300	mg/l CaCO <sub>3</sub>	Acid/Indicator <sup>1,2,5</sup>	560	✓	20
40	<b>Aluminium T</b>	tablet	0.01-0.3	mg/l Al	Eriochrome Cyanine R <sup>2</sup>	530	✓	22
50	<b>Aluminium PP</b>	PP + liquid	0.01-0.25	mg/l Al	Eriochrome Cyanine R <sup>2</sup>	530	–	24
60	<b>Ammonia T</b>	tablet	0.02-1	mg/l N	Indophenol blue <sup>2,3</sup>	610	✓	26
62	<b>Ammonia PP</b>	PP	0.01-0.8	mg/l N	Salicylate <sup>2</sup>	660	–	28
65	<b>Ammonia LR TT</b>	tube test	0.02-2.5	mg/l N	Salicylate <sup>2</sup>	660	–	30
66	<b>Ammonia HR TT</b>	tube test	1-50	mg/l N	Salicylate <sup>2</sup>	660	–	32
85	<b>Boron T</b>	tablet	0.1-2	mg/l B	Azomethine <sup>3</sup>	430	✓	34
80	<b>Bromine T</b>	tablet	0.05-13	mg/l Br <sub>2</sub>	DPD <sup>5</sup>	530	✓	36
81	<b>Bromine PP</b>	PP	0.05-4.5	mg/l Br <sub>2</sub>	DPD <sup>1,2</sup>	530	✓	38
90	<b>Chloride T</b>	tablet	0.5 -25	mg/l Cl <sup>-</sup>	Silver nitrate/ turbidity	530	✓	40
92	<b>Chloride L</b>	liquid	0.5-20	mg/l Cl <sup>-</sup>	Mercurithiocyanate/ Iron nitrate	430	✓	42
100	<b>Chlorine T *</b>	tablet	0.01-6	mg/l Cl <sub>2</sub>	DPD <sup>1,2,3</sup>	530	✓	44, 46
103	<b>Chlorine HR T *</b>	tablet	0.1-10	mg/l Cl <sub>2</sub>	DPD <sup>1,2,3</sup>	530	✓	44, 50
101	<b>Chlorine L *</b>	liquid	0.02-4	mg/l Cl <sub>2</sub>	DPD <sup>1,2,3</sup>	530	✓	44, 54
110	<b>Chlorine PP *</b>	PP	0.02-2	mg/l Cl <sub>2</sub>	DPD <sup>1,2</sup>	530	✓	44, 58
113	<b>Chlorine MR PP *</b>	PP	0.02-3.5	mg/l Cl <sub>2</sub>	DPD <sup>1,2</sup>	530	✓	44, 62
111	<b>Chlorine HR PP *</b>	PP	0.1-8	mg/l Cl <sub>2</sub>	DPD <sup>1,2</sup>	530	–	44, 66
120	<b>Chlorine dioxide T</b>	tablet	0.02-11	mg/l ClO <sub>2</sub>	DPD, Glycine <sup>1,2</sup>	530	✓	70
122	<b>Chlorine dioxide PP</b>	PP	0.04-3.8	mg/l ClO <sub>2</sub>	DPD <sup>1,2</sup>	530	✓	76
105	<b>Chlorine HR (KI) T</b>	tablet	5-200	mg/l Cl <sub>2</sub>	KI/Acid <sup>5</sup>	530	–	80
125	<b>Chromium PP</b>	PP	0.02-2	mg/l Cr	1,5-Diphenyl- carbohydrazide <sup>1,2</sup>	530	–	86
130	<b>COD LR TT</b>	tube test	3 -150	mg/l O <sub>2</sub>	Dichromate/H <sub>2</sub> SO <sub>4</sub> <sup>1,2</sup>	430	–	92

\* = free, combined, total; PP = powder pack; T = tablet;

L = liquid; TT = tube test; LR = low range; MR = middle range; HR = high range;

Vacu-vial® is a registered trade mark of CHEMetrics Inc.



No.	Analysis	Reagent	Range	Displayed as	Method	$\lambda$ [nm]	OTZ	Page
131	<b>COD MR TT</b>	tube test	20 -1500	mg/l O <sub>2</sub>	Dichromate/H <sub>2</sub> SO <sub>4</sub> <sup>1,2</sup>	610	–	94
132	<b>COD HR TT</b>	tube test	0.2 -15	g/l O <sub>2</sub>	Dichromate/H <sub>2</sub> SO <sub>4</sub> <sup>1,2</sup>	610	–	96
204	<b>Colour</b>	direct reading	0-500	Pt-Co units	Pt-Co-Scale <sup>1,2</sup> (APHA)	430	–	98
150	<b>Copper T *</b>	tablet	0.05-5	mg/l Cu	Biquinoline <sup>4</sup>	560	✓	100
151	<b>Copper L*</b>	liquid + powder	0.05-4	mg/l Cu	Bicinchoninate	560	✓	104
153	<b>Copper PP</b>	PP	0.05-5	mg/l Cu	Bicinchoninate	560	✓	110
157	<b>Cyanide</b>	Powder + liquid	0.01-0.5	mg/l CN	Pyridine-barbituric acid <sup>1</sup>	580	✓	112
160	<b>CyA-TEST T</b>	tablet	0-160	mg/l CyA	Melamine	530	✓	114
165	<b>DEHA T</b>	tablet + liquid	20-500	$\mu$ g/l DEHA	PPST <sup>3</sup>	560	✓	116
167	<b>DEHA PP</b>	PP + liquid	20-500	$\mu$ g/l DEHA	PPST <sup>3</sup>	560	–	118
170	<b>Fluoride L</b>	liquid	0.05-2	mg/l F	SPADNS <sup>2</sup>	580	✓	120
210	<b>H<sub>2</sub>O<sub>2</sub> T</b>	tablet	0.03-3	mg/l H <sub>2</sub> O <sub>2</sub>	DPD/catalyst <sup>5</sup>	530	✓	122
213	<b>H<sub>2</sub>O<sub>2</sub> LR L</b>	liquid	1-50	mg/l H <sub>2</sub> O <sub>2</sub>	Titanium tetrachloride/acid	430	–	124
214	<b>H<sub>2</sub>O<sub>2</sub> HR L</b>	liquid	40-500	mg/l H <sub>2</sub> O <sub>2</sub>	Titanium tetrachloride/acid	530	–	126
190	<b>Hardness, Calcium T</b>	tablet	50-900	mg/l CaCO <sub>3</sub>	Murexide <sup>4</sup>	560	–	128
191	<b>Hardness, Calcium 2 T</b>	tablet	0-500	mg/l CaCO <sub>3</sub>	Murexide <sup>4</sup>	560	✓	130
200	<b>Hardness, total T</b>	tablet	2-50	mg/l CaCO <sub>3</sub>	Metallphthalein <sup>3</sup>	560	✓	132
201	<b>Hardness, total HR T</b>	tablet	20-500	mg/l CaCO <sub>3</sub>	Metallphthalein <sup>3</sup>	560	✓	134
205	<b>Hydrazine P</b>	powder	0.05-0.5	mg/l N <sub>2</sub> H <sub>4</sub>	4-(Dimethyl-amino)-benzaldehyde <sup>3</sup>	430	✓	136
206	<b>Hydrazine L</b>	liquid	0.005-0.6	mg/l N <sub>2</sub> H <sub>4</sub>	4-(Dimethyl-amino)-benzaldehyde <sup>3</sup>	430	–	138
207	<b>Hydrazine C</b>	Vacu-vial	0.01-0.7	mg/l N <sub>2</sub> H <sub>4</sub>	PDMAB	430	–	140
215	<b>Iodine T</b>	tablet	0.05-3.6	mg/l I	DPD <sup>5</sup>	530	✓	142
220	<b>Iron T</b>	tablet	0.02-1	mg/l Fe	PPST <sup>3</sup>	560	✓	144, 146
222	<b>Iron PP</b>	PP	0.02-3	mg/l Fe	1,10-Phenanthroline <sup>3</sup>	530	✓	144, 148
223	<b>Iron (TPTZ) PP</b>	PP	0.02-1.8	mg/l Fe	TPTZ	580	–	144, 150

\* = free, combined, total; PP = powder pack; T = tablet; L = liquid; TT = tube test; LR = low range; MR = middle range; HR = high range; Vacu-vial® is a registered trade mark of CHEMetrics Inc.

No.	Analysis	Reagent	Range	Displayed as	Method	$\lambda$ [nm]	OTZ	Page
224	<b>Iron (Fe in Mo) PP</b>	PP	0.01-1.8	mg/l Fe	Fe in Mo	580	–	144, 152
225	<b>Iron LR L</b>	liquid	0.03-2	mg/l Fe	Ferrozine / Thioglycolate	560	✓	144, 154
226	<b>Iron LR 2 L</b>	liquid	0.03-2	mg/l Fe	Ferrozine / Thioglycolate	560	✓	144, 158
227	<b>Iron HR L</b>	liquid	0.1-10	mg/l Fe	Thioglycolate	530	✓	144, 162
240	<b>Manganese T</b>	tablet	0.2-4	mg/l Mn	Formaloxime	530	✓	166
242	<b>Manganese LR PP</b>	PP + liquid	0.01-0.7	mg/l Mn	PAN	560	–	168
243	<b>Manganese HR PP</b>	PP + liquid	0,1-18	mg/l Mn	Periodate oxidation <sup>2</sup>	530	✓	170
245	<b>Manganese L</b>	liquid	0.05-5	mg/l Mn	Formaloxime	430	✓	172
250	<b>Molybdate T</b>	tablet	1-50	mg/l MoO <sub>4</sub>	Thioglycolate <sup>4</sup>	430	✓	174
251	<b>Molybdate LR PP</b>	PP	0,05-5	mg/l MoO <sub>4</sub>	Ternary Complex	610	✓	176
252	<b>Molybdate HR PP</b>	PP	0.5-66	mg/l MoO <sub>4</sub>	Mercaptoacetic acid	430	✓	178
254	<b>Molybdate HR L</b>	liquid	1-100	mg/l MoO <sub>4</sub>	Thioglycolate	430	✓	180
257	<b>Nickel T</b>	tablet	0.1-10	mg/l Ni	Nioxime	560	✓	182
260	<b>Nitrate</b>	tablet + powder	0.08-1	mg/l N	Zinc reduction / NED	530	✓	184
265	<b>Nitrate TT</b>	tube test	1-30	mg/l N	Chromotropic acid	430	–	186
270	<b>Nitrite T</b>	tablet	0.01-0.5	mg/l N	N-(1-Naphthyl)-ethylenediamine <sup>2,3</sup>	560	✓	188
272	<b>Nitrite LR PP</b>	PP	0.01-0.3	mg/l N	Diazotization	530	✓	190
280	<b>Nitrogen, total LR TT</b>	tube test	0.5-25	mg/l N	Persulfate digestion method	430	–	192
281	<b>Nitrogen, total HR TT</b>	tube test	5-150	mg/l N	Persulfate digestion method	430	–	194
290	<b>Oxygen, active T</b>	tablet	0.1-10	mg/l O <sub>2</sub>	DPD	530	✓	198
292	<b>Oxygen, dissolved</b>	Vacu-vial	10-800	$\mu$ g/l O <sub>2</sub>	Rhodazine D™	530	–	200
300	<b>Ozone (DPD) T</b>	tablet	0.02-2	mg/l O <sub>3</sub>	DPD/Glycine <sup>5</sup>	530	✓	202
70	<b>PHMB T</b>	tablet	2-60	mg/l PHMB	Buffer/Indicator	560	✓	208
320	<b>Phosphate, T ortho LR</b>	tablet	0.05-4	mg/l PO <sub>4</sub>	Ammonium-molybdate <sup>2,3</sup>	660	✓	210, 212
321	<b>Phosphate, ortho HR T</b>	tablet	1-80	mg/l PO <sub>4</sub>	Vanado-molybdate <sup>2</sup>	430	✓	210, 214

\* = free, combined, total; PP = powder pack; T = tablet;  
L = liquid; TT = tube test; LR = low range; MR = middle range; HR = high range;  
Vacu-vial® is a registered trade mark of CHEMetrics Inc.

No.	Analysis	Reagent	Range	Displayed as	Method	$\lambda$ [nm]	OTZ	Page
323	<b>Phosphate, PP ortho</b>	PP	0.06-2.5	mg/l PO <sub>4</sub>	Molybdate/Ascorbic acid <sup>2</sup>	660	✓	210, 216
324	<b>Phosphate, ortho TT</b>	tube test	0.06-5	mg/l PO <sub>4</sub>	Molybdate/Ascorbic acid <sup>2</sup>	660	–	210, 218
327	<b>Phosphate 1 C, ortho</b>	Vacu-vial	5-40	mg/l PO <sub>4</sub>	Vanado-molybdate <sup>2</sup>	430	–	210, 220
328	<b>Phosphate 2 C, ortho</b>	Vacu-vial	0.05-5	mg/l PO <sub>4</sub>	Stannous chloride <sup>2</sup>	660	–	210, 222
325	<b>Phosphate, hydr. TT</b>	tube test	0.02-1.6	mg/l P	Acid digestion, Ascorbic acid <sup>2</sup>	660	–	210, 224
326	<b>Phosphate, total TT</b>	tube test	0.02-1.1	mg/l P	Acid persulf digestion, Ascorbic acid <sup>2</sup>	660	–	210, 226
334	<b>Phosphate LR L</b>	liquid	0.1-10	mg/l PO <sub>4</sub>	Phosphomolybdic acid/Ascorbic acid	660	✓	210, 228
335	<b>Phosphate HR L</b>	liquid	5-80	mg/l PO <sub>4</sub>	Vanado-molybdate	430	✓	210, 232
316	<b>Phosphonate PP</b>	PP	0-125	mg/l	Persulfate UV-Oxidation	660	–	236
329	<b>pH-Value LR T</b>	tablet	5.2-6.8	—	Bromocresolpurple <sup>5</sup>	560	✓	240
330	<b>pH-Value T</b>	tablet	6.5-8.4	—	Phenolred <sup>5</sup>	560	✓	242
331	<b>pH-Value L</b>	liquid	6.5-8.4	—	Phenolred <sup>5</sup>	560	✓	244
332	<b>pH-Value HR T</b>	tablet	8.0-9.6	—	Thymolblue <sup>5</sup>	560	✓	246
338	<b>Polyacrylate L</b>	liquid	1-30	mg/l Polyacryl	Turbidity	660	✓	248
340	<b>Potassium T</b>	tablet	0.7-16	mg/l K	Tetraphenylborate-Turbidity <sup>4</sup>	430	✓	252
350	<b>Silica T</b>	tablet	0.05-4	mg/l SiO <sub>2</sub>	Silicomolybdate <sup>2,3</sup>	660	✓	254
351	<b>Silica LR PP</b>	PP	0.1-1.6	mg/l SiO <sub>2</sub>	Heteropolyblue <sup>2</sup>	660	–	256
352	<b>Silica HR PP</b>	PP	1-90	mg/l SiO <sub>2</sub>	Silicomolybdate <sup>2</sup>	430	✓	258
353	<b>Silica L</b>	liquid + powder	0.1-8	mg/l SiO <sub>2</sub>	Heteropolyblue <sup>2</sup>	660	✓	260
212	<b>Sodium hypochlorite T</b>	tablet	0.2-16	% NaOCl	Potassium iodide <sup>5</sup>	530	✓	262
355	<b>Sulfate T</b>	tablet	5-100	mg/l SO <sub>4</sub>	Bariumsulfate-Turbidity	610	✓	264
360	<b>Sulfate PP</b>	PP	5-100	mg/l SO <sub>4</sub>	Bariumsulfate-Turbidity <sup>2</sup>	530	✓	266
365	<b>Sulfide</b>	tablet	0.04-0.5	mg/l S	DPD/Catalyst <sup>3,4</sup>	660	✓	268
370	<b>Sulfite T</b>	tablet	0.1-5	mg/l SO <sub>3</sub>	DTNB	430	✓	270

\* = free, combined, total; PP = powder pack; T = tablet;  
L = liquid; TT = tube test; LR = low range; MR = middle range; HR = high range;  
Vacu-vial® is a registered trade mark of CHEMetrics Inc.

No.	Analysis	Reagent	Range	Displayed as	Method	$\lambda$ [nm]	OTZ	Page
376	<b>Surfactants, TT (anionic)</b>	tube test	0.05-2	mg/l SDSA	methylene blue <sup>6,1</sup>	660	–	272
377	<b>Surfactants TT (nonionic)</b>	tube test	0.1-7.5	mg/l Triton <sup>®</sup> X-100	TBPE <sup>6</sup>	610	–	274
378	<b>Surfactants TT (cationic)</b>	tube test	0.05-1.5	mg/l CTAB	disulfine blue <sup>6,1</sup>	610	–	276
384	<b>Suspended Solids</b>	direct reading	0-750	mg/l TSS	photometric	660	–	278
380	<b>TOC LR TT</b>	tube test	5.0-80.0	mg/l TOC	H <sub>2</sub> SO <sub>4</sub> /Persulfate / Indicator <sup>6</sup>	610	–	280
381	<b>TOC HR TT</b>	tube test	50-800	mg/l TOC	H <sub>2</sub> SO <sub>4</sub> /Persulfate / Indicator <sup>6</sup>	610	–	282
388	<b>Tolyltriazole PP</b>	PP	1-16	mg/l Benzo triazole	Catalysed UV photolysis	430	✓	284
386	<b>Turbidity</b>	direct reading	10-1000	FAU	Attenuated Radiation Method	530	–	286
390	<b>Urea T</b>	tablet + liquid	0.1-2.5	mg/l Urea	Indophenol/ Urease	610	✓	288
400	<b>Zinc T</b>	tablet	0.02 -0.9	mg/l Zn	Zincon <sup>3</sup>	610	–	290
405	<b>Zinc L</b>	liquid + powder	0.1 -2.5	mg/l Zn	Zincon / EDTA	610	✓	292

\* = free, combined, total; PP = powder pack; T = tablet;  
L = liquid; TT = tube test; LR = low range; MR = middle range; HR = high range;  
Vacu-vial<sup>®</sup> is a registered trade mark of CHEMetrics Inc.

## 1.1 Methods

The precision of Lovibond® Reagent Systems (tablets, powder packs and tube tests) is identical to the precision specified in standards literature such as American Standards (AWWA), ISO etc.

Most of the data referred to in these standard methods relates to Standard Solutions. Therefore they are not readily applicable to drinking-, boiler- or waste-water, since various interferences can have a major influence on the accuracy of the method.

For this reason we don't state such potentially misleading data.

Due to the fact that each sample is different, the only way to check the tolerances ('precision') is the Standard Additions Method.

According to this method, first the original sample is tested. Then further samples (2 to 4) are taken and small amounts of a Standard Solution are added, and further results are obtained. The amounts added range from approximately half, up to double the amount present in the sample itself.

These supplementary results make it possible to estimate the actual concentration of the original sample by comparison.

## Literature

The reagent formulations are based on internationally recognised test methods. Some are described in national and/or international guidelines.

1. Deutsche Einheitsverfahren zur Wasser-, Abwasser- und Schlammuntersuchung
2. Standard Methods for the Examination of Water and Wastewater; 18th Edition, 1992
3. Photometrische Analysenverfahren, Schwedt, Wissenschaftliche Verlagsgesellschaft mbH, Stuttgart 1989
4. Photometrische Analyse, Lange / Vejdelek, Verlag Chemie 1980
5. Colorimetric Chemical Analytical Methods, 9th Edition, London
6. adapted from Merck, for more information see instructions delivered with the test

## Notes for searching:

### **OTZ (OneTimeZero) switching on and off, see Mode 55, page 335**

Active Oxygen	->	Oxygen, activ
Alkalinity-m	->	Alkalinity, total
Biguanide	->	PHMB
Calcium Hardness	->	Hardness, Calcium
Cyanuric acid	->	CyA-TEST
H <sub>2</sub> O <sub>2</sub>	->	Hydrogen peroxide
Monochloramine	->	Chloramine, mono
m-Value	->	Alkalinity, total
Total Hardness	->	Hardness, total
p-Value	->	Alkalinity-p
Silicon dioxide	->	Silica
total Alkalinity	->	Alkalinity, total
total Hardness	->	Hardness, total

**Langelier Saturation Index (Water Balance)** -> **Mode function 70**

## 1.1 Methods

2

0

### Acid demand to pH 4.3 with Tablet

0.1 – 4 mmol/l



prepare Zero  
press ZERO

1. Fill a clean vial (24 mm Ø) with **10 ml of the water sample**, close tightly with the cap.
2. Place the vial in the sample chamber making sure that the  $\Sigma$  marks are aligned.
3. Press **ZERO** key.
4. Remove the vial from the sample chamber.
5. Add **one ALKA-M-PHOTOMETER tablet** straight from the foil to the water sample and crush the tablet using a clean stirring rod.
6. Close the vial tightly with the cap and swirl several times until the tablet is dissolved.
7. Place the vial in the sample chamber making sure that the  $\Sigma$  marks are aligned.
8. Press **TEST** key.

Zero accepted  
prepare Test  
press TEST

The result is shown in the display as Acid demand to pH 4.3 in mmol/l.

## 1.1 Methods

**Notes:**

1. The terms total Alkalinity, Alkalinity-m, m-Value and Acid demand to pH 4.3 are identical.
2. For accurate results exactly 10 ml of water sample must be taken for the test.

<b>Reagent / Accessories</b>	<b>Form of reagent/Quantity</b>	<b>Order-No.</b>
ALKA-M-PHOTOMETER	Tablet / 100	513210BT

## 1.1 Methods

3

0

### Alkalinity, total = Alkalinity-m = m-Value with Tablet

5 – 200 mg/l CaCO<sub>3</sub>

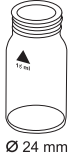

1. Fill a clean vial (24 mm Ø) with **10 ml of the water sample**, close tightly with the cap.
2. Place the vial in the sample chamber making sure that the  $\Sigma$  marks are aligned.
3. Press **ZERO** key.
4. Remove the vial from the sample chamber.
5. Add **one ALKA-M-PHOTOMETER tablet** straight from the foil to the water sample and crush the tablet using a clean stirring rod.
6. Close the vial tightly with the cap and swirl several times until the tablet is dissolved.
7. Place the vial in the sample chamber making sure that the  $\Sigma$  marks are aligned.
8. Press **TEST** key.

prepare Zero  
press ZERO

Zero accepted  
prepare Test  
press TEST

The result is shown in the display as total Alkalinity.



## 1.1 Methods

### Notes:

1. The terms total Alkalinity, Alkalinity-m, m-Value and Alkalinity to pH 4.3 are identical.
2. For accurate results exactly 10 ml of water sample must be taken for the test.
3. Conversion table:

	Acid demand to pH 4.3 DIN 38 409 (K54.3)	German °dH*	English °eH*	French °fH*
1 mg/l CaCO <sub>3</sub>	0.02	0.056	0.07	0.1

\*Carbonate hardness (reference = Hydrogencarbonate-anions)

Example:

$$10 \text{ mg/l CaCO}_3 = 10 \text{ mg/l} \times 0.056 = 0.56 \text{ °dH}$$

$$10 \text{ mg/l CaCO}_3 = 10 \text{ mg/l} \times 0.02 = 0.2 \text{ mmol/l}$$

4. ▲ CaCO<sub>3</sub>  
°dH  
°eH  
°fH  
▼ °aH

Reagent / Accessories	Form of reagent/Quantity	Order-No.
ALKA-M-PHOTOMETER	Tablet / 100	513210BT

## 1.1 Methods

3

1

### Alkalinity HR, total = Alkalinity-m HR = m-Value HR with Tablet

5 – 500 mg/l CaCO<sub>3</sub>

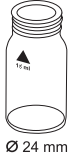

Ø 24 mm

1. Fill a clean vial (24 mm Ø) with **10 ml of the water sample**, close tightly with the cap.
2. Place the vial in the sample chamber making sure that the  $\Sigma$  marks are aligned.

prepare Zero  
press ZERO

3. Press **ZERO** key.
4. Remove the vial from the sample chamber.
5. Add **one ALKA-M-HR PHOTOMETER tablet** straight from the foil to the water sample and crush the tablet using a clean stirring rod.
6. Close the vial tightly with the cap and swirl several times until the tablet is dissolved.

Countdown  
1:00  
start: ↵

7. Press **[↵]** key.  
Wait for a **reaction period of 1 minute**.

8. **Remix the solution.**

9. Place the vial in the sample chamber making sure that the  $\Sigma$  marks are aligned.

Zero accepted  
prepare Test  
press TEST

10. Press **TEST** key.

The result is shown in the display as total Alkalinity.

## 1.1 Methods

### Notes:

1. For verification of the result look carefully at the bottom of the vial. If a thin yellow layer forms, then mix the vial again. This ensures that reaction is complete. Reread the result.
2. Conversion table:

	Acid demand to pH 4.3 DIN 38 409 (K <sub>S4.3</sub> )	German °dH*	English °eH*	French °fH*
1 mg/l CaCO <sub>3</sub>	0.02	0.056	0.07	0.1

\*Carbonate hardness (reference = Hydrogencarbonate-anions)

Example:

$$10 \text{ mg/l CaCO}_3 = 10 \text{ mg/l} \times 0.056 = 0.56 \text{ °dH}$$

$$10 \text{ mg/l CaCO}_3 = 10 \text{ mg/l} \times 0.02 = 0.2 \text{ mmol/l}$$

3. ▲ CaCO<sub>3</sub>  
°dH  
°eH  
°fH  
▼ °aH

Reagent / Accessories	Form of reagent/Quantity	Order-No.
ALKA-M-HR-PHOTOMETER	Tablet / 100	513240BT

## 1.1 Methods

3

5

### Alkalinity-p = p-value with Tablet

5 – 300 mg/l CaCO<sub>3</sub>



1. Fill a clean vial (24 mm Ø) with **10 ml of the water sample**, close tightly with the cap.
2. Place the vial in the sample chamber making sure that the X marks are aligned.
3. Press **ZERO** key.
4. Remove the vial from the sample chamber.
5. Add **one ALKA-P-PHOTOMETER tablet** straight from the foil to the water sample and crush the tablet using a clean stirring rod.
6. Close the vial tightly with the cap and swirl several times until the tablet is dissolved.
7. Place the vial in the sample chamber making sure that the X marks are aligned.

prepare Zero  
press ZERO

8. Press **TEST** key.  
Wait for a **reaction period of 5 minutes**.

Zero accepted  
prepare Test  
press TEST

Countdown  
5:00

After the reaction period is finished the measurement starts automatically.

The result is shown in the display as Alkalinity-p.

# 1.1 Methods

## Notes

1. The terms Alkalinity-p, p-Value and Alkalinity to pH 8.2 are identical.
2. For accurate test results exactly 10 ml of water sample must be taken for the test.
3. This method was developed from a volumetric procedure for the determination of Alkalinity-p. Due to undefined conditions, the deviations from the standardised method may be greater.
4. Conversion table:

	mg/l CaCO <sub>3</sub>	°dH	°fH	°eH
1 mg/l CaCO <sub>3</sub>	----	0.056	0.10	0.07
1 °dH	17.8	----	1.78	1.25
1 °fH	10.0	0.56	----	0.70
1 °eH	14.3	0.80	1.43	----

5. ▲ CaCO<sub>3</sub>  
     °dH  
     °eH  
     °fH  
     ▼ °aH

6. By determining Alkalinity-p and Alkalinity-m it is possible to classify the alkalinity as Hydroxide, Carbonate and Hydrogencarbonate.

The following differentiation is only valid if:

- a) no other alkalis are present and
- b) Hydroxide und Hydrogen are not present in the same water sample.

If condition b) is not fulfilled please get additional information from "Deutsche Einheitsverfahren zur Wasser-, Abwasser- und Schlammuntersuchung, D 8".

Case 1: Alkalinity-p = 0

Hydrogen carbonate = m

Carbonate = 0

Hydroxide = 0

Case 2: Alkalinity-p > 0 and Alkalinity-m > 2p

Hydrogen carbonate = m – 2p

Carbonate = 2p

Hydroxide = 0

Case 3: Alkalinity-p > 0 and Alkalinity-m < 2p

Hydrogen carbonate = 0

Carbonate = 2m – 2p

Hydroxide = 2p – m

Reagent / Accessories	Form of reagent/Quantity	Order-No.
ALKA-P-PHOTOMETER	Tablet / 100	513230BT

## 1.1 Methods

4

0

### Aluminium with Tablet

0.01 – 0.3 mg/l Al



prepare Zero  
press ZERO

1. Fill a clean vial (24 mm Ø) with **10 ml of the water sample**, close tightly with the cap.
2. Place the vial in the sample chamber making sure that the X marks are aligned.
3. Press **ZERO** key.
4. Remove the vial from the sample chamber.
5. Add **one ALUMINIUM No. 1 tablet** straight from the foil to the water sample and crush the tablet using a clean stirring rod (dissolve the tablet).
6. Add **one ALUMINIUM No. 2 tablet** straight from the foil to the same water sample and crush the tablet using a clean stirring rod.
7. Close the vial tightly with the cap and swirl gently several times until the tablets are dissolved.
8. Place the vial in the sample chamber making sure that the X marks are aligned.
9. Press **TEST** key.  
Wait for a **reaction period of 5 minutes**.

Zero accepted  
prepare Test  
press TEST

Countdown  
5:00

After the reaction period is finished the measurement starts automatically.

The result is shown in the display in mg/l Aluminium.

## 1.1 Methods

### Notes:

1. Before use, clean the vials and the accessories with Hydrochloric acid (approx. 20%). Rinse them thoroughly with deionised water.
2. To get accurate results the sample temperature must be between 20°C and 25°C.
3. A low test result may be given in the presence of Fluorides and Polyphosphates. The effect of this is generally insignificant unless the water has fluoride added artificially. In this case, the following table should be used:

Fluoride [mg/l F]	Displayed value: Aluminium [mg/l Al]					
	0.05	0.10	0.15	0.20	0.25	0.30
0.2	0.05	0.11	0.16	0.21	0.27	0.32
0.4	0.06	0.11	0.17	0.23	0.28	0.34
0.6	0.06	0.12	0.18	0.24	0.30	0.37
0.8	0.06	0.13	0.20	0.26	0.32	0.40
1.0	0.07	0.13	0.21	0.28	0.36	0.45
1.5	0.09	0.20	0.29	0.37	0.48	---

Example: If the result of Aluminium determination is 0.15 mg/l Al and the Fluoride concentration is known to be 0.4 mg/l F, the true concentration of Aluminium is 0.17 mg/l Al.

4. A special tablet ingredient prevents effects on the measurement due to iron and manganese.
5. ▲ Al  
▼ Al<sub>2</sub>O<sub>3</sub>

Reagent / Accessories	Form of reagent/Quantity	Order-No.
<b>Set</b> ALUMINIUM No. 1 / No. 2	Tablet / per 100 inclusive stirring rod	517601BT
ALUMINIUM No. 1	Tablet / 100	515460BT
ALUMINIUM No. 2	Tablet / 100	515470BT

## 1.1 Methods

5

0

### Aluminium with Vario Powder Pack

0.01 – 0.25 mg/l Al



Ø 24 mm

Use two clean vials (24 mm Ø) and mark one as blank for zeroing.

1. Fill **20 ml of the water sample** in a 100 ml beaker.
2. Add the contents of **one Vario Aluminium ECR F20 Powder Pack** straight from the foil to the water sample.
3. Dissolve the powder using a clean stirring rod.
4. Press **[↵]** key.  
Wait for a **reaction period of 30 seconds**.

Countdown 1  
0:30  
start: ↵

After the reaction period is finished proceed as follows:

5. Add the contents of **one Vario Hexamine F20 Powder Pack** straight from the foil to the same water sample.
6. Dissolve the powder using a clean stirring rod.
7. Add **1 drop of Vario Aluminium ECR Masking Reagent** in the vial marked as blank.
8. Add 10 ml of the prepared water sample to the vial (this is the blank).
9. Add the remaining 10 ml of the prepared water sample in the second clean vial (this is the sample).
10. Close the vials tightly with the caps and swirl several times to mix the contents.

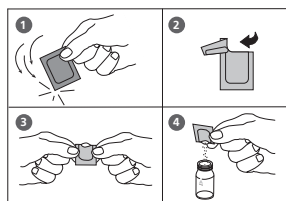

Countdown 2  
5:00  
start: ↵

11. Press **[↵]** key.  
Wait for a **reaction period of 5 minutes**.

After the reaction period is finished proceed as follows:



## 1.1 Methods

**prepare Zero  
press ZERO**

12. Place the vial (the blank) in the sample chamber making sure that the  $\Sigma$  marks are aligned.

13. Press **ZERO** key.

14. Remove the vial from the sample chamber.

15. Place the vial (the sample) in the sample chamber making sure that the  $\Sigma$  marks are aligned.

**Zero accepted  
prepare Test  
press TEST**

16. Press **TEST** key.

The result is shown in the display in mg/l Aluminium.

### Notes:

- Before use, clean the vials and the accessories with Hydrochloric acid (approx. 20%). Rinse them thoroughly with deionised water.
- To get accurate results the sample temperature must be between 20°C and 25°C.
- A low test result may be given in the presence of Fluorides and Polyphosphates. The effect of this is generally insignificant unless the water has fluoride added artificially. In this case, the following table should be used:

Fluoride [mg/l F]	Displayed value: Aluminium [mg/l Al]					
	0.05	0.10	0.15	0.20	0.25	0.30
0.2	0.05	0.11	0.16	0.21	0.27	0.32
0.4	0.06	0.11	0.17	0.23	0.28	0.34
0.6	0.06	0.12	0.18	0.24	0.30	0.37
0.8	0.06	0.13	0.20	0.26	0.32	0.40
1.0	0.07	0.13	0.21	0.28	0.36	0.45
1.5	0.09	0.20	0.29	0.37	0.48	---

Example: If the result of Aluminium determination is 0.15 mg/l Al and the Fluoride concentration is known to be 0.4 mg/l F, the true concentration of Aluminium is 0.17 mg/l Al.

4. ▲ Al  
▼ Al<sub>2</sub>O<sub>3</sub>

Reagent / Accessories	Form of reagent/Quantity	Order-No.
<b>Set</b> VARIO Aluminium ECR F20 VARIO Aluminium Hexamine F 20 VARIO Aluminium ECR Masking Reagent	Powder Pack / 100 Powder Pack / 100 Liquid reagent / 25 ml	<b>535000</b>

## 1.1 Methods

6

0

### Ammonia with Tablet

0.02 – 1 mg/l N



Ø 24 mm

prepare Zero  
press ZERO

1. Fill a clean vial (24 mm Ø) with **10 ml of the water sample**, close tightly with the cap.
2. Place the vial in the sample chamber making sure that the  $\Sigma$  marks are aligned.
3. Press **ZERO** key.

4. Remove the vial from the sample chamber.

5. Add **one AMMONIA No. 1 tablet** straight from the foil to the water sample and crush the tablet using a clean stirring rod.

6. Add **one AMMONIA No. 2 tablet** straight from the foil to the same water sample and crush the tablet using a clean stirring rod.

7. Close the vial tightly with the cap and swirl several times until the tablets are dissolved.

8. Place the vial in the sample chamber making sure that the  $\Sigma$  marks are aligned.

9. Press **TEST** key.  
Wait for a **reaction period of 10 minutes**.

Zero accepted  
prepare Test  
press TEST

Countdown  
10:00

After the reaction period is finished the measurement starts automatically.

The result is shown in the display in mg/l Ammonia as N.

## 1.1 Methods

### Notes:

1. The tablets must be added in the correct sequence.
2. The AMMONIA No. 1 tablet will only dissolve completely after the AMMONIA No. 2 tablet has been added.
3. The temperature of the sample is important for full colour development.  
At a temperature below 20°C the reaction period is 15 minutes.
4. Sea water samples:  
Ammonia conditioning reagent is required when testing sea water or brackish water samples to prevent precipitation of salts.  
Fill the test tube with the sample to the 10 ml mark and add one level spoonful of Conditioning Powder. Mix to dissolve, then continue as described in the test instructions.
5. Conversion:  

$$\text{mg/l NH}_4 = \text{mg/l N} \times 1.29$$

$$\text{mg/l NH}_3 = \text{mg/l N} \times 1.22$$
6. ▲ N  
     NH<sub>4</sub>  
     ▼ NH<sub>3</sub>

Reagent / Accessories	Form of reagent/Quantity	Order-No.
<b>Set</b> AMMONIA No. 1 / No. 2	Tablet / per 100 inclusive stirring rod	517611BT
AMMONIA No. 1	Tablet / 100	512580BT
AMMONIA No. 2	Tablet / 100	512590BT
Ammonia conditioning reagent (Sea water samples)	(approx. 50 tests) powder / 15 g	460170

## 1.1 Methods

6

2

### Ammonia with Vario Powder Pack

0.01 – 0.8 mg/l N



Ø 24 mm

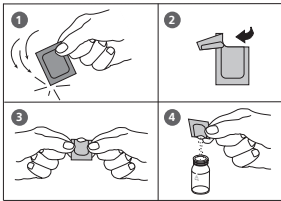

Countdown 1  
3:00  
start: ↵

Use two clean vials (24 mm Ø) and mark one as blank for zeroing.

1. Fill a clean vial (24 mm Ø) with **10 ml of deionised water** (this is the blank).
2. Fill the other clean vial (24 mm Ø) with **10 ml of the water sample** (this is the sample).
3. Add the contents of **one Vario Ammonia Salicylate F10 Powder Pack** straight from the foil to each vial.
4. Close the vials with the caps and shake to mix the contents.
5. Press **[↵]** key.  
Wait for a **reaction period of 3 minutes**.

After the reaction period is finished proceed as follows:

6. Add the contents of **one Vario Ammonia Cyanurate F10 Powder Pack** straight from the foil to each sample.
7. Close the vials tightly with the caps and shake thoroughly until the reagent is dissolved completely.
8. Press **[↵]** key.  
Wait for a **reaction period of 15 minutes**.

After the reaction period is finished proceed as follows:

9. Place the vial (the blank) in the sample chamber making sure that the **X** marks are aligned.
10. Press **ZERO** key.
11. Remove the vial from the sample chamber.
12. Place the vial (the sample) in the sample chamber making sure that the **X** marks are aligned.
13. Press **TEST** key.

The result is shown in the display in mg/l Ammonia as N.

Countdown 2  
15:00  
start: ↵

prepare Zero  
press ZERO

Zero accepted  
prepare Test  
press TEST

## 1.1 Methods

### Notes:

- Extremely basic or acidic water samples should be adjusted with 0.5 mol/l (1 N) Sulfuric acid solution or 1 mol/l (1 N) Sodium hydroxide solution to pH 7.
- Interferences:

Interfering substance	Interference levels and treatments
Calcium	greater than 1000 mg/l $\text{CaCO}_3$
Iron	Interferes at all levels. Correct as follows: a) determine the concentration of iron present in the sample by performing a total Iron test b) add the same iron concentration as determined to the deionised water (step 1). The interference will be blanked out successfully.
Magnesium	greater than 6000 mg/l $\text{CaCO}_3$
Nitrate	greater than 100 mg/l $\text{NO}_3\text{-N}$
Nitrite	greater than 12 mg/l $\text{NO}_2\text{-N}$
Phosphate	greater than 100 mg/l $\text{PO}_4\text{-P}$
Sulfate	greater than 300 mg/l $\text{SO}_4$
Sulfide	intensifies the colour
Glycine, Hydrazine, Colour, Turbidity	Less common interferences such as Hydrazine and Glycine will cause intensified colours in the prepared sample. Turbidity and colour will give erroneous high values. Samples with severe interferences require distillation.

- ▲ N  
NH<sub>4</sub>  
▼ NH<sub>3</sub>

Reagent / Accessories	Form of reagent/Quantity	Order-No.
<b>Set</b> VARIO Ammonia Salicylate F10 VARIO Ammonia Cyanurate F10	Powder Pack / per 100 PP	535500

## 1.1 Methods

### 6 5 Ammonia LR with Vario Tube Test

0.02 – 2.5 mg/l N



Insert the adapter for 16 mm Ø vials.

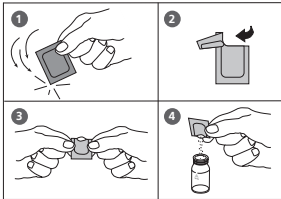

1. Open one white capped reaction vial and add **2 ml deionised water** (this is the blank).
2. Open another white capped reaction vial and add **2 ml of the water sample** (this is the sample).
3. Add the contents of **one Vario Ammonia Salicylate F5 Powder Pack** straight from the foil into each vial.
4. Add the contents of **one Vario Ammonia Cyanurate F5 Powder Pack** straight from the foil into each vial.
5. Close the vials tightly with the caps and shake thoroughly until the reagent is dissolved completely.

Countdown 1  
20:00  
start: ↴

6. Press **[↴]** key.  
Wait for a **reaction period of 20 minutes**.

After the reaction period is finished proceed as follows:

7. Place the vial (the blank) in the sample chamber making sure that the marks are **Δ** aligned.
8. Press **ZERO** key.
9. Remove the vial from the sample chamber.
10. Place the vial (the sample) in the sample chamber making sure that the marks are **Δ** aligned.
11. Press **TEST** key.

prepare Zero  
press ZERO

Zero accepted  
prepare Test  
press TEST

The result is shown in the display in mg/l Ammonia as N.

## 1.1 Methods

### Notes:

1. Strong alkaline or acidic water samples must be adjusted to approx. pH 7 before analysis (use 1 mol/l Hydrochloric acid resp. 1 mol/l Sodium hydroxide).
2. Iron interferes with the test. The interferences will be eliminated as follows:  
Determine the amount of total iron present in the water sample. To produce the blank add an iron standard solution with the same iron concentration to the vial (point 1) instead of deionised water
3. Conversion:  
 $\text{mg/l NH}_4 = \text{mg/l N} \times 1.29$   
 $\text{mg/l NH}_3 = \text{mg/l N} \times 1.22$
4. ▲ N  
    NH<sub>4</sub>  
    ▼ NH<sub>3</sub>

Reagent / Accessories	Form of reagent/Quantity	Order-No.
<b>Set</b> VARIO Ammonia Salicylate F5 VARIO Ammonia Cyanurate F5 VARIO Am Diluent Reagent LR VARIO deionised water	<b>Set</b> Powder Pack / 50 Powder Pack / 50 Reaction tube / 50 100 ml	535600

## 1.1 Methods

6

6

### Ammonia HR with Vario Tube Test

1 – 50 mg/l N



Insert the adapter for 16 mm Ø vials.

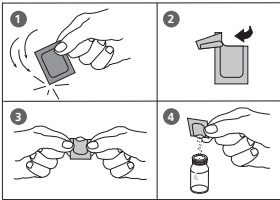

1. Open one white capped reaction vial and add **0.1 ml deionised water** (this is the blank).
2. Open another white capped reaction vial and add **0.1 ml of the water sample** (this is the sample).
3. Add the contents of **one Vario Ammonia Salicylate F5 Powder Pack** straight from the foil into each vial.
4. Add the contents of **one Vario Ammonia Cyanurate F5 Powder Pack** straight from the foil into each vial.
5. Close the vials tightly with the caps and shake thoroughly until the reagent is dissolved completely.

Countdown 1  
20:00  
start: ↴

6. Press **[↴]** key.  
Wait for a **reaction period of 20 minutes**.

After the reaction period is finished proceed as follows:

7. Place the vial (the blank) in the sample chamber making sure that the marks are **Δ** aligned.
8. Press **ZERO** key.
9. Remove the vial from the sample chamber.
10. Place the vial (the sample) in the sample chamber making sure that the marks are **Δ** aligned.
11. Press **TEST** key.

prepare Zero  
press ZERO

Zero accepted  
prepare Test  
press TEST

The result is shown in the display in mg/l Ammonia as N.



## 1.1 Methods

### Notes:

1. Strong alkaline or acidic water samples must be adjusted to approx. pH 7 before analysis (use 1 mol/l Hydrochloric acid resp. 1 mol/l Sodium hydroxide).
2. If chlorine is known to be present, add one drop of 0.1 mol/l Sodium thiosulfate for each 0.3 mg/l Cl<sub>2</sub> in a one litre water sample.
3. Iron interferes with the test. The interferences will be eliminated as follows:  
Determine the amount of total iron present in the water sample. Add an iron standard solution with the same concentration to the vial (point 1) instead of deionised water to produce the blank.
4. Conversion:  

$$\text{mg/l NH}_4 = \text{mg/l N} \times 1.29$$

$$\text{mg/l NH}_3 = \text{mg/l N} \times 1.22$$
5. ▲ N  
     NH<sub>4</sub>  
     ▼ NH<sub>3</sub>

Reagent / Accessories	Form of reagent/Quantity	Order-No.
<b>Set</b> VARIO Ammonia Salicylate F5 VARIO Ammonia Cyanurate F5 VARIO Am Diluent Reagent HR VARIO deionised water	<b>Set</b> Powder Pack / 50 Powder Pack / 50 Reaction tube / 50 100 ml	535650

## 1.1 Methods

8

5

### Boron with Tablet

0.1 – 2 mg/l B



Ø 24 mm

prepare Zero  
press ZERO

1. Fill a clean vial (24 mm Ø) with **10 ml of the water sample**, close tightly with the cap.
2. Place the vial in the sample chamber making sure that the  $\Sigma$  marks are aligned.
3. Press **ZERO** key.
4. Remove the vial from the sample chamber.
5. Add **one BORON No. 1 tablet** straight from the foil to the water sample and crush the tablet using a clean stirring rod and dissolve the tablet.
6. Add **one BORON No. 2 tablet** straight from the foil to the same water sample and crush the tablet using a clean stirring rod.
7. Close the vial tightly with the cap and swirl several times until the tablets are dissolved.
8. Place the vial in the sample chamber making sure that the  $\Sigma$  marks are aligned.

Zero accepted  
prepare Test  
press TEST

Countdown  
20:00

9. Press **TEST** key.

Wait for a **reaction period of 20 minutes**.

After the reaction period is finished the measurement starts automatically.

The result is shown in the display in mg/l Boron.

## 1.1 Methods

### Notes:

1. The tablets must added in the correct sequence.
2. The sample solution should have a pH value between 6 and 7.
3. Interferences are prevented by the presence of EDTA in the tablets.
4. The rate of colour development depends on the temperature. The temperature of the sample must be  $20^{\circ}\text{C} \pm 1^{\circ}\text{C}$ .
5.  $\blacktriangle$  B  
 $\blacktriangledown$   $\text{H}_3\text{BO}_3$

Reagent / Accessories	Form of reagent/Quantity	Order-No.
<b>Set</b> Bor No. 1 / No. 2	Tablet / per 100 inclusive stirring rod	517681BT
BORON No. 1	Tablet / 100	515790
BORON No. 2	Tablet / 100	515800BT

## 1.1 Methods

8

0

### Bromine with Tablet

0.05 – 13 mg/l Br<sub>2</sub>



Ø 24 mm

prepare Zero  
press ZERO

1. Fill a clean vial (24 mm Ø) with **10 ml of the water sample**, close tightly with the cap.
2. Place the vial in the sample chamber making sure that the X marks are aligned.
3. Press **ZERO** key.
4. Remove the vial from the sample chamber and **empty it, leaving a few drops remaining in the vial.**
5. Add **one DPD No. 1 tablet** straight from the foil and crush the tablet using a clean stirring rod (note 5).
6. Add water sample to the 10 ml mark.
7. Close the vial tightly with the cap and swirl several times until the tablet is dissolved.
8. Place the vial in the sample chamber making sure that the X marks are aligned.

Zero accepted  
prepare Test  
press TEST

9. Press **TEST** key.

The result is shown in the display in mg/l Bromine.

## 1.1 Methods

### Notes:

1. Vial cleaning:  
As many household cleaners (e.g. dishwasher detergent) contain reducing substances, the subsequent determination of Bromine may show lower results. To avoid any measurement errors, only use glassware free of Chlorine demand.  
Preparation: Put all applicable glassware into Sodium hypochlorite solution (0.1 g/l) for one hour, then rinse all glassware thoroughly with deionised water.
2. Preparing the sample:  
When preparing the sample, the loss of Bromine, e.g. by pipetting or shaking, must be avoided. The analysis must take place immediately after taking the sample.
3. The DPD colour development is carried out at a pH value of 6.2 to 6.5. The reagent tablet therefore contains a buffer for the pH adjustment. Strong alkaline or acidic water samples must be adjusted between pH 6 and pH 7 before the reagent is added (use 0.5 mol/l Sulfuric acid resp. 1 mol/l Sodium hydroxide).
4. Exceeding the measuring range:  
Concentrations above 22 mg/l Bromine can lead to results showing 0 mg/l.  
In this case, the water sample must be diluted with water free of Bromine.  
10 ml of the diluted sample should be mixed with the reagent and the measurement repeated.
5. Depending on the preparation of the dosed bromine, bromine compounds may not react completely with the DPD No.1 tablet. In this case, the DPD No.3 tablet should be added under observation with a reaction time of 2 minutes. Please follow the directions of the bromine compound manufacturer where necessary.
6. Oxidising agents such as Chlorine, Ozone etc. interfere as they react in the same way as Bromine.

Reagent / Accessories	Form of reagent/Quantity	Order-No.
DPD No. 1	Tablet / 100	511050BT
DPD No. 3	Tablet / 100	511080BT

## 1.1 Methods

8

1

### Bromine with Powder Pack

0.05 – 4,5 mg/l Br<sub>2</sub>



Ø 24 mm

1. Fill a clean vial (24 mm Ø) with **10 ml of the water sample**, close tightly with the cap.
2. Place the vial in the sample chamber making sure that the  $\Sigma$  marks are aligned.

prepare Zero  
press ZERO

3. Press **ZERO** key.
4. Remove the vial from the sample chamber.

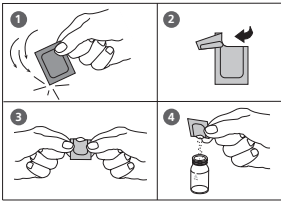

5. Add the contents of **one Chlorine TOTAL-DPD / F10 Powder Pack** straight from the foil to the water sample (note 5).
6. Close the vial tightly with the cap and swirl several times to mix the contents (approx. 20 seconds).
7. Place the vial in the sample chamber making sure that the  $\Sigma$  marks are aligned.

Zero accepted  
prepare Test  
press TEST

8. Press **TEST** key.  
Wait for a **reaction period of 3 minutes**.

Countdown  
3:00

After the reaction period is finished the measurement starts automatically.

The result is shown in the display in mg/l Bromine.

## 1.1 Methods

### Notes:

1. Vial cleaning:  
As many household cleaners (e.g. dishwasher detergent) contain reducing substances, the subsequent determination of Bromine may show lower results. To avoid any measurement errors, only use glassware free of Chlorine demand.  
Preparation: Put all applicable glassware into Sodium hypochlorite solution (0.1 g/l) for one hour, then rinse all glassware thoroughly with deionised water.
2. Preparing the sample:  
When preparing the sample, the loss of Bromine, e.g. by pipetting or shaking, must be avoided. The analysis must take place immediately after taking the sample.
3. The DPD colour development is carried out at a pH value of 6.2 to 6.5. The reagent tablet therefore contains a buffer for the pH adjustment. Strong alkaline or acidic water samples must be adjusted between pH 6 and pH 7 before the reagent is added (use 0.5 mol/l Sulfuric acid resp. 1 mol/l Sodium hydroxide).
4. Exceeding the measuring range:  
Concentrations above 4.5 mg/l Bromine can lead to results showing 0 mg/l.  
In this case, the water sample must be diluted with water free of Bromine.  
10 ml of the diluted sample should be mixed with the reagent and the measurement repeated.
5. Alternatively a Chlorine FREE-DPD / F10 powder pack may be used for the determination of some bromine compounds. Please follow the directions of the bromine compound manufacturer where necessary.
6. Oxidising agents such as Chlorine, Ozone etc. interfere as they react in the same way as Bromine.

Reagent / Accessories	Form of reagent/Quantity	Order-No.
Chlorine Total-DPD/F10	Powder Pack / 100	530120
Chlorine Free-DPD/F10	Powder Pack / 100	530100

## 1.1 Methods

9

0

### Chloride with Tablet

0.5 – 25 mg/l Cl



Ø 24 mm

prepare Zero  
press ZERO

1. Fill a clean vial (24 mm Ø) with **10 ml of the water sample**, close tightly with the cap.
2. Place the vial in the sample chamber making sure that the X marks are aligned.
3. Press **ZERO** key.

4. Remove the vial from the sample chamber.
5. Add **one CHLORIDE T1 tablet** straight from the foil to the water sample, crush the tablet using a clean stirring rod and dissolve the tablet.
6. Add **one CHLORIDE T2 tablet** straight from the foil to the same water sample and crush the tablet using a clean stirring rod.
7. Close the vial tightly with the cap and swirl gently several times until the tablet is dissolved (Note 1).
8. Place the vial in the sample chamber making sure that the X marks are aligned.

Zero accepted  
prepare Test  
press TEST

Countdown  
2:00

9. Press **TEST** key.

Wait for a **reaction period of 2 minutes**.

After the reaction period is finished the measurement starts automatically.

The result is shown in the display in mg/l Chloride.



## 1.1 Methods

### Notes:

1. Ensure that all particles of the tablet are dissolved – Chloride causes an extremely fine distributed turbidity with a milky appearance.  
**Heavy shaking leads to bigger sized particles which can cause false readings.**
2. High concentrations of electrolytes and organic compounds have different effects on the precipitation reaction.
3. Ions which also form deposits with Silver nitrate in acidic media, such as Bromides, Iodides and Thiocyanates, interfere with the analysis.
4. Highly alkaline water should - if necessary - be neutralised using Nitric acid before analysis.
5. Conversion:  
 $\text{mg/l NaCl} = \text{mg/l Cl}^- \times 1,65$
6. ▲ Cl<sup>-</sup>  
▼ NaCl

Reagent / Accessories	Form of reagent/Quantity	Order-No.
<b>Set</b> CHLORIDE T1 / T2	Tablet / per 100 inclusive stirring rod	517741BT
CHLORIDE T1	Tablet / 100	515910BT
CHLORIDE T2	Tablet / 100	515920BT

## 1.1 Methods

9

2

### Chloride with Liquid Reagent

0.5 – 20 mg/l Cl<sup>-</sup>



prepare Zero  
press ZERO

1. Fill a clean vial (24 mm Ø) with **10 ml of the water sample**, close tightly with the cap.
2. Place the vial in the sample chamber making sure that the X marks are aligned.
3. Press **ZERO** key.

4. Remove the vial from the sample chamber.
5. Fill the vial with drops of the same size by holding the bottle vertically and squeeze slowly:  
**20 drops KS251 (Chloride Reagent A)**

6. Close the vial tightly with the cap and invert several times to mix the contents.

7. Fill the vial with drops of the same size by holding the bottle vertically and squeeze slowly:  
**20 drops KS253 (Chloride Reagent B)**

8. Close the vial tightly with the cap and invert several times to mix the contents.

8. Place the vial in the sample chamber making sure that the X marks are aligned.

9. Press **TEST** key.  
Wait for a **reaction period of 5 minutes**.

Zero accepted  
prepare Test  
press TEST

Countdown  
5:00

After the reaction period is finished the measurement starts automatically.

The result is shown in the display in mg/l Chloride.

## 1.1 Methods

### Notes:

1. Chloride causes an extremely fine distributed turbidity with a milky appearance. **Heavy shaking leads to bigger sized particles which can cause false readings.**
2. Conversion:  
 $\text{mg/l NaCl} = \text{mg/l Cl}^- \times 1,65$
3. ▲ Cl<sup>-</sup>  
▼ NaCl

Reagent / Accessories	Form of reagent/Quantity	Order-No.
KS251 (Chloride Reagenz A)	Liquid reagent / 65 ml	56L025165
KS253 (Chloride Reagenz B)	Liquid reagent / 65 ml	56L025365

## 1.1 Methods

1 0 0

### Chlorine with Tablet

0.01 – 6 mg/l Cl<sub>2</sub>

1 0 3

### Chlorine HR with Tablet

0.1 – 10 mg/l Cl<sub>2</sub>

1 0 1

### Chlorine with Liquid Reagent

0.02 - 4 mg/l Cl<sub>2</sub>

1 1 0

### Chlorine with Powder Pack

0.02 - 2 mg/l Cl<sub>2</sub>

1 1 3

### Chlorine MR with Vario Powder Pack

0.02 - 3.5 mg/l Cl<sub>2</sub>

1 1 1

### Chlorine HR with Powder Pack

0.1 - 8 mg/l Cl<sub>2</sub>

Chlorine  
>> diff  
free  
total

The following selection is shown in the display:

>> diff

for the differentiated determination of free, combined and total Chlorine.

>> free

for the determination of free Chlorine.

>> total

for the determination of total Chlorine.

Select the desired determination with the arrow keys [▲] and [▼]. Confirm with [↵] key.

# 1.1 Methods

## Notes:

1. Vial cleaning:  
As many household cleaners (e.g. dishwasher detergent) contain reducing substances, the subsequent determination of Chlorine may show lower results. To avoid any measurement errors, only use glassware free of Chlorine demand.  
Preparation: Put all applicable glassware into Sodium hypochlorite solution (0.1 g/l) for one hour, then rinse all glassware thoroughly with deionised water.
2. For individual testing of free and total Chlorine, the use of different sets of glassware is recommended (EN ISO 7393-2, 5.3)
3. Preparing the sample:  
When preparing the sample, the lost of Chlorine, e.g. by pipetting or shaking, must be avoided. The analysis must take place immediately after taking the sample.
4. The DPD colour development is carried out at a pH value of 6.2 to 6.5. The reagents therefore contain a buffer for the pH adjustment.  
Strong alkaline or acidic water samples must be adjusted between pH 6 and pH 7 before the reagent is added (use 0.5 mol/l Sulfuric acid resp. 1 mol/l Sodium hydroxide).
5. Exceeding the measuring range:  
Concentrations above:  
10 mg/l Chlorine using tablets (method 100)  
4 mg/l Chlorine using liquid reagents (method 101)  
2 mg/l using powder packs (method 110)  
8 mg/l using powder packs (method 111)  
8 mg/l using powder packs (method 113)  
can lead to results showing 0 mg/l. In this case, the water sample must be diluted with water free of Chlorine. 10 ml of the diluted sample should be mixed with the reagent and the measurement repeated.
6. Turbidity (can lead to errors):  
The use of the reagent tablets in samples with high Calcium ion contents\* and/or high conductivity\* can lead to turbidity of the sample and therefore incorrect measurements. In this case, the reagent tablets DPD No. 1 High Calcium and DPD No. 3 High Calcium should be used as an alternative.  
*\* it is not possible to give exact values, because the development of turbidity depends on the nature of the sample.*
7. If [??] is displayed at a differentiated test result see page 356.
8. Oxidizing agents such as Bromine, Ozone etc. interfere as they react in the same way as Chlorine.

## 1.1 Methods

1 0 0

### Chlorine, free with Tablet

0.01 – 6 mg/l Cl<sub>2</sub>



1. Fill a clean vial (24 mm Ø) with **10 ml of the water sample**, close tightly with the cap.
2. Place the vial in the sample chamber making sure that the X marks are aligned.
3. Press **ZERO** key.
4. Remove the vial from the sample chamber and **empty it, leaving a few drops remaining in the vial**.
5. Add **one DPD No. 1 tablet** straight from the foil and crush the tablet using a clean stirring rod.
6. Add water sample to the 10 ml mark.
7. Close the vial tightly with the cap and swirl several times until the tablet is dissolved.
8. Place the vial in the sample chamber making sure that the X marks are aligned.

prepare Zero  
press ZERO

9. Press **TEST** key.

Zero accepted  
prepare Test  
press TEST

The result is shown in the display in mg/l free Chlorine.

#### Notes:

See page 45

## 1.1 Methods

1 0 0

### Chlorine, total with Tablet

0.01 – 6 mg/l Cl<sub>2</sub>



Ø 24 mm

prepare Zero  
press ZERO

1. Fill a clean vial (24 mm Ø) with **10 ml of the water sample**, close tightly with the cap.
2. Place the vial in the sample chamber making sure that the  $\Sigma$  marks are aligned.
3. Press **ZERO** key.
4. Remove the vial from the sample chamber and **empty it, leaving a few drops remaining in the vial.**
5. Add **one DPD No. 1 tablet** and **one DPD No. 3 tablet** straight from the foil and crush the tablets using a clean stirring rod.
6. Add water sample to the 10 ml mark.
7. Close the vial tightly with the cap and swirl several times until the tablets are dissolved.
8. Place the vial in the sample chamber making sure that the  $\Sigma$  marks are aligned.
9. Press **TEST** key.

Wait for a **reaction period of 2 minutes.**

After the reaction period is finished the measurement starts automatically.

The result is shown in the display in mg/l total Chlorine.

#### Notes:

See page 45

Zero accepted  
prepare Test  
press TEST

Countdown  
2:00

## 1.1 Methods

1 0 0

### Chlorine, differentiated determination with Tablet

0.01 – 6 mg/l Cl<sub>2</sub>



prepare Zero  
press ZERO

1. Fill a clean vial (24 mm Ø) with **10 ml of the water sample**, close tightly with the cap.
2. Place the vial in the sample chamber making sure that the X marks are aligned.
3. Press **ZERO** key.
4. Remove the vial from the sample chamber and **empty it, leaving a few drops remaining in the vial.**
5. Add **one DPD No. 1 tablet** straight from the foil and crush the tablet using a clean stirring rod.
6. Add water sample to the 10 ml mark.
7. Close the vial tightly with the cap and swirl several times until the tablet is dissolved.
8. Place the vial in the sample chamber making sure that the X marks are aligned.
9. Press **TEST** key.
10. Remove the vial from the sample chamber.
11. Add **one DPD No. 3 tablet** straight from the foil to the same water sample and crush the tablet using a clean stirring rod.
12. Close the vial tightly with the cap and swirl several times until the tablet is dissolved.

Zero accepted  
prepare T1  
press TEST



## 1.1 Methods

13. Place the vial in the sample chamber making sure that the  $\Sigma$  marks are aligned.

**T1 accepted  
prepare T2  
press TEST**

14. Press **TEST** key.  
Wait for a **reaction period of 2 minutes**.

**Countdown  
2:00**

After the reaction period is finished the measurement starts automatically.

**\*,\*\* mg/l free Cl  
\*,\*\* mg/l comb Cl  
\*,\*\* mg/l total Cl**

The result is shown in the display in:

mg/l free Chlorine  
mg/l combined Chlorine  
mg/l total Chlorine

### Notes:

See page 45

Reagent / Accessories	Form of reagent/Quantity	Order-No.
<b>Set</b> DPD No. 1 / No. 3	Tablet / per 100 inclusive stirring rod	517711BT
DPD No. 1	Tablet / 100	511050BT
DPD No. 3	Tablet / 100	511080BT
<b>Set</b> DPD No. 1 HIGH CALCIUM/ DPD No. 3 HIGH CALCIUM	Tablet / per 100 inclusive stirring rod	517781BT
DPD No. 1 HIGH CALCIUM	Tablet / 100	515740BT
DPD No. 3 HIGH CALCIUM	Tablet / 100	515730BT

## 1.1 Methods

1 0 3

### Chlorine HR, free with Tablet

0.1 – 10 mg/l Cl<sub>2</sub>



prepare Zero  
press ZERO

1. Fill a clean vial (24 mm Ø) with **10 ml of the water sample**, close tightly with the cap.
2. Place the vial in the sample chamber making sure that the X marks are aligned.
3. Press **ZERO** key.
4. Remove the vial from the sample chamber and **empty it, leaving a few drops remaining in the vial.**
5. Add **one DPD No. 1 HR tablet** straight from the foil and crush the tablet using a clean stirring rod.
6. Add water sample to the 10 ml mark.
7. Close the vial tightly with the cap and swirl several times until the tablet is dissolved.
8. Place the vial in the sample chamber making sure that the X marks are aligned.

Zero accepted  
prepare Test  
press TEST

9. Press **TEST** key.

The result is shown in the display in mg/l free Chlorine.

#### Notes:

See page 45

## 1.1 Methods

1 0 3

### Chlorine HR, total with Tablet

0.1 – 10 mg/l Cl<sub>2</sub>



prepare Zero  
press ZERO

1. Fill a clean vial (24 mm Ø) with **10 ml of the water sample**, close tightly with the cap.
2. Place the vial in the sample chamber making sure that the  $\times$  marks are aligned.
3. Press **ZERO** key.
4. Remove the vial from the sample chamber and **empty it, leaving a few drops remaining in the vial.**
5. Add **one DPD No. 1 HR tablet** and **one DPD No. 3 HR tablet** straight from the foil and crush the tablets using a clean stirring rod.
6. Add water sample to the 10 ml mark.
7. Close the vial tightly with the cap and swirl several times until the tablets are dissolved.
8. Place the vial in the sample chamber making sure that the  $\times$  marks are aligned.
9. Press **TEST** key.  
Wait for a **reaction period of 2 minutes.**

Zero accepted  
prepare Test  
press TEST

Countdown  
2:00

After the reaction period is finished the measurement starts automatically.

The result is shown in the display in mg/l total Chlorine.

#### Notes:

See page 45

## 1.1 Methods

1 0 3

### Chlorine HR, differentiated determination with Tablet

0.1 – 10 mg/l Cl<sub>2</sub>



Ø 24 mm

prepare Zero  
press ZERO

1. Fill a clean vial (24 mm Ø) with **10 ml of the water sample**, close tightly with the cap.
2. Place the vial in the sample chamber making sure that the  $\Sigma$  marks are aligned.
3. Press **ZERO** key.

4. Remove the vial from the sample chamber and **empty it, leaving a few drops remaining in the vial.**
5. Add **one DPD No. 1 HR tablet** straight from the foil and crush the tablet using a clean stirring rod.
6. Add water sample to the 10 ml mark.
7. Close the vial tightly with the cap and swirl several times until the tablet is dissolved.

Zero accepted  
prepare T1  
press TEST

8. Place the vial in the sample chamber making sure that the  $\Sigma$  marks are aligned.
9. Press **TEST** key.
10. Remove the vial from the sample chamber.
11. Add **one DPD No. 3 HR tablet** straight from the foil to the same water sample and crush the tablet using a clean stirring rod.

## 1.1 Methods

12. Close the vial tightly with the cap and swirl several times until the tablet is dissolved.
13. Place the vial in the sample chamber making sure that the  $\Sigma$  marks are aligned.
14. Press **TEST** key.  
Wait for a **reaction period of 2 minutes**.

T1 accepted  
prepare T2  
press TEST

Countdown  
2:00

After the reaction period is finished the measurement starts automatically.

The result is shown in the display in:

\*,\*\* mg/l free Cl  
\*,\*\* mg/l comb Cl  
\*,\*\* mg/l total Cl

mg/l free Chlorine  
mg/l combined Chlorine  
mg/l total Chlorine

### Notes:

See page 45

Reagent / Accessories	Form of reagent/Quantity	Order-No.
DPD No. 1 HR	Tablet / 100	511500BT
DPD No. 3 HR	Tablet / 100	511590BT

## 1.1 Methods

1 0 1

### Chlorine, free with Liquid Reagent

0.02 – 4 mg/l Cl<sub>2</sub>



prepare Zero  
press ZERO

1. Fill a clean vial (24 mm Ø) with **10 ml of the water sample**, close tightly with the cap.
2. Place the vial in the sample chamber making sure that the X marks are aligned.
3. Press **ZERO** key.

4. Remove the vial from the sample chamber and **empty the vial**.

5. Fill the vial with drops of the same size by holding the bottle vertically and squeeze slowly:

**6 drops of DPD 1 buffer solution**

**2 drops of DPD 1 reagent solution**

6. Add water sample to the 10 ml mark.
7. Close the vial tightly with the cap and swirl several times to mix the contents.
8. Place the vial in the sample chamber making sure that the X marks are aligned.
9. Press **TEST** key.

Zero accepted  
prepare Test  
press TEST

The result is shown in the display in mg/l free Chlorine.

#### Notes (free and total Chlorine):

1. Also see page 45 and 57

## 1.1 Methods

1 0 1

### Chlorine, total with Liquid Reagent

0.02 – 4 mg/l Cl<sub>2</sub>



Ø 24 mm

prepare Zero  
press ZERO

1. Fill a clean vial (24 mm Ø) with **10 ml of the water sample**, close tightly with the cap.
2. Place the vial in the sample chamber making sure that the  $\Sigma$  marks are aligned.
3. Press **ZERO** key.
4. Remove the vial from the sample chamber and **empty the vial**.
5. Fill the vial with drops of the same size by holding the bottle vertically and squeeze slowly:  
**6 drops of DPD 1 buffer solution**  
**2 drops of DPD 1 reagent solution**  
**3 drops of DPD 3 solution**
6. Add water sample to the 10 ml mark.
7. Close the vial tightly with the cap and swirl several times to mix the contents.
8. Place the vial in the sample chamber making sure that the  $\Sigma$  marks are aligned.
9. Press **TEST** key.  
Wait for a **reaction period of 2 minutes**.

Zero accepted  
prepare Test  
press TEST

Countdown  
2:00

After the reaction period is finished the measurement starts automatically.

The result is shown in the display in mg/l total Chlorine.

## 1.1 Methods

1 0 1

### Chlorine, differentiated determination with Liquid Reagent

0.02 – 4 mg/l Cl<sub>2</sub>



Ø 24 mm

prepare Zero  
press ZERO

1. Fill a clean vial (24 mm Ø) with **10 ml of the water sample**, close tightly with the cap.

2. Place the vial in the sample chamber making sure that the  $\Sigma$  marks are aligned.

3. Press **ZERO** key.

4. Remove the vial from the sample chamber and **empty the vial**.

5. Fill the vial with drops of the same size by holding the bottle vertically and squeeze slowly:

**6 drops of DPD 1 buffer solution**

**2 drops of DPD 1 reagent solution**

6. Add water sample to the 10 ml mark.

7. Close the vial tightly with the cap and swirl several times to mix the contents.

8. Place the vial in the sample chamber making sure that the  $\Sigma$  marks are aligned.

9. Press **TEST** key.

10. Remove the vial from the sample chamber.

11. **Add 3 drops of DPD 3 solution** to the same water sample.

12. Close the vial tightly with the cap and swirl several times to mix the contents.

Zero accepted  
prepare T1  
press TEST



## 1.1 Methods

**T1 accepted  
prepare T2  
press TEST**

**Countdown  
2:00**

13. Place the vial in the sample chamber making sure that the  $\times$  marks are aligned.

14. Press **TEST** key.  
Wait for a **reaction period of 2 minutes**.

After the reaction period is finished the measurement starts automatically.

The result is shown in the display in:

**\*,\*\* mg/l free Cl**  
**\*,\*\* mg/l comb. Cl**  
**\*,\*\* mg/l total Cl**

mg/l free Chlorine  
mg/l combined Chlorine  
mg/l total Chlorine

### Notes:

1. After use replace the bottle caps securely noting the colour coding.

**2. Store the reagent bottles in a cool, dry place ideally between 6°C and 10°C.**

3. Also see page 45

4. In samples with high Calcium ion contents\* and/or high conductivity\* can lead to turbidity of the sample and therefore incorrect measurements. In this case, the reagent tablets DPD No. 1 High Calcium and DPD No. 3 High Calcium should be used as an alternative. (Order-No.: see reagents „Chlorine with Tablet“).

*\* it is not possible to give exact values, because the development of turbidity depends on the nature of the sample.*

Reagent / Accessories	Form of reagent/Quantity	Order-No.
<b>Set</b> DPD No. 1 buffer solution DPD No. 1 reagent solution DPD No. 3 solution	(approx. 300 tests) 3 x Liquid reagent / 15 ml 1 x Liquid reagent / 15 ml 2 x Liquid reagent / 15 ml	471056
DPD No. 1 buffer solution	Liquid reagent / 15 ml	471010
DPD No. 1 reagent solution	Liquid reagent / 15 ml	471020
DPD No. 3 solution	Liquid reagent / 15 ml	471030

## 1.1 Methods

1 1 0

### Chlorine, free with Powder Pack

0.02 – 2 mg/l Cl<sub>2</sub>



prepare Zero  
press ZERO

1. Fill a clean vial (24 mm Ø) with **10 ml of the water sample**, close tightly with the cap.
2. Place the vial in the sample chamber making sure that the X marks are aligned.
3. Press **ZERO** key.
4. Remove the vial from the sample chamber.

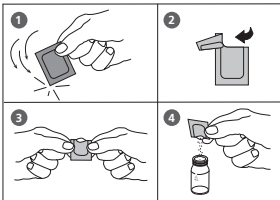

5. Add the contents of **one Chlorine FREE-DPD / F10 Powder Pack** straight from the foil to the water sample.
6. Close the vial tightly with the cap and swirl several times to mix the contents (approx. 20 seconds).
7. Place the vial in the sample chamber making sure that the X marks are aligned.

Zero accepted  
prepare Test  
press TEST

8. Press **TEST** key.

The result is shown in the display in mg/l free Chlorine.

#### Notes:

See page 45

## 1.1 Methods

1 1 0

### Chlorine, total with Powder Pack

0.02 – 2 mg/l Cl<sub>2</sub>



prepare Zero  
press ZERO

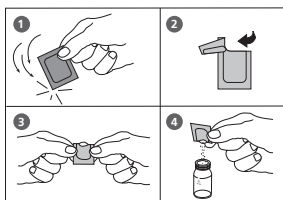

Zero accepted  
prepare Test  
press TEST

Countdown  
3:00

1. Fill a clean vial (24 mm Ø) with **10 ml of the water sample**, close tightly with the cap.
2. Place the vial in the sample chamber making sure that the X marks are aligned.
3. Press **ZERO** key.
4. Remove the vial from the sample chamber.
5. Add the contents of **one Chlorine TOTAL-DPD / F10 Powder Pack** straight from the foil to the water sample.
6. Close the vial tightly with the cap and swirl several times to mix the contents (approx. 20 seconds).
7. Place the vial in the sample chamber making sure that the X marks are aligned.
8. Press **TEST** key.  
Wait for a **reaction period of 3 minutes**.

After the reaction period is finished the measurement starts automatically.

The result is shown in the display in mg/l total Chlorine.

#### Notes:

See page 45

## 1.1 Methods

1 1 0

### Chlorine, differentiated determination with Powder Pack

0.02 – 2 mg/l Cl<sub>2</sub>



prepare Zero  
press ZERO

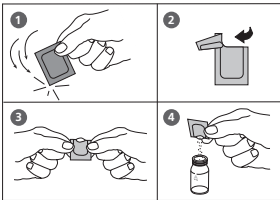

Zero accepted  
prepare T1  
press TEST

1. Fill a clean vial (24 mm Ø) with **10 ml of the water sample**, close tightly with the cap.
2. Place the vial in the sample chamber making sure that the X marks are aligned.
3. Press **ZERO** key.
4. Remove the vial from the sample chamber.
5. Add the contents of **one Chlorine FREE-DPD/F10 Powder Pack** straight from the foil to the water sample.
6. Close the vial tightly with the cap and swirl several times to mix the contents (approx. 20 seconds).
7. Place the vial in the sample chamber making sure that the X marks are aligned.
8. Press **TEST** key.
9. Remove the vial from the sample chamber, empty the vial, rinse vial and cap several times and then fill the vial with **10 ml of the water sample**.
10. Add the contents of **one Chlorine TOTAL-DPD / F10 Powder Pack** straight from the foil to the water sample.
11. Close the vial tightly with the cap and swirl several times to mix the contents (approx. 20 seconds).

## 1.1 Methods

T1 accepted  
prepare T2  
press TEST

Countdown  
3:00

\*,\*\* mg/l free Cl  
\*,\*\* mg/l comb. Cl  
\*,\*\* mg/l total Cl

12. Place the vial in the sample chamber making sure that the  $\Sigma$  marks are aligned.

13. Press **TEST** key.  
Wait for a **reaction period of 3 minutes**.

After the reaction period is finished the measurement starts automatically.

The result is shown in the display in:

mg/l free Chlorine  
mg/l combined Chlorine  
mg/l total Chlorine

### Notes:

See page 45

Reagent / Accessories	Form of reagent/Quantity	Order-No.
Chlorine Free-DPD/F10	Powder Pack / 100	530100
Chlorine Total-DPD/F10	Powder Pack / 100	530120

## 1.1 Methods



### Chlorine MR, free with Powder Pack

0.02 – 3.5 mg/l Cl<sub>2</sub>



Ø 24 mm

1. Fill a clean vial (24 mm Ø) with **10 ml of the water sample**, close tightly with the cap.
2. Place the vial in the sample chamber making sure that the X marks are aligned.
3. Press **ZERO** key.

prepare Zero  
press ZERO

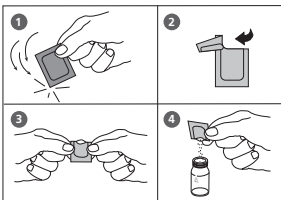

4. Remove the vial from the sample chamber.
5. Add the contents of **one VARIO Chlorine FREE-DPD / F10 Powder Pack (blue color marking **) straight from the foil to the water sample.
6. Close the vial tightly with the cap and swirl several times to mix the contents (approx. 20 seconds).
7. Place the vial in the sample chamber making sure that the X marks are aligned.

Zero accepted  
prepare Test  
press TEST

8. Press **TEST** key.

The result is shown in the display in mg/l free Chlorine.

#### Notes:

See page 45

## 1.1 Methods

1 1 3

### Chlorine MR, total with Powder Pack

0.02 – 3.5 mg/l Cl<sub>2</sub>



1. Fill a clean vial (24 mm Ø) with **10 ml of the water sample**, close tightly with the cap.
2. Place the vial in the sample chamber making sure that the X marks are aligned.

prepare Zero  
press ZERO

3. Press **ZERO** key.

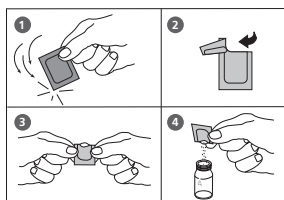

4. Remove the vial from the sample chamber.
5. Add the contents of **one VARIO Chlorine TOTAL-DPD / F10 Powder Pack (blue color marking )** straight from the foil to the water sample.
6. Close the vial tightly with the cap and swirl several times to mix the contents (approx. 20 seconds).
7. Place the vial in the sample chamber making sure that the X marks are aligned.

Zero accepted  
prepare Test  
press TEST

8. Press **TEST** key.  
Wait for a **reaction period of 3 minutes**.

Countdown  
3:00

After the reaction period is finished the measurement starts automatically.

The result is shown in the display in mg/l total Chlorine.

#### Notes:

See page 45

## 1.1 Methods

1 1 3

### Chlorine MR, differentiated determination with Powder Pack



0.02 – 3.5 mg/l Cl<sub>2</sub>

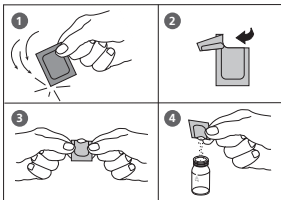

prepare Zero  
press ZERO



Zero accepted  
prepare T1  
press TEST

1. Fill a clean vial (24 mm Ø) with **10 ml of the water sample**, close tightly with the cap.
2. Place the vial in the sample chamber making sure that the X marks are aligned.
3. Press **ZERO** key.
4. Remove the vial from the sample chamber.
5. Add the contents of **one VARIO Chlorine FREE-DPD/ F10 Powder Pack (blue color marking )** straight from the foil to the water sample.
6. Close the vial tightly with the cap and swirl several times to mix the contents (approx. 20 seconds).
7. Place the vial in the sample chamber making sure that the X marks are aligned.
8. Press **TEST** key.
9. Remove the vial from the sample chamber, empty the vial, rinse vial and cap several times and then fill the vial with **10 ml of the water sample**.
10. Add the contents of **one VARIO Chlorine TOTAL-DPD / F10 Powder Pack (blue color marking )** straight from the foil to the water sample.
11. Close the vial tightly with the cap and swirl several times to mix the contents (approx. 20 seconds).



# 1.1 Methods

T1 accepted  
prepare T2  
press TEST

Countdown  
3:00

\*,\*\* mg/l free Cl  
\*,\*\* mg/l comb. Cl  
\*,\*\* mg/l total Cl

12. Place the vial in the sample chamber making sure that the X marks are aligned.

13. Press **TEST** key.  
Wait for a **reaction period of 3 minutes**.



After the reaction period is finished the measurement starts automatically.

The result is shown in the display in:

mg/l free Chlorine  
mg/l combined Chlorine  
mg/l total Chlorine

**Notes:**

See page 45

Reagent / Accessories		Form of reagent/Quantity	Order-No.
VARIO Chlorine Free-DPD/F10 (blue color marking)		Powder Pack / 100	530180
VARIO Chlorine Total-DPD/F10 (blue color marking)		Powder Pack / 100	530190

## 1.1 Methods



### Chlorine HR, free with Powder Pack plastic vial (type 3) ∩ 10 mm

0.1 – 8 mg/l Cl<sub>2</sub>

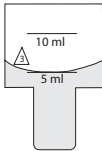

1. Fill a clean vial (10 mm Ø) with **5 ml of the water sample**, close tightly with the cap.
2. Place the vial in the sample chamber making sure that the  $\nabla$  marks are aligned.

prepare Zero  
press ZERO

3. Press **ZERO** key.
4. Remove the vial from the sample chamber.

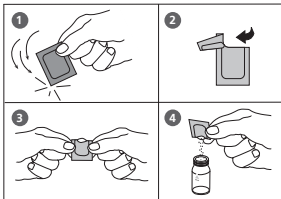

5. Add the contents of **two Chlorine Free-DPD/F10 Powder Pack** straight from the foil into the water sample.
6. Close the vial tightly with the cap and invert several times to mix the contents (20 sec.).
7. Place the vial in the sample chamber making sure that the  $\nabla$  marks are aligned.

Zero accepted  
prepare Test  
press TEST

8. Press the **TEST** key.

The result is shown in the display in mg/l free Chlorine.

#### Notes:

See page 45

## 1.1 Methods

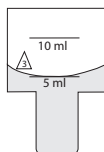

### Chlorine HR, total with Powder Pack plastic vial (type 3) $\sqcup$ 10 mm

0.1 – 8 mg/l  $\text{Cl}_2$

1. Fill a clean vial (10 mm  $\varnothing$ ) with **5 ml of the water sample**, close tightly with the cap.
2. Place the vial in the sample chamber making sure that the  $\times$  marks are aligned.

prepare Zero  
press ZERO

3. Press **ZERO** key.

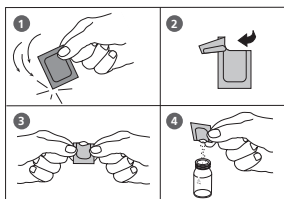

4. Remove the vial from the sample chamber.
5. Add the contents of **two Chlorine Free-DPD/F10 Powder Pack** straight from the foil into the water sample.
6. Close the vial tightly with the cap and swirl several times to mix the contents (approx. 20 seconds).
7. Place the vial in the sample chamber making sure that the  $\times$  marks are aligned.

Zero accepted  
prepare Test  
press TEST

8. Press **TEST** key.  
Wait for a **reaction period of 3-6 minutes**.

Countdown  
3:00

After the reaction period is finished the measurement starts automatically.

The result is shown in the display in mg/l total Chlorine.

**Notes:**  
See page 45

## 1.1 Methods

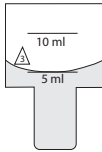

### Chlorine HR, differentiated determination with Powder Pack plastic vial (type 3) $\varnothing$ 10 mm

0.1 – 8 mg/l  $\text{Cl}_2$

1. Fill a clean vial (10 mm  $\varnothing$ ) with **5 ml of the water sample**, close tightly with the cap.
2. Place the vial in the sample chamber making sure that the  $\nabla$  marks are aligned.

**prepare Zero  
press ZERO**

3. Press **ZERO** key.

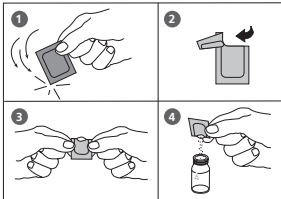

4. Remove the vial from the sample chamber.
5. Add the contents of **two Chlorine Free-DPD/F10 Powder Pack** straight from the foil into the water sample.
6. Close the vial tightly with the cap and invert several times to mix the contents (20 sec.).
7. Place the vial in the sample chamber making sure that the  $\nabla$  marks are aligned.

**Zero accepted  
prepare T1  
press TEST**

8. Press the **TEST** key.
9. Remove the vial from the sample chamber, empty the vial, rinse vial and cap several times and then fill the vial with 5 ml of the water sample.
10. Add the contents of **two Chlorine TOTAL-DPD/F10 Powder Pack** straight from the foil into the water sample.

## 1.1 Methods

11. Close the vial tightly with the cap and invert several times to mix the contents (20 sec.).
12. Place the vial in the sample chamber making sure that the  $\bar{X}$  marks are aligned.
13. Press **TEST** key.

T1 accepted  
prepare T2  
press TEST

Countdown  
3:00

**Wait for a reaction period of 3 minutes.**

After the reaction period is finished the measurement starts automatically.

The result is shown in the display in:

\*,\*\* mg/l free Cl  
\*,\*\* mg/l comb. Cl  
\*,\*\* mg/l total Cl

mg/l free Chlorine  
mg/l combined Chlorine  
mg/l total Chlorine

### Notes:

See page 45

Reagent / Accessories	Form of reagent/Quantity	Order-No.
Chlorine Free-DPD/F10	Powder Pack / 100	530100
Chlorine Total-DPD/F10	Powder Pack / 100	530120

## 1.1 Methods

1

2

0

### Chlorine dioxide with Tablet

0.02 – 11 mg/l ClO<sub>2</sub>

#### Chlorine dioxide

>> with Cl  
without Cl

The following selection is shown in the display:

>> with Cl

for the determination of Chlorine dioxide in the presence of Chlorine.

>> without Cl

for the determination of Chlorine dioxide in the absence of Chlorine.

Select the desired determination with the arrow keys [▲] and [▼]. Confirm with [↵] key.

## 1.1 Methods

### Notes:

1. Vial cleaning:  
As many household cleaners (e.g. dishwasher detergent) contain reducing substances, the subsequent determination of Chlorine dioxide may show lower results. To avoid any measurement errors, only use glassware free of Chlorine demand.  
Preparation: Put all applicable glassware into Sodium hypochlorite solution (0.1 g/l) for one hour, then rinse all glassware thoroughly with deionised water.
2. Preparing the sample:  
When preparing the sample, the loss of Chlorine dioxide, e.g. by pipetting or shaking, must be avoided. The analysis must take place immediately after taking the sample.
3. The DPD colour development is carried out at a pH value of 6.2 to 6.5. The reagent tablet therefore contains a buffer for the pH adjustment.  
Strong alkaline or acidic water samples must be adjusted between pH 6 and pH 7 before the tablet is added (use 0.5 mol/l Sulfuric acid resp. 1 mol/l Sodium hydroxide).
4. Exceeding the measuring range:  
Concentrations above 19 mg/l Chlorine dioxide can lead to results showing 0 mg/l. In this case, the water sample must be diluted with water free of Chlorine dioxide. 10 ml of the diluted sample should be mixed with the reagent and the measurement repeated.
5. If ??? is displayed at a differentiated test result see page 356.
6. Oxidising agents such as Chlorine, Ozone etc. interfere as they react in the same way as Chlorine dioxide.

Reagent / Accessories	Form of reagent/Quantity	Order-No.
DPD No. 1	Tablet / 100	511050BT
GLYCINE	Tablet / 100	512170BT

## 1.1 Methods



### Chlorine dioxide in the presence of Chlorine with Tablet

0.02 – 11 mg/l ClO<sub>2</sub>



1. Fill a clean vial (24 mm Ø) with **10 ml of the water sample**.
2. Add **one GLYCINE tablet** straight from the foil and crush the tablet using a clean stirring rod.
3. Close the vial tightly with the cap and swirl several times until the tablet is dissolved.
4. **Fill a second clean vial with 10 ml of water sample** and close tightly with the cap.
5. Place the vial in the sample chamber making sure that the  $\Sigma$  marks are aligned.
6. Press **ZERO** key.
7. Remove the vial from the sample chamber and **empty the vial**.
8. Add **one DPD No. 1 tablet** straight from the foil and crush the tablet using a clean stirring rod.
9. **Transfer the contents of the first vial (Glycine solution) into the prepared vial (point 8)**.
10. Close the vial tightly with the cap and swirl several times until the tablet is dissolved.
11. Place the vial in the sample chamber making sure that the  $\Sigma$  marks are aligned.
12. Press **TEST** key.

prepare Zero  
press ZERO

Zero accepted  
prepare T1  
press TEST



## 1.1 Methods

**T1 accepted  
prepare T2  
press TEST**

13. Remove the vial from the sample chamber, empty the vial, rinse vial and cap several times. Fill with **a few drops of water sample**.
14. Add **one DPD No. 1 tablet** straight from the foil and crush the tablet using a clean stirring rod.
15. Add water sample to the 10 ml mark.
16. Close the vial tightly with the cap and swirl several times until the tablet is dissolved.
17. Place the vial in the sample chamber making sure that the  $\times$  marks are aligned.
18. Press **TEST** key.
19. Remove the vial from the sample chamber.
20. Add **one DPD No. 3 tablet** straight from the foil to the same water sample and crush the tablet using a clean stirring rod.
21. Close the vial tightly with the cap and swirl several times until the tablet is dissolved.
22. Place the vial in the sample chamber making sure that the  $\times$  marks are aligned.
23. Press **TEST** key.  
Wait for a **reaction period of 2 minutes**.

**T2 accepted  
prepare T3  
press TEST**

**Countdown  
2:00**

After the reaction period is finished the measurement starts automatically.

The result is shown in the display in:

**\*,\*\* mg/l ClO<sub>2</sub>**

Chlorine dioxide in mg/l ClO<sub>2</sub>.

**\*,\*\* mg/l free Cl  
\*,\*\* mg/l comb. Cl  
\*,\*\* mg/l total Cl**

mg/l free Chlorine  
mg/l combined Chlorine  
mg/l total Chlorine

### Notes:

See next page.

## 1.1 Methods

### Notes: (Chlorine dioxide in the presence of Chlorine)

1. The conversion factor to convert Chlorine dioxide (display) to Chlorine dioxide as Chlorine is 2.6315.  
 $\text{mg/l ClO}_2 [\text{Cl}] = \text{mg/l ClO}_2 \cdot 2,6315$   
Chlorine dioxide displayed as Chlorine units  $\text{ClO}_2 [\text{Cl}]$  has its origin in swimming poolwater treatment according to DIN 19643.
2. The total Chlorine result given includes the contribution of the chlorine dioxide as Chlorine reading. For true Chlorine value add the free and combined Chlorine readings.
3. See also page 71.

Reagent / Accessories	Form of reagent/Quantity	Order-No.
DPD No. 1	Tablet / 100	511050BT
DPD No. 3	Tablet / 100	511080BT
GLYCINE	Tablet / 100	512170BT

## 1.1 Methods



### Chlorine dioxide in absence of Chlorine with Tablet

0.02 – 11 mg/l ClO<sub>2</sub>



1. Fill a clean vial (24 mm Ø) with **10 ml of the water sample**, close tightly with the cap.
2. Place the vial in the sample chamber making sure that the  $\times$  marks are aligned.

**prepare Zero  
press ZERO**

3. Press **ZERO** key.
4. Remove the vial from the sample chamber and **empty it, leaving a few drops remaining in the vial.**
5. Add **one DPD No. 1 tablet** straight from the foil and crush the tablet using a clean stirring rod.
6. Add water sample to the 10 ml mark.
7. Close the vial tightly with the cap and swirl several times until the tablet is dissolved.
8. Place the vial in the sample chamber making sure that the  $\times$  marks are aligned.

**Zero accepted  
prepare Test  
press TEST**

9. Press **TEST** key.

**\*,\*\* mg/l ClO<sub>2</sub>**

The result is shown in the display as Chlorine dioxide in mg/l ClO<sub>2</sub>.

#### Notes:

See page 71

## 1.1 Methods

1 2 2

### Chlorine dioxide in absence of Chlorine with Powder Pack

0.04 – 3.8 mg/l ClO<sub>2</sub>



1. Fill a clean vial (24 mm Ø) with **10 ml of the water sample**, close tightly with the cap.
2. Place the vial in the sample chamber making sure that the  $\Sigma$  marks are aligned.

prepare Zero  
press ZERO

3. Press **ZERO** key.
4. Remove the vial from the sample chamber.

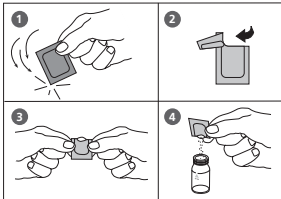

5. Add the contents of **one Chlorine FREE-DPD / F10 Powder Pack** straight from the foil to the water sample (Note 5).
6. Close the vial tightly with the cap and swirl several times to mix the contents (approx. 20 seconds).
7. Place the vial in the sample chamber making sure that the  $\Sigma$  marks are aligned.

Zero accepted  
prepare Test  
press TEST

8. Press **TEST** key.

The result is shown in the display in mg/l Chlorine dioxide.

#### Notes:

See page 78

## 1.1 Methods



### Chlorine dioxide in the presence of Chlorine with Powder Pack

0.04 – 3.8 mg/l ClO<sub>2</sub>



prepare Zero  
press ZERO

1. Fill a clean vial (24 mm Ø) with **10 ml of the water sample**, close tightly with the cap.
2. Place the vial in the sample chamber making sure that the  $\times$  marks are aligned.
3. Press **ZERO** key.

4. Remove the vial from the sample chamber.
5. Add **one GLYCINE tablet** straight from the foil to the water sample and crush the tablet using a clean stirring rod.
6. Close the vial tightly with the cap and swirl gently several times until the tablet is dissolved

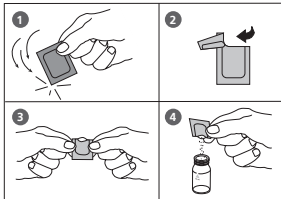

7. Add the contents of **one Chlorine FREE-DPD / F10 Powder Pack** straight from the foil into the prepared vial.
8. Close the vial tightly with the cap and swirl several times to mix the contents (approx. 20 seconds).
9. Place the vial in the sample chamber making sure that the  $\times$  marks are aligned.

Zero accepted  
prepare Test  
press TEST

10. Press **TEST** key.

The result is shown in the display in mg/l Chlorine dioxide.

#### Notes:

See page 78

## 1.1 Methods

### Notes:

1. Vial cleaning:

As many household cleaners (e.g. dishwasher detergent) contain reducing substances, the subsequent determination of Chlorine dioxide may show lower results. To avoid any measurement errors, only use glassware free of Chlorine demand.

Preparation: Put all applicable glassware into Sodium hypochlorite solution (0.1 g/l) for one hour, then rinse all glassware thoroughly with deionised water.

2. Preparing the sample:

When preparing the sample, the loss of Chlorine dioxide, e.g. by pipetting or shaking, must be avoided. The analysis must take place immediately after taking the sample.

3. The DPD colour development is carried out at a pH value of 6.2 to 6.5. The reagent tablet therefore contains a buffer for the pH adjustment.

Strong alkaline or acidic water samples must be adjusted between pH 6 and pH 7 before the tablet is added (use 0.5 mol/l Sulfuric acid resp. 1 mol/l Sodium hydroxide).

4. Exceeding the measuring range:

Concentrations above 3.8 mg/l Chlorine dioxide can lead to results showing 0 mg/l. In this case, the water sample must be diluted with water free of Chlorine dioxide.

10 ml of the diluted sample should be mixed with the reagent and the measurement repeated.

5. Oxidising agents such as Chlorine, Ozone etc. interfere as they react in the same way as Chlorine dioxide.

Reagent / Accessories	Form of reagent/Quantity	Order-No.
Chlorine Free-DPD/F10	Powder Pack / 100	530100
GLYCINE	Tablet / 100	512170BT



## 1.1 Methods



1 0 5

### Chlorine HR (KI) with Tablet

5 – 200 mg/l Cl<sub>2</sub>



Insert the adapter for 16 mm Ø vials.

1. Fill a clean vial (16 mm Ø) with **8 ml of the water sample**, close tightly with the cap.
2. Place the vial in the sample chamber making sure that the marks are  aligned.
3. Press **ZERO** key.
4. Remove the vial from the sample chamber.
5. Add **one CHLORINE HR (KI) tablet** straight from the foil to the water sample and crush the tablet using a clean stirring rod.
6. Add **one ACIDIFYING GP tablet** straight from the foil to the same water sample and crush the tablet using a clean stirring rod.
7. Close the vial tightly with the cap and swirl several times until the tablets are dissolved.
8. Place the vial in the sample chamber making sure that the marks are  aligned.
9. Press **TEST** key.

prepare Zero  
press ZERO

Zero accepted  
prepare Test  
press TEST

The result is shown in the display in mg/l Chlorine.



## 1.1 Methods

### Notes:

1. Oxidizing agents interfere as they react in the same way as Chlorine.

Reagent / Accessories	Form of reagent/Quantity	Order-No.
<b>Set:</b> ACIDIFYING GP/ CHLORINE HR (KI)	Tablet / per 100 inclusive stirring rod	517721BT
CHLORINE HR (KI)	Tablet / 100	513000BT
ACIDIFYING GP	Tablet / 100	515480BT

## 1.1 Methods

1 0 0

### Chlorite in presence of Chlorine and Chlorine dioxide

0,01 – 6 mg/l Cl<sub>2</sub>

Firstly, the glycine method is used to measure the concentration of Chlorine Dioxide. This is then followed by the determination of the free and total chlorine, from which the Combined Chlorine can be calculated. A third test is performed which measures the Total Chlorine concentration plus any Chlorite present. Finally, the Chlorite concentration can be calculated from the three recorded results.

Chlorine

>> diff  
free  
total

>> free

The following selection is shown in the display:

select for the determination of free Chlorine.



1. Fill a clean vial with **10 ml of water sample**.
2. Add **one GLYCINE tablet** straight from the foil to the water sample and crush the tablet using a clean stirring rod.
3. Close the vial tightly with the cap and swirl gently several times until the tablet is dissolved.
4. **Fill a second clean vial with 10 ml of water sample**, close tightly with the cap.
5. Place the vial in the sample chamber making sure that the  $\Sigma$  marks are aligned.
6. Press **ZERO** key.
7. **Remove the vial from the sample chamber and empty the vial.**
8. Add **one DPD No. 1 tablet** straight from the foil and crush the tablet using a clean stirring rod.

prepare Zero  
press ZERO

## 1.1 Methods

Zero accepted  
prepare Test  
press TEST

9. **Transfer the contents of the first vial (Glycine solution) into the prepared vial (point 8).**
10. Close the vial tightly with the cap and swirl several times until the tablets are dissolved.
11. Place the vial in the sample chamber making sure that the X marks are aligned.

12. Press **TEST** key.

**Record the displayed test result (G).**

13. Remove the vial from the sample chamber, empty the vial, rinse vial and cap several times. Fill with **a few drops of water sample**.
14. Add **one DPD No. 1 tablet** straight from the foil and crush the tablet using a clean stirring rod.
15. Add water sample to the 10 ml mark.
16. Close the vial tightly with the cap and swirl several times until the tablet is dissolved.
17. Place the vial in the sample chamber making sure that the X marks are aligned.

Zero accepted  
prepare Test  
press TEST

18. Press **TEST** key.

**Record the displayed test result (A).**

19. Remove the vial from the sample chamber.
20. Add **one DPD No. 3 tablet** straight from the foil to the same water sample and crush the tablet using a clean stirring rod.

## 1.1 Methods

21. Close the vial tightly with the cap and swirl several times until the tablet is dissolved.
22. Place the vial in the sample chamber making sure that the X marks are aligned.
23. Wait for a **reaction period of 2 minutes**.

Zero accepted  
prepare Test  
press TEST

24. Press **TEST** key.

**Record the displayed test result (C).**

25. Remove the vial from the sample chamber.
26. Add **one DPD ACIDIFYING tablet** straight from the foil to the same water sample and crush the tablet using a clean stirring rod.
27. Wait for a **reaction period of 2 minutes**.
28. Add **one DPD NEUTRALISING tablet** straight from the foil to the same water sample and crush the tablet using a clean stirring rod.
29. Close the vial tightly with the cap and swirl several times until the tablets are dissolved.
30. Place the vial in the sample chamber making sure that the X marks are aligned.

Zero accepted  
prepare Test  
press TEST

31. Press **TEST** key.

**Record the displayed test result (D).**

## 1.1 Methods

### Calculations:

mg/l Chlorine dioxide = result G x 1,9  
mg/l free Chlorine = result A – result G  
mg/l combined Chlorine = result C – result A  
mg/l Chlorite = result D – ( result C + 4 x result G )

### Tolerances:

1. By calculation of non direct analysable parameters it is necessary to consider the error propagation based on the possible tolerances of the single test results.
2. see Notes Chlorine, page 45.

Reagent / Accessories	Form of reagent/Quantity	Order-No.
<b>Set</b> DPD No. 1 / No. 3	Tablet / per 100 inclusive stirring rod	517711BT
DPD No. 1	Tablet / 100	511050BT
DPD No. 3	Tablet / 100	511080BT
GLYCINE	Tablet / 100	512170BT
DPD ACIDIFYING	Tablet / 100	512120
DPD NEUTRALISING	Tablet / 100	511020BT

## 1.1 Methods

1

2

5

### Chromium with Powder Pack

0.02 – 2 mg/l Cr

Chrom

>>

diff  
Cr (VI)  
Cr (III + VI)

The following selection is shown in the display:

>>

diff

for the differentiated determination of Chromium (VI), Chromium (III) and total Chromium

>>

Cr (VI)

for the determination of Chromium (VI)

>>

Cr (III + VI)

for the determination of total Chromium (sum Cr (III) + Cr (VI))

Select the desired determination with the arrow keys [▲] and [▼]. Confirm with the [↵] key.

#### Note:

1. If ??? is displayed at the differentiated test result see page 356.



## 1.1 Methods

1

2

5

### Chromium, differentiated determination with Powder Pack

0.02 – 2 mg/l Cr





#### Digestion:

1. Fill a clean vial (16 mm Ø) with **10 ml of water sample**.
2. Add the contents of **one PERSULF.RGT FOR CR Powder Pack** straight from the foil into the vial.
3. Close the vial tightly with the cap and swirl several times to mix the contents.
4. Heat the vial for **120 minutes** in a preheated thermo-reactor at a temperature of **100°C**.
5. Remove the vial from the thermoreactor.  
**(CAUTION: The vials are hot!).**  
Invert the vial and allow to cool to room temperature.

#### Performing test procedure:

Insert the adapter for 16 mm Ø vials.

6. Place the pre prepared vial in the sample chamber making sure that the marks  are aligned.
7. Press **ZERO** key.
8. Remove the vial from the sample chamber.
9. Add the contents of **one CHROMIUM HEXAVALENT Powder Pack** straight from the foil into the pre prepared vial.
10. Close the vial tightly with the cap and swirl several times to mix the contents.
11. Place the vial in the sample chamber making sure that the marks  are aligned.
12. Press **TEST** key.

Wait for a **reaction period of 5 minutes**.

After the reaction period is finished the measurement starts automatically.

prepare Zero  
press ZERO

Zero accepted  
prepare T1  
press TEST

Countdown  
5:00



## 1.1 Methods



**T1 accepted  
prepare T2  
press TEST**

**Countdown  
5:00**

**\*,\*\* mg/l Cr (VI)  
\*,\*\* mg/l Cr (III)  
\*,\*\* mg/l Cr tot.**

13. Fill a second clean vial (16 mm Ø) with **10 ml of the water sample**.
14. Add the contents of **one CHROMIUM HEXAVALENT Powder Pack** straight from the foil to the water sample.
15. Close the vial tightly with the cap and swirl several times to mix the contents.
16. Place the vial in the sample chamber making sure that the marks are aligned.
17. Press **TEST** key.

Wait for a **reaction period of 5 minutes**.

After the reaction period is finished the measurement starts automatically.

The result is shown in the display in:

mg/l Cr (VI)  
mg/l Cr (III)  
mg/l Cr total Chromium

### Notes:

1. Performing steps 1–12 determines concentration of total chromium and steps 13–17 determines concentration of Chromium (VI). The concentration of Chromium (III) results out of the difference.
2. pH value of the water sample should be between 3 and 9.
3. For information about interferences especially in waste water and chemical waste water through metals and reductive or oxidic agents see DIN 38 405 – D 24 and Standard Methods of Water and Wastewater, 20th Edition; 1998.

Reagent / Accessories	Form of reagent/Quantity	Order-No.
PERSULF.RGT FOR CR	Powder Pack / 100	537300
CHROMIUM HEXAVALENT	Powder Pack / 100	537310

## 1.1 Methods

1

2



5

### Chromium (VI) with Powder Pack

0.02 – 2 mg/l Cr



Insert the adapter for 16 mm Ø vials.

1. Fill a clean vial (16 mm Ø) with **10 ml of the water sample**.
2. Place the vial in the sample chamber making sure that the marks  are aligned.
3. Press **ZERO** key.
4. Remove the vial from the sample chamber.
5. Add the contents of **one CHROMIUM HEXAVALENT Powder Pack** straight from the foil to the water sample.
6. Close the vial tightly with the cap and swirl several times to mix the contents.
7. Place the vial in the sample chamber making sure that the marks  are aligned.
8. Press **TEST** key.

prepare Zero  
press ZERO

Wait for a **reaction period of 5 minutes**.

After the reaction period is finished the measurement starts automatically.

The result is shown in the display in mg/l Chromium (VI).

**Notes:**  
see previous page

Zero accepted  
prepare Test  
press TEST  
Countdown  
5:00

Reagent / Accessories	Form of reagent/Quantity	Order-No.
PERSULF.RGT FOR CR	Powder Pack / 100	537300
CHROMIUM HEXAVALENT	Powder Pack / 100	537310

## 1.1 Methods



### Chromium, total (Cr(III) + Cr(VI)) with Powder Pack

0.2 – 2 mg/l Cr





#### Digestion:

1. Fill a clean vial (16 mm Ø) with **10 ml of water sample**.
2. Add the contents of **one PERSULF.RGT FOR CR Powder Pack** straight from the foil into the vial.
3. Close the vial tightly with the cap and swirl several times to mix the contents.
4. Heat the vial for **120 minutes** in a preheated thermoreactor at a temperature of **100 °C**.
5. Remove the vial from the thermoreactor.  
**(CAUTION: The vials are hot!).**  
Invert the vial and allow to cool to room temperature.

#### Performing test procedure:

Insert the adapter for 16 mm Ø vials.

6. Place the pre prepared vial in the sample chamber making sure that the marks  are aligned.
7. Press **ZERO** key.
8. Remove the vial from the sample chamber.
9. Add the contents of **one CHROMIUM HEXAVALENT Powder Pack** straight from the foil to the water sample.
10. Close the vial tightly with the cap and swirl several times to mix the contents.
11. Place the vial in the sample chamber making sure that the marks  are aligned.
12. Press **TEST** key.  
Wait for a **reaction period of 5 minutes**.

After the reaction period is finished the measurement starts automatically.

The result is shown in the display in mg/l total Chromium.

prepare Zero  
press ZERO

Zero accepted  
prepare Test  
press TEST

Countdown  
5:00

## 1.1 Methods

1

3

0

### COD LR with Vario Tube Test

3 – 150 mg/l O<sub>2</sub>



Insert the adapter for 16 mm Ø vials.

1. Open one white capped reaction vial and add **2 ml deionised water** (this is the blank (Note 1)).
2. Open another white capped reaction vial and add **2 ml of the water sample** (this is the sample).
3. Close the vials with the cap tightly. Invert the vial gently several times to mix the contents.  
**(CAUTION: The vial will become hot during mixing!)**
4. Heat the vials for **120 minutes** in the preheated reactor at a temperature of **150°C**.
5. **(CAUTION: The vials are hot!)**  
Remove the tubes from the heating block and allow them to cool to 60°C or less. Mix the contents by carefully inverting each tube several times while still warm. Then allow the tubes to cool to ambient temperature before measuring. (Note 2).
6. Place the vial (the blank (Note 3, 4)) in the sample chamber making sure that the marks are  $\Delta$  aligned.
7. Press **ZERO** key.
8. Remove the vial from the sample chamber.
9. Place the vial (the sample (Note 3, 4)) in the sample chamber making sure that the marks are  $\Delta$  aligned.
10. Press **TEST** key.

prepare Zero  
press ZERO

Zero accepted  
prepare Test  
press TEST

The result is shown in the display in mg/l COD.

## 1.1 Methods

### Notes:

1. Run samples and blanks with the same batch of vials. The blank is stable when stored in the dark and can be used for further measurements with vials of the same batch.
2. Do not place the hot vials in the sample chamber. Cool the vials to room temperature for final measurements.
3. Suspended solids in the vial lead to incorrect measurements. For this reason it is important to place the vials carefully in the sample chamber. The precipitate at the bottom of the sample should be not suspended.
4. Clean the outside of the vials with a towel. Finger prints or other marks will be removed.
5. Samples can be measured when the Chloride content does not exceed 1000 mg/l.
6. In exceptional cases, compounds contained in the water cannot be oxidized adequately, so results may be lower than reference methods.

Reagent / Accessories	Form of reagent/Quantity	Order-No.
CSB VARIO LR 3 - 150 mg/l	1 Set (25 tests)	2420720

## 1.1 Methods

1

3

1

### COD MR with Vario Tube Test

20 – 1500 mg/l O<sub>2</sub>



Insert the adapter for 16 mm Ø vials.

1. Open one white capped reaction vial and add **2 ml deionised water** (this is the blank (Note 1)).
2. Open another white capped reaction vial and add **2 ml of the water sample** (this is the sample).
3. Close the vials with the cap tightly. Invert the vial gently several times to mix the contents.  
**(CAUTION: The vial will become hot during mixing!)**
4. Heat the vials for **120 minutes** in the preheated reactor at a temperature of **150°C**.
5. **(CAUTION: The vials are hot!)**  
Remove the tubes from the heating block and allow them to cool to 60°C or less. Mix the contents by carefully inverting each tube several times while still warm. Then allow the tubes to cool to ambient temperature before measuring. (Note 2).
6. Place the vial (the blank (Note 3, 4)) in the sample chamber making sure that the marks are  $\Delta$  aligned.
7. Press **ZERO** key.
8. Remove the vial from the sample chamber.
9. Place the vial (the sample (Note 3, 4)) in the sample chamber making sure that the marks are  $\Delta$  aligned.
10. Press **TEST** key.

prepare Zero  
press ZERO

Zero accepted  
prepare Test  
press TEST

The result is shown in the display in mg/l COD.

## 1.1 Methods

### Notes:

1. Run samples and blanks with the same batch of vials. The blank is stable when stored in the dark and can be used for further measurements with vials of the same batch.
2. Do not place the hot vials in the sample chamber. Cool the vials to room temperature for final measurements.
3. Suspended solids in the vial lead to incorrect measurements. For this reason it is important to place the vials carefully in the sample chamber. The precipitate at the bottom of the sample should be not suspended.
4. Clean the outside of the vials with a towel. Finger prints or other marks will be removed.
5. Samples can be measured when the Chloride content does not exceed 1000 mg/l.
6. In exceptional cases, compounds contained in the water cannot be oxidized adequately, so results may be lower than reference methods.
7. For samples under 100 mg/l COD it is recommended to repeat the test with the tube test for COD LR.

Reagent / Accessories	Form of reagent/Quantity	Order-No.
CSB VARIO MR 20 - 1500 mg/l	1 Set (25 tests)	2420721

## 1.1 Methods

1

3

2

### COD HR with Vario Tube Test

0.2 – 15 g/l O<sub>2</sub> (≙ 200 – 15 000 mg/l O<sub>2</sub>)



Insert the adapter for 16 mm Ø vials.

1. Open one white capped reaction vial and add **0.2 ml deionised water** (this is the blank (Note 1)).
2. Open another white capped reaction vial and add **0.2 ml of the water sample** (this is the sample).
3. Close the vials with the cap tightly. Invert the vial gently several times to mix the contents.  
**(CAUTION: The vial will become hot during mixing!)**
4. Heat the vials for **120 minutes** in the preheated reactor at a temperature of **150°C**.
5. **(CAUTION: The vials are hot!)**  
Remove the tubes from the heating block and allow them to cool to 60°C or less. Mix the contents by carefully inverting each tube several times while still warm. Then allow the tubes to cool to ambient temperature before measuring. (Note 2).
6. Place the vial (the blank (Note 3, 4)) in the sample chamber making sure that the marks are  $\blacktriangle$  aligned.
7. Press **ZERO** key.
8. Remove the vial from the sample chamber.
9. Place the vial (the sample (Note 3, 4)) in the sample chamber making sure that the marks are  $\blacktriangle$  aligned.
10. Press **TEST** key.

prepare Zero  
press ZERO

Zero accepted  
prepare Test  
press TEST

The result is shown in the display in **g/l** COD.



## 1.1 Methods

### Notes:

1. Run samples and blanks with the same batch of vials. The blank is stable when stored in the dark and can be used for further measurements with vials of the same batch.
2. Do not place the hot vials in the sample chamber. Cool the vials to room temperature for final measurements.
3. Suspended solids in the vial lead to incorrect measurements. For this reason it is important to place the vials carefully in the sample chamber. The precipitate at the bottom of the sample should be not suspended.
4. Clean the outside of the vials with a towel. Finger prints or other marks will be removed.
5. Samples can be measured when the Chloride content does not exceed 10 000 mg/l.
6. In exceptional cases, compounds contained in the water cannot be oxidized adequately, so results may be lower than reference methods.
7. For samples under 1 g/l COD it is recommended to repeat the test with the test kit for COD MR or for samples under 0,1 g/l COD with the tube test COD LR.

Reagent / Accessories	Form of reagent/Quantity	Order-No.
CSB VARIO HR 200 - 15000 mg/l	1 Set (25 tests)	2420722

## 1.1 Methods



### Colour, true and apparent (APHA Platinum-Cobalt Standard Method)

0 – 500 Pt-Co units

#### Sample preparation (Note 4):

##### Step A

Filter approx. **50 ml deionised water** through a membrane filter with a pore width of 0.45 µm. Discard the filtrate. Filter another **50 ml deionised water** and keep it for zeroing.

##### Step B

Filter approx. **50 ml water sample** using the same filter. Keep this filtrate for sample measurement.



Ø 24 mm

1. Fill a clean vial (24 mm Ø) with **10 ml of the filtrated deionised water** (from Step A), close tightly with the cap.
2. Place the vial in the sample chamber making sure that the X marks are aligned.
3. Press **ZERO** key.
4. Remove the vial from the sample chamber and empty it completely.
5. Rinse the vial with the filtrated water sample and fill with **10 ml filtrated water sample** (from Step B).
6. Place the vial in the sample chamber making sure that the X marks are aligned.
7. Press **TEST** key.

prepare Zero  
press ZERO

Zero accepted  
prepare Test  
press TEST

The result is shown in the display in Pt-Co units.

## 1.1 Methods

### Notes:

1. This colour scale was originally developed by A. Hazen as a visual comparison scale. It is therefore necessary to ascertain whether the extinction maximum of the water sample is in the range from 420 to 470 nm, as this method is only suitable for water samples with yellowish to yellowish-brown coloration. Where applicable, a decision should be made based on visual inspection of the water sample.
2. This method 204 – Colour (Hazen) – is calibrated on the basis of the standards specified by "Standard Methods for the Examination of Water and Wastewater" (also see EN ISO 7887:1994).  
1 Pt-Co colour unit = 1 mg/L of platinum as chloroplatinate ion
3. The estimated detection limit is 15 mg/L Pt.
4. Colour may be expressed as "apparent" or "true" colour. The apparent colour is defined as the colour of a solution due to dissolved substances and suspended particles in the sample. This manual describes the determination of true colour by filtration of the water sample. To determine the apparent colour, non-filtrated deionised water and sample are measured.
5. Sample collection, preservation and storage:  
Pour the water sample into clean glass or plastic containers and analyse as soon as possible after the sample is taken. If this is not possible, fill the container right up to the top and seal tightly. Do not stir the sample; avoid lengthy contact with the air.  
The sample may be stored in a dark place at a temperature of 4°C for 24 hours. Before performing measurements, the water sample must be brought up to room temperature.

## 1.1 Methods

1

5

0

### Copper with Tablet

0.05 – 5 mg/l Cu

#### Copper

```
>>  diff
      free
      total
```

The following selection is shown in the display:

```
>>  diff
```

for the differentiated determination of free, combined and total Copper.

```
>>  free
```

for the determination of free Copper.

```
>>  total
```

for the determination of total Copper.

Select the desired determination with the arrow keys [▲] and [▼]. Confirm with [↵] key.

#### Note:

1. If **???** is displayed at the differentiated test result see page 356.

Reagent / Accessories	Form of reagent/Quantity	Order-No.
<b>Set</b> COPPER No. 1 / No. 2	Tablet / per 100 inclusive stirring rod	517691BT
COPPER No. 1	Tablet / 100	513550BT
COPPER No. 2	Tablet / 100	513560BT

## 1.1 Methods

1 5 0

### Copper, differentiated determination with Tablet

0.05 – 5 mg/l Cu



prepare Zero  
press ZERO

1. Fill a clean vial (24 mm Ø) with **10 ml of the water sample**, close tightly with the cap.
2. Place the vial in the sample chamber making sure that the  $\Sigma$  marks are aligned.
3. Press **ZERO** key.
4. Remove the vial from the sample chamber.
5. Add **one COPPER No. 1 tablet** straight from the foil to the water sample and crush the tablet using a clean stirring rod.
6. Close the vial tightly with the cap and swirl several times until the tablet is dissolved.
7. Place the vial in the sample chamber making sure that the  $\Sigma$  marks are aligned.
8. Press **TEST** key.
9. Remove the vial from the sample chamber.
10. Add **one COPPER No. 2 tablet** straight from the foil to the same water sample and crush the tablet using a clean stirring rod.
11. Close the vial tightly with the cap and swirl several times until the tablet is dissolved.
12. Place the vial in the sample chamber making sure that the  $\Sigma$  marks are aligned.
13. Press **TEST** key.

Zero accepted  
prepare T1  
press TEST

T1 accepted  
prepare T2  
press TEST

\*,\*\* mg/l free Cu  
\*,\*\* mg/l comb Cu  
\*,\*\* mg/l total Cu

The result is shown in the display in:  
mg/l free Copper  
mg/l combined Copper  
mg/l total Copper

## 1.1 Methods

1

5

0

### Copper, free with Tablet

0.05 – 5 mg/l Cu



Ø 24 mm

prepare Zero  
press ZERO

1. Fill a clean vial (24 mm Ø) with **10 ml of the water sample**, close tightly with the cap.
2. Place the vial in the sample chamber making sure that the  $\Sigma$  marks are aligned.
3. Press **ZERO** key.
4. Remove the vial from the sample chamber.
5. Add **one COPPER No. 1 tablet** straight from the foil to the water sample and crush the tablet using a clean stirring rod.
6. Close the vial tightly with the cap and swirl several times until the tablet is dissolved.
7. Place the vial in the sample chamber making sure that the  $\Sigma$  marks are aligned.
8. Press **TEST** key.

Zero accepted  
prepare Test  
press TEST

The result is shown in the display in mg/l free Copper.

## 1.1 Methods

1 5 0

### Copper, total with Tablet

0.05 – 5 mg/l Cu



Ø 24 mm

prepare Zero  
press ZERO

1. Fill a clean vial (24 mm Ø) with **10 ml of the water sample**, close tightly with the cap.
2. Place the vial in the sample chamber making sure that the  $\times$  marks are aligned.
3. Press **ZERO** key.
4. Remove the vial from the sample chamber.
5. Add **one COPPER No. 1 tablet and one COPPER No. 2 tablet** straight from the foil to the water sample and crush the tablets using a clean stirring rod.
6. Close the vial tightly with the cap and swirl several times until the tablets are dissolved.
7. Place the vial in the sample chamber making sure that the  $\times$  marks are aligned.
8. Press **TEST** key.

Zero accepted  
prepare Test  
press TEST

The result is shown in the display in mg/l total Copper.

## 1.1 Methods



### Copper with Liquid reagent and powder

0.05 – 4 mg/l Cu

#### Copper

>> **diff**  
**free**  
**total**

The following selection is shown in the display:

>> **diff**

for the differentiated determination of free, combined and total Copper.

>> **free**

for the determination of free Copper.

>> **total**

for the determination of total Copper.

Select the desired determination with the arrow keys [▲] and [▼]. Confirm with [↵] key.

#### Notes:

1. For correct dosage the spoon supplied with the reagents must be used.
2. If **???** is displayed at the diffinitiated test result see page 356.

Reagent / Accessories	Form of reagent/Quantity	Order-No.
KS240 – Coppercol Reagent 1	Liquid reagent / 30 ml	56L024030
KS241 – Coppercol Reagent 2	Liquid reagent / 30 ml	56L024130
KP242 – Coppercol Reagent 3	Powder / 10 g	56L024210
COPPER No. 2	Tablet / 100	513560BT



## 1.1 Methods

1 5 1

### Copper, differentiated determination with Liquid reagent and powder

0.05 – 4 mg/l Cu



prepare Zero  
press ZERO

1. Fill a clean vial (24 mm Ø) with **10 ml of the water sample**, close tightly with the cap.
2. Place the vial in the sample chamber making sure that the  $\Sigma$  marks are aligned.
3. Press **ZERO** key.
4. Remove the vial from the sample chamber.
5. Fill the vial with drops of the same size by holding the bottle vertically and squeeze slowly:  
**10 drops of KS240 (Coppercol Reagent 1)**
6. Close the vial tightly with the cap and swirl several times to mix the contents.
7. Fill the vial with drops of the same size by holding the bottle vertically and squeeze slowly:  
**10 drops of KS241 (Coppercol Reagent 2)**
8. Close the vial tightly with the cap and swirl several times to mix the contents.
9. Add **1 level spoon of reagent KP242 (Coppercol Reagent 3)** (note 1, page 100).
10. Close the vial tightly with the cap and swirl several times to dissolve the powder.
11. Place the vial in the sample chamber making sure that the  $\Sigma$  marks are aligned.
12. Press **TEST** key.

Zero accepted  
prepare T1  
press TEST

## 1.1 Methods

13. Remove the vial from the sample chamber.
14. Add **one COPPER No. 2 tablet** straight from the foil to the same water sample and crush the tablet using a clean stirring rod.
15. Close the vial tightly with the cap and swirl several times until the tablet is dissolved.
16. Place the vial in the sample chamber making sure that the  $\Sigma$  marks are aligned.
17. Press **TEST** key.

T1 accepted  
prepare T2  
press TEST

The result is shown in the display in:

\*,\*\* mg/l free Cu  
\*,\*\* mg/l comb Cu  
\*,\*\* mg/l total Cu

mg/l free Copper  
mg/l combined Copper  
mg/l total Copper

## 1.1 Methods

1 5 1

### Copper, free with Liquid reagent and powder

0.05 – 4 mg/l Cu



prepare Zero  
press ZERO

1. Fill a clean vial (24 mm Ø) with **10 ml of the water sample**, close tightly with the cap.
2. Place the vial in the sample chamber making sure that the  $\times$  marks are aligned.
3. Press **ZERO** key.
4. Remove the vial from the sample chamber.
5. Fill the vial with drops of the same size by holding the bottle vertically and squeeze slowly:  
**10 drops of KS240 (Coppercol Reagent 1)**
6. Close the vial tightly with the cap and swirl several times to mix the contents.
7. Fill the vial with drops of the same size by holding the bottle vertically and squeeze slowly:  
**10 drops of KS241 (Coppercol Reagent 2)**
8. Close the vial tightly with the cap and swirl several times to mix the contents.
9. Add **1 level spoon of reagent KP242 (Coppercol Reagent 3)** (note 1, page 100).
10. Close the vial tightly with the cap and swirl several times to dissolve the powder.
11. Place the vial in the sample chamber making sure that the  $\times$  marks are aligned.
12. Press **TEST** key.

Zero accepted  
prepare Test  
press TEST

The result is shown in the display in mg/l free Copper.

## 1.1 Methods

1 5 1

### Copper, total with Liquid reagent and powder

0.05 – 4 mg/l Cu



prepare Zero  
press ZERO

1. Fill a clean vial (24 mm Ø) with **10 ml of the water sample**, close tightly with the cap.
2. Place the vial in the sample chamber making sure that the X marks are aligned.
3. Press **ZERO** key.
4. Remove the vial from the sample chamber.
5. Fill the vial with drops of the same size by holding the bottle vertically and squeeze slowly:  
**10 drops of KS240 (Coppercol Reagent 1)**
6. Close the vial tightly with the cap and swirl several times to mix the contents.
7. Fill the vial with drops of the same size by holding the bottle vertically and squeeze slowly:  
**10 drops of KS241 (Coppercol Reagent 2)**
8. Close the vial tightly with the cap and swirl several times to mix the contents.
9. Add **1 level spoon of reagent KP242 (Coppercol Reagent 3)** (note 1, page 100).
10. Close the vial tightly with the cap and swirl several times to dissolve the powder.

## 1.1 Methods

11. Add **one COPPER No. 2 tablet** straight from the foil to the same water sample and crush the tablet using a clean stirring rod.
12. Close the vial tightly with the cap and swirl several times until the tablet is dissolved.
13. Place the vial in the sample chamber making sure that the  $\times$  marks are aligned.
14. Press **TEST** key.

**Zero accepted  
prepare Test  
press TEST**

The result is shown in the display in mg/l total Copper.

## 1.1 Methods

1 5 3

### Copper, free (Note 1) with Vario Powder Pack

0.05 – 5 mg/l Cu



prepare Zero  
press ZERO

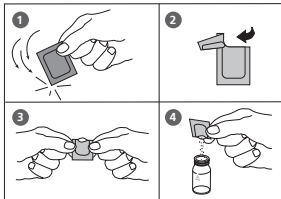

Zero accepted  
prepare Test  
press TEST

Countdown  
2:00

1. Fill a clean vial (24 mm Ø) with **10 ml of the water sample**, close tightly with the cap.
2. Place the vial in the sample chamber making sure that the X marks are aligned.
3. Press **ZERO** key.
4. Remove the vial from the sample chamber.
5. Add the contents of **one VARIO Cu 1 F10 Powder Pack** straight from the foil to the water sample.
6. Close the vial tightly with the cap and swirl several times to mix the contents (Note 3).
7. Place the vial in the sample chamber making sure that the X marks are aligned.

8. Press **TEST** key.

Wait for a **reaction period of 2 minutes**.

After the reaction period is finished the measurement starts automatically.

The result is shown in the display in mg/l Copper

## 1.1 Methods

### Notes:

1. For determination of total Copper digestion is required.
2. Extremely acid water samples (pH 2 or less) must be adjusted between pH 4 and pH 6 before the reagent is added (with 8 mol/l Potassium hydroxide solution KOH).  
Caution: pH values above 6 can lead to Copper precipitation.
3. Accuracy is not affected by undissolved powder.
4. Interferences:

Cyanide, CN <sup>-</sup>	Cyanide prevents full colour development. Add 0.2 ml Formaldehyde to 10 ml water sample and wait for a reaction time of 4 minutes (Cyanide is masked). After this perform test as described. Multiply the result by 1.02 to correct the sample dilution by Formaldehyde.
Silver, Ag <sup>+</sup>	If a turbidity remains and turns black, silver interference is likely. Add 10 drops of saturated Potassium chloride solution to 75 ml of water sample. Filtrate through a fine filter. Use 10 ml of the filtered water sample to perform test.

Reagent / Accessories	Form of reagent/Quantity	Order-No.
VARIO Cu 1 F10	Powder Pack / 100	530300

## 1.1 Methods

1

5

7

### Cyanide with Reagent Test

0.01 – 0.5 mg/l CN



prepare Zero  
press ZERO

1. Fill a clean vial (24 mm Ø) with **2 ml of the water sample and 8 ml of deionised water**, close tightly with the cap.
2. Place the vial in the sample chamber making sure that the  $\times$  marks are aligned.

3. Press **ZERO** key.

4. Remove the vial from the sample chamber.

5. Add **two level spoons No. 4 (white) of Cyanide-11** into the prepared water sample, replace the cap tightly and invert the vial several times to mix the contents.

6. **Add two level spoons No. 4 (white) of Cyanide-12**, replace the cap tightly and invert the vial several times to mix the contents.

7. Fill the vial with drops of the same size by holding the bottle vertically and squeeze slowly:

**3 drops of Cyanide-13**

8. Close the vial tightly with the cap and invert several times to mix the contents.

9. Place the vial in the sample chamber making sure that the  $\times$  marks are aligned.

10. Press **TEST** key.

Wait for a reaction **period of 10 minutes**.

After the reaction period is finished the measurement starts automatically.

The result is shown in the display in mg/l Cyanide.

Zero accepted  
prepare Test  
press TEST

Countdown  
10:00



## 1.1 Methods

### Notes:

1. Only free Cyanide and Cyanides that can be destroyed by Chlorine are determined by this test.
2. In the presence of Thiocyanate, heavy metal complexes, colorants or aromatic amines, the cyanide must be separated out by distillation before analysis is performed.
3. **Store the reagents in closed containers at a temperature of + 15°C to + 25°C.**

Reagent / Accessories	Form of reagent/Quantity	Order-No.
<b>SET:</b> Cyanid-11/ -12 / -13	Reagent test / 200 (Powder, Liquid reagent)	2418875

## 1.1 Methods

1 6 0

### CyA-TEST (Cyanuric acid) with Tablet

0 – 160 mg/l CyA



Ø 24 mm

prepare Zero  
press ZERO

1. Fill a clean vial (24 mm Ø) with **5 ml of the water sample** and **5 ml deionised water (Note 1)**, close tightly with the cap.
2. Place the vial in the sample chamber making sure that the  $\Sigma$  marks are aligned.
3. Press **ZERO** key.
4. Remove the vial from the sample chamber.
5. Add **one CyA-TEST tablet** straight from the foil to the prepared water sample and crush the tablet using a clean stirring rod.
6. Close the vial tightly with the cap and swirl several times until the tablet is dissolved (Note 2, 3).
7. Place the vial in the sample chamber making sure that the  $\Sigma$  marks are aligned.
8. Press **TEST** key.

Zero accepted  
prepare Test  
press TEST

The result is shown in the display in mg/l Cyanuric acid.

## 1.1 Methods

### Notes:

1. Use deionised water or tap water free of Cyanuric acid.
2. If Cyanuric acid is present a cloudy solution will occur.  
Small single particles are not necessarily caused by Cyanuric acid.
3. Dissolve the tablet completely (therefore swirl the vial approx. 1 minute).  
Un-dissolved particles of the tablet can cause results that are too high.

Reagent / Accessories	Form of reagent/Quantity	Order-No.
CyA-TEST	Tablet / 100	511370BT

## 1.1 Methods

1 6 5

### DEHA (N,N-Diethylhydroxylamine) with Tablet and Liquid Reagent

20 – 500 µg/l DEHA / 0.02 – 0.5 mg/l DEHA



prepare Zero  
press ZERO

1. Fill a clean vial (24 mm Ø) with **10 ml of the water sample**, close tightly with the cap (Note 2).
2. Place the vial in the sample chamber making sure that the  $\Sigma$  marks are aligned.
3. Press **ZERO** key.

4. Remove the vial from the sample chamber.

5. Fill the vial with drops of the same size by holding the bottle vertically and squeeze slowly:

**6 drops (0.25ml) of DEHA solution**

6. Close the vial tightly with the cap and swirl several times to mix the contents.
7. Add **one DEHA tablet** straight from the foil to the same water sample and crush the tablet using a clean stirring rod.
8. Close the vial tightly with the cap and swirl several times until the tablet is dissolved.
9. Place the vial in the sample chamber making sure that the  $\Sigma$  marks are aligned.

Zero accepted  
prepare Test  
press TEST

Countdown  
10:00

10. Press TEST key.

Wait for a **reaction period of 10 minutes**.

After the reaction period is finished the measurement starts automatically.

The result is shown in the display as DEHA.

## 1.1 Methods

### Notes:

1. Application: Testing of residual corrosion inhibitors (Oxygen scavengers) in boiler feed water or condensate.
2. Before using clean the vials with Hydrochloric acid (approx. 20%). Rinse thoroughly with deionised water.
3. Keep the sample dark during colour development time. UV-light (sunlight) causes high measurement results.
4. Ideal temperature for full colour development is 20°C ± 2°C.
5. Interferences:

- Iron (II) interferes at all concentrations:  
Repeat the test procedure but without adding the DEHA solution. If the displayed result is above 20 µg/l subtract this value from the DEHA test result.
- Substances which reduce Iron (III) interfere. Substances which complex iron strongly may interfere also.
- Substances which may interfere when present in concentrations at:

Borate (as Na <sub>2</sub> B <sub>4</sub> O <sub>7</sub> )	500 mg/l
Cobalt	0.025 mg/l
Copper	8.0 mg/l
Hardness (as CaCO <sub>3</sub> )	1000 mg/l
Lignosulfonates	0.05 mg/l
Manganese	0.8 mg/l
Molybdenum	80 mg/l
Nickel	0.8 mg/l
Phosphate	10 mg/l
Phosphonates	10 mg/l
Sulfate	1000 mg/l
Zinc	50 mg/l

6. There is an option to change the unit from mg/l to µg/l.

▲ mg/l

▼ µg/l

Reagent / Accessories	Form of reagent/Quantity	Order-No.
DEHA Solution ca. 60 Tests	Liquid reagent / 15 ml	461185
DEHA Solution ca. 400 Tests	Liquid reagent / 100 ml	461181
DEHA	Tablet / 100	513220BT

## 1.1 Methods

1 6 7

### DEHA (N,N-Diethylhydroxylamin) with Vario Powder Pack and Liquid Reagent

20 – 500 µg/l DEHA / 0.02 – 0.5 mg/l DEHA



Use two clean vials (24 mm Ø) and mark one as blank for zeroing (Note 2).

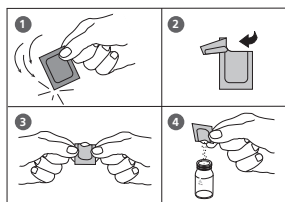

1. Fill a clean vial with **10 ml deionised water** (this is the blank).
2. Fill the second clean vial with **10 ml of the water sample** (this is the sample).
3. Add the contents of **one VARIO OXYSCAV 1 Rgt Powder Pack** straight from the foil into each vial.
4. Close the vials tightly with the caps and swirl several times to mix the contents.
5. Add **0.20 ml VARIO DEHA 2 Rgt Solution** to each vial (Note 4).
6. Close the vials tightly with the caps and swirl several times to mix the contents.

#### Countdown 1

10:00

start: ↵

7. Press **[↵]** key.  
Wait for a reaction **period of 10 minutes** (Note 5).  
After the reaction period is finished proceed as follows:
8. Place the vial (the blank) in the sample chamber making sure that the **∑** marks are aligned.
9. Press **ZERO** key.
10. Remove the vial from the sample chamber.
11. Place the vial (the sample) in the sample chamber making sure that the **∑** marks are aligned.

prepare Zero  
press ZERO

Zero accepted  
prepare Test  
press TEST

12. Press **TEST** key.

The result is shown in the display as DEHA.

# 1.1 Methods

**Notes:**

1. Application: Testing of residual corrosion inhibitors (Oxygen scavengers) in boiler feed water or condensate.
2. Before using clean the vials with Hydrochloric acid (approx. 20%). Rinse thoroughly with deionised water.
3. Ideally temperature for full colour development is 25°C ± 3 °C.
4. Volume should always be metered by using suitable pipette (class A).
5. Keep blank and sample dark during colour development time. UV-light (sunlight) causes high measurement results.
6. Interferences:
  - Iron (II) interferes at all concentrations:  
Repeat the test procedure but without adding the VARIO DEHA Rgt 2 solution. If the displayed result is above 20 µg/l subtract this value from the DEHA test result.
  - Substances which reduce Iron (III) interfere. Substances which complex iron strongly may interfere also.
  - Substances who may interfere when present in concentrations at:

Borate (as Na <sub>2</sub> B <sub>4</sub> O <sub>7</sub> )	500 mg/l
Cobalt	0.025 mg/l
Copper	8.0 mg/l
Hardness (as CaCO <sub>3</sub> )	1000 mg/l
Lignosulfonates	0.05 mg/l
Manganese	0.8 mg/l
Molybdenum	80 mg/l
Nickel	0.8 mg/l
Phosphate	10 mg/l
Phosphonates	10 mg/l
Sulfate	1000 mg/l
Zinc	50 mg/l

7. There is an option to change the unit from mg/l to µg/l.

▲ mg/l

▼ µg/l

Reagent / Accessories	Form of reagent/Quantity	Order-No.
VARIO OXYSCAV 1 Rgt VARIO DEHA 2 Rgt Solution	<b>Set (100 Tests)</b> Powder Pack / 200 Liquid reagent / 100 ml	536000

## 1.1 Methods

1 7 0

### Fluoride with Liquid Reagent

0.05 – 2 mg/l F



Ø 24 mm

**Caution: See notes!**

1. Fill a clean vial (24 mm Ø) with **exactly 10 ml of water sample** (Note 4), close tightly with the cap.
2. Place the vial in the sample chamber making sure that the  $\Sigma$  marks are aligned.
3. Press **ZERO** key.
4. Remove the vial from the sample chamber.
5. Add **exactly 2 ml SPADNS reagent solution** (Note 4) to the water sample.  
**Caution: Vial is filled up to the top! (Note 8)**
6. Close the vial tightly with the cap and swirl several times to mix the contents.
7. Place the vial in the sample chamber making sure that the  $\Sigma$  marks are aligned.

prepare Zero  
press ZERO

Press **TEST** key.

The result is shown in the display in mg/l Fluoride.

Zero accepted  
prepare Test  
press TEST



## 1.1 Methods

### Notes:

1. The same batch of SPADNS reagent solution must be used for adjustment and test.  
The adjustment process needs to be performed for each new batch of SPADNS reagent solution (see Standard Methods 20th, 1998, APHA, AWWA, WEF 4500 F D., S. 4-82).  
The procedure is described in chapter 2.4.5 "Calibration – Fluoride Method 170" on page 328.
2. During adjustment and test the same vial should be used for zeroing and test, as different vials may exhibit minor tolerances.
3. The calibration solution and the water samples to be tested should have the same temperature ( $\pm 1^\circ\text{C}$ ).
4. As the test result is highly dependent on exact sample and reagent volumes, the sample and reagent volumes should always be metered by using a 10 ml resp. 2 ml volumetric pipette (class A).
5. The accuracy of the test methods decreases above a level of 1.2 mg/l Fluoride. Although the results are sufficiently accurate for most applications, even more exact results can be achieved by 1:1 dilution of the sample prior to use and subsequent multiplication of the result by 2.
6. SPADNS reagent solution contains Arsenite.  
Chlorine concentrations up to 5 mg/l do not interfere.
7. Seawater and wastewater samples must be distilled.
8. It is convenient to use special vials with larger volume.

Reagent / Accessories	Form of reagent/Quantity	Order-No.
SPADNS reagent solution	Liquid reagent / 250 ml	467481
Fluoride standard	Solution / 30 ml	205630

## 1.1 Methods



### H<sub>2</sub>O<sub>2</sub> (Hydrogen peroxide) with tablet reagent

0.03 – 3 mg/l H<sub>2</sub>O<sub>2</sub>



Ø 24 mm

prepare Zero  
press ZERO

1. Fill a clean vial (24 mm Ø) with **10 ml of the water sample**, close tightly with the cap.
2. Place the vial in the sample chamber making sure that the  $\Sigma$  marks are aligned.
3. Press **ZERO** key.
4. Remove the vial from the sample chamber and **empty it, leaving a few drops remaining in the vial.**
5. Add **one HYDROGENPEROXIDE LR tablet** straight from the foil and crush the tablet using a clean stirring rod.
6. Add water sample to the 10 ml mark.
7. Close the vial tightly with the cap and swirl several times until the tablet is dissolved.
8. Place the vial in the sample chamber making sure that the  $\Sigma$  marks are aligned.

Zero accepted  
prepare Test  
press TEST

Countdown  
2:00

9. Press **TEST** key.

Wait for a **reaction period of 2 minutes.**

After the reaction period is finished the measurement starts automatically.

The result is shown in the display in mg/l H<sub>2</sub>O<sub>2</sub>.

## 1.1 Methods

### Notes:

1. Vial cleaning:  
As many household cleaners (e.g. dishwasher detergent) contain reducing substances, the subsequent determination of Hydrogen peroxide may show lower results. To avoid any measurement errors, only use glassware free of Chlorine demand.  
Preparation: Put all applicable glassware into Sodium hypochlorite solution (0.1 g/l) for one hour, then rinse all glassware thoroughly with deionised water.
2. Preparing the sample:  
When preparing the sample, the loss of Hydrogen peroxide, e.g. by pipetting or shaking, must be avoided. The analysis must take place immediately after taking the sample.
3. The DPD colour development is carried out at a pH value of 6.2 to 6.5. The reagent tablet therefore contains a buffer for the pH adjustment.  
Strong alkaline or acidic water samples must be adjusted between pH 6 and pH 7 before the tablet is added (use 0.5 mol/l Sulfuric acid resp. 1 mol/l Sodium hydroxide).
4. Exceeding the measuring range:  
Concentrations above 5 mg/l Hydrogen peroxide can lead to results showing 0 mg/l. In this case, the water sample must be diluted with water free of Hydrogen peroxide. 10 ml of the diluted sample should be mixed with the reagent and the measurement repeated.
5. Oxidising agents such as Chlorine, Ozone etc. interfere as they react in the same way as Hydrogen peroxide.

Reagent / Accessories	Form of reagent/Quantity	Order-No.
Hydrogenperoxide LR	Tablet / 100	512380BT

## 1.1 Methods

2

1

3

### $H_2O_2$ (Hydrogen peroxide) LR with Liquid Reagent

1 – 50 mg/l  $H_2O_2$



Insert the adapter for 16 mm Ø vials.

1. Fill a clean vial (16 mm Ø) with **10 ml of the water sample**, close tightly with the cap. (Note 1, 2)
2. Place the vial in the sample chamber making sure that the  $\Sigma$  marks are aligned.
3. Press the **ZERO** key.
4. Remove the vial from the sample chamber.

prepare Zero  
press ZERO

5. Fill the prepared vial with drops of the same size by holding the bottle vertically and squeeze slowly:

#### **6 drops of $H_2O_2$ -Reagent**

6. Close the vial tightly with the cap and invert several times to mix the contents.
7. Place the vial in the sample chamber making sure that the  $\Sigma$  marks are aligned.
8. Press the **TEST** key.

Zero accepted  
prepare Test  
press TEST

The result is shown in the display in mg/l  $H_2O_2$ .

## 1.1 Methods

### Notes:

1. The hydrogen peroxide is determined in the form of yellow/orange coloured peroxotitanic acids in strongly acidic media. In connection with neutral to weakly alkaline (~pH 10) samples, the acid in the reagent is sufficient in order to produce a medium suitable for measurement. In the case of strongly alkaline samples (pH > 10), the samples must be acidified before measurement otherwise the results may be deficient. This is achieved by diluting the sample with a 5% sulphuric acid solution, for example, at a ratio of 1:1.  
In contrast to many other colour reactions, in connection with the presence of hydrogen peroxide, discoloration with long-term stability is achieved that can still be measured after 24 h. Particles in the sample solution or turbidity distort the analysis and must be eliminated by centrifuging or simply filtering the sample solution prior to performing the measurement. Falsification of the measurement results should also be expected in connection with coloured solutions.
2. Oxidising agents such as chlorine, bromine, chlorine dioxide and ozone do not distort the analysis. On the other hand, however, water discoloration does distort the analysis. In this case, proceed as described in the following:
  - Fill a clean vial (16 mm Ø) with 10 ml of the water sample and perform zero calibration (see "Operation").
  - Measure the sample solution without the addition of drops of reagent (result B).
  - Then the same sample solution, measured with the addition of the reagent drops (result A).
  - Calculations:  $\text{mg/l H}_2\text{O}_2 = \text{result A} - \text{result B}$
3. Attention: The reference reagent contains a 25% sulphuric acid solution. It is recommended to wear appropriate protective clothing (protective goggles/gloves).

Reagent / Accessories	Form of reagent/Quantity	Order-No.
H <sub>2</sub> O <sub>2</sub> -reagent	Liquid reagent / 15 ml	424991

## 1.1 Methods

2

1

4

### $H_2O_2$ (Hydrogen peroxide) HR with Liquid Reagent

40 – 500 mg/l  $H_2O_2$



Insert the adapter for 16 mm Ø vials.

1. Fill a clean vial (16 mm Ø) with **10 ml of the water sample**, close tightly with the cap. (Note 1, 2)
2. Place the vial in the sample chamber making sure that the  $\Sigma$  marks are aligned.
3. Press the **ZERO** key.
4. Remove the vial from the sample chamber.

prepare Zero  
press ZERO

5. Fill the prepared vial with drops of the same size by holding the bottle vertically and squeeze slowly:

#### **6 drops of $H_2O_2$ -Reagent**

6. Close the vial tightly with the cap and invert several times to mix the contents.
7. Place the vial in the sample chamber making sure that the  $\Sigma$  marks are aligned.
8. Press the **TEST** key.

Zero accepted  
prepare Test  
press TEST

The result is shown in the display in mg/l  $H_2O_2$ .

## 1.1 Methods

### Notes:

1. The hydrogen peroxide is determined in the form of yellow/orange coloured peroxotitanic acids in strongly acidic media. In connection with neutral to weakly alkaline (~pH 10) samples, the acid in the reagent is sufficient in order to produce a medium suitable for measurement. In the case of strongly alkaline samples (pH > 10), the samples must be acidified before measurement otherwise the results may be deficient. This is achieved by diluting the sample with a 5% sulphuric acid solution, for example, at a ratio of 1:1.  
In contrast to many other colour reactions, in connection with the presence of hydrogen peroxide, discoloration with long-term stability is achieved that can still be measured after 24 h. Particles in the sample solution or turbidity distort the analysis and must be eliminated by centrifuging or simply filtering the sample solution prior to performing the measurement. Falsification of the measurement results should also be expected in connection with coloured solutions.
2. Oxidising agents such as chlorine, bromine, chlorine dioxide and ozone do not distort the analysis. On the other hand, however, water discoloration does distort the analysis. In this case, proceed as described in the following:
  - Fill a clean vial (16 mm Ø) with 10 ml of the water sample and perform zero calibration (see "Operation").
  - Measure the sample solution without the addition of drops of reagent (result B).
  - Then the same sample solution, measured with the addition of the reagent drops (result A).
  - Calculations:  $\text{mg/l H}_2\text{O}_2 = \text{result A} - \text{result B}$
3. Attention: The reference reagent contains a 25% sulphuric acid solution. It is recommended to wear appropriate protective clothing (protective goggles/gloves).

Reagent / Accessories	Form of reagent/Quantity	Order-No.
H <sub>2</sub> O <sub>2</sub> -reagent	Liquid reagent / 15 ml	424991

## 1.1 Methods

1 9 0

### Hardness, Calcium with Tablet

50 – 900 mg/l CaCO<sub>3</sub>



1. Fill a clean vial (24 mm Ø) with **10 ml deionised water**.
2. Add **one CALCHECK tablet** straight from the foil to the deionised water and crush the tablet using a clean stirring rod.
3. Close the vial tightly with the cap and swirl several times until the tablet is dissolved.
4. Place the vial in the sample chamber making sure that the  $\Sigma$  marks are aligned.

prepare Zero  
press ZERO

Countdown  
2:00

5. Press **ZERO** key.  
Wait for a **reaction period of 2 minutes**.  
After the reaction period is finished the measurement starts automatically.
6. Remove the vial from the sample chamber.
7. Add **2 ml of the water sample** to the prepared vial.  
**Caution: Vial is filled up to the top! (Note 4)**
8. Close the vial tightly with the cap and swirl several times (5x) to mix the contents.
9. Place the vial in the sample chamber making sure that the  $\Sigma$  marks are aligned.

Zero accepted  
prepare Test  
press TEST

10. Press **TEST** key.

The result is shown in the display as Calcium Hardness.



## 1.1 Methods

### Notes:

1. Strong alkaline or acidic water samples must be adjusted between pH 4 and pH 10 before the tablet is added (use 1 mol/l Hydrochloric acid resp. 1 mol/l Sodium hydroxide).
2. The tolerance of the method is increasing with higher concentrations. When diluting samples, this should be taken into account, always measuring in the first third of the range.
3. This method was developed from a volumetric procedure for the determination of calcium. Due to undefined conditions, the deviations from the standardised method may be greater.
4. It is convenient to use special vials with larger volume.
5. ▲ CaCO<sub>3</sub>  
    °dH  
    °eH  
    °fH  
    ▼ °aH

Reagent / Accessories	Form of reagent/Quantity	Order-No.
CALCHECK	Tablet / 100	515650

## 1.1 Methods



### Hardness, Calcium 2T with Tablet

0 – 500 mg/l CaCO<sub>3</sub>



Ø 24 mm

prepare Zero  
press ZERO

1. Fill a clean vial (24 mm Ø) with **10 ml of water sample**, close tightly with the cap.
2. Place the vial in the sample chamber making sure that the X marks are aligned.
3. Press **ZERO** key.

4. Remove the vial from the sample chamber.
5. Add **one CALCIO H No. 1 tablet** straight from the foil to the 10 ml water sample, crush the tablet using a clean stirring rod and dissolve the tablet completely.
6. Add **one CALCIO H No. 2 tablet** straight from the foil to the same water sample and crush the tablet using a clean stirring rod.
7. Close the vial tightly with the cap and swirl gently several times until the tablet is completely dissolved.
8. Place the vial in the sample chamber making sure that the X marks are aligned.

Zero accepted  
prepare Test  
press TEST

Countdown  
2:00

9. Press **TEST** key.

Wait for a **reaction period of 2 minutes**.

After the reaction period is finished the measurement starts automatically.

The result is shown in the display as Calcium Hardness.

## 1.1 Methods

### Notes:

1. To optimise the readings an optional batch related calibration can be performed using Mode 40, see page 326.
2. Strong alkaline or acidic water samples must be adjusted to a pH-value between pH 4 and 10 before the tablets are added (use 1 mol/l Hydrochloride acid resp. 1 mol/l Sodium hydroxide).
3. For accurate test results exactly 10 ml of water sample must be taken for the test.
4. This method was developed from a volumetric procedure for the determination of Calcium Hardness. Due to undefined conditions, the deviations from the standardised method may be greater.
5. The tolerance of the method is increasing with higher concentrations. When diluting samples, this should be taken in account, always measuring in the first third of the range.
6. Interferences:
  - Magnesium hardness up to 200 mg/l  $\text{CaCO}_3$  does not interfere.
  - Iron concentration above 10 mg/l may cause low results.
  - Zinc concentration above 5 mg/l may cause high results.
7. ▲  $\text{CaCO}_3$ 
  - °dH
  - °eH
  - °fH
  - ▼ °aH

Reagent / Accessories	Form of reagent/Quantity	Order-No.
<b>Set</b> CALCIO H No. 1 / No. 2	Tablet / per 100 inclusive stirring rod	517761BT

## 1.1 Methods



### Hardness, total with Tablet

2 – 50 mg/l CaCO<sub>3</sub>



Ø 24 mm

prepare Zero  
press ZERO

1. Fill a clean vial (24 mm Ø) with **10 ml of the water sample**, close tightly with the cap.
2. Place the vial in the sample chamber making sure that the  $\Sigma$  marks are aligned.
3. Press **ZERO** key.
4. Remove the vial from the sample chamber.
5. Add **one HARDCHECK P tablet** straight from the foil to the water sample and crush the tablet using a clean stirring rod.
6. Close the vial tightly with the cap and swirl several times until the tablet is dissolved.
7. Place the vial in the sample chamber making sure that the  $\Sigma$  marks are aligned.
8. Press **TEST** key.

Wait for a **reaction period of 5 minutes**.

Zero accepted  
prepare Test  
press TEST

Countdown  
5:00

After the reaction period is finished the measurement starts automatically.

The result is shown in the display as total Hardness.

## 1.1 Methods

### Notes:

1. Strong alkaline or acidic water samples must be adjusted between pH 4 and pH 10 before the tablet is added (use 1 mol/l Hydrochloric acid resp. 1mol/l Sodium hydroxide).
2. Conversion table:

	mg/l CaCO <sub>3</sub>	°dH	°fH	°eH
1 mg/l CaCO <sub>3</sub>	----	0.056	0.10	0.07
1 °dH	17.8	----	1.78	1.25
1 °fH	10.0	0.56	----	0.70
1 °eH	14.3	0.80	1.43	----

3. ▲ CaCO<sub>3</sub>  
     °dH  
     °eH  
     °fH  
     ▼ °aH

Reagent / Accessories	Form of reagent/Quantity	Order-No.
HARDCHECK P	Tablet / 100	515660BT

## 1.1 Methods

2 0 1

### Hardness, total HR with Tablet

20 – 500 mg/l CaCO<sub>3</sub>



Ø 24 mm

prepare Zero  
press ZERO

1. Fill a clean vial (24 mm Ø) with **1 ml of the water sample** and **9 ml of deionised water**, close tightly with the cap.
2. Place the vial in the sample chamber making sure that the  $\Sigma$  marks are aligned.
3. Press **ZERO** key.

4. Remove the vial from the sample chamber.
5. Add **one HARDCHECK P tablet** straight from the foil to the water sample and crush the tablet using a clean stirring rod.
6. Close the vial tightly with the cap and swirl several times until the tablet is dissolved.
7. Place the vial in the sample chamber making sure that the  $\Sigma$  marks are aligned.

Zero accepted  
prepare Test  
press TEST

8. Press **TEST** key.

Wait for a **reaction period of 5 minutes**.

Countdown  
5:00

After the reaction period is finished the measurement starts automatically.

The result is shown in the display as total Hardness.

## 1.1 Methods

### Notes:

1. Strong alkaline or acidic water samples must be adjusted between pH 4 and pH 10 before the tablet is added (use 1 mol/l Hydrochloric acid resp. 1mol/l Sodium hydroxide).
2. Conversion table:

	mg/l CaCO <sub>3</sub>	°dH	°fH	°eH
1 mg/l CaCO <sub>3</sub>	----	0.056	0.10	0.07
1 °dH	17.8	----	1.78	1.25
1 °fH	10.0	0.56	----	0.70
1 °eH	14.3	0.80	1.43	----

3. ▲ CaCO<sub>3</sub>  
°dH  
°eH  
°fH  
▼ °aH

Reagent / Accessories	Form of reagent/Quantity	Order-No.
HARDCHECK P	Tablet / 100	515660BT

## 1.1 Methods

2 0 5

### Hydrazine with Powder Reagent

0.05 – 0.5 mg/l  $N_2H_4$  / 50 – 500  $\mu\text{g/l}$   $N_2H_4$



Ø 24 mm

prepare Zero  
press ZERO

1. Fill a clean vial (24 mm Ø) with **10 ml of the water sample** (Note 1, 2), close tightly with the cap.
2. Place the vial in the sample chamber making sure that the  $\Sigma$  marks are aligned.
3. Press **ZERO** key.

4. Remove the vial from the sample chamber.

5. Add **1 g HYDRAZINE test powder** (Note 3) to the water sample.

6. Close the vial tightly with the cap and swirl several times to mix the contents.

Countdown  
10:00  
start: ↵

7. Press **[↵]** key.  
Wait for a **reaction period of 10 minutes**.

After the reaction period is finished proceed as follows:

8. The slight turbidity that occurs when the reagent is added must be removed by filtration (Note 4).

9. Place the vial in the sample chamber making sure that the  $\Sigma$  marks are aligned.

Zero accepted  
prepare Test  
press TEST

10. Press **TEST** key.

The result is shown in the display as Hydrazine.



## 1.1 Methods

### Notes:

1. If the water sample is cloudy, you must filter it before performing the zero calibration.
2. The temperature of the water sample should not exceed 21°C.
3. Using the Hydrazine spoon: 1 g is equivalent to one level spoon.
4. Qualitative folded filter papers for medium precipitates are recommended.
5. In order to check whether the reagent has aged (if it has been stored for a lengthy period), perform the test as described above using tap water. If the result is above the detection limit of 0.05 mg/l, you should only use the reagent with reservations as there may be a major deviation in results.
6. There is an option to change the unit from mg/l to µg/l.

▲ mg/l  
▼ µg/l

Reagent / Accessories	Form of reagent/Quantity	Order-No.
Hydrazin Test Powder	Powder / 30 g	462910
Spoon		384930

## 1.1 Methods

2 0 6

### Hydrazine with Vario Liquid Reagent

0.005 – 0.6 mg/l  $N_2H_4$  / 5 – 600  $\mu\text{g/l}$   $N_2H_4$



Ø 24 mm

Use two clean vials (24 mm Ø) and mark one as blank for zeroing.

1. Fill a clean vial with **10 ml deionised water** (this is the blank).
2. Add **1 ml VARIO Hydra 2 Rgt Solution** into the vial (Note 3).
3. Close the vial tightly with the cap and swirl several times to mix the contents.
4. Place the vial (the blank) in the sample chamber making sure that the  $\Sigma$  marks are aligned.

prepare Zero  
press ZERO

5. Press **ZERO** key.
6. Remove the vial from the sample chamber.
7. Fill the second clean vial with **10 ml of the water sample** (this is the sample).
8. Add **1 ml VARIO Hydra 2 Rgt Solution** into the vial.
9. Close the vial tightly with the cap and swirl several times to mix the contents.
10. Place the vial (the blank) in the sample chamber making sure that the  $\Sigma$  marks are aligned.

Zero accepted  
prepare Test  
press TEST

11. Press **TEST** key.  
Wait for a **reaction period of 12 minutes**.

Countdown  
12:00

After the reaction period is finished the measurement starts automatically.

The result is shown in the display as Hydrazine.

## 1.1 Methods

### Notes:

1. Samples cannot be preserved and must be analysed immediately.
2. Sample temperature should be  $21^{\circ}\text{C} \pm 4^{\circ}\text{C}$ .
3. The blank may develop a faint yellow colour due to the reagent.
4. Interferences:
  - Ammonia causes no interferences up to 10 mg/l.  
At a concentration of 20 mg/l it is possible that the test result increases by 20%.
  - Morpholine does not interfere up to 10 mg/l.
  - Highly coloured or turbid samples:  
Mix 1 part deionised water with 1 part household bleach. Add 1 drop of this mixture into 25 ml water sample and mix. Use 10 ml prepared sample in place of deionised water in point 1.  
Note: at point 7 use the unprepared water sample.  
Principle: Hydrazine is oxidised by household bleach. Colour interference will be eliminated by zeroing.
5. There is an option to change the unit from mg/L to  $\mu\text{g/L}$ .
  - ▲ mg/l
  - ▼  $\mu\text{g/l}$

Reagent / Accessories	Form of reagent/Quantity	Order-No.
VARIO Hydra 2 Rgt Solution	Liquid reagent / 100 ml	531200

## 1.1 Methods

2 0 7

### Hydrazine with Vacu-vials® K-5003 (see Notes)

0.01 – 0.7 mg/l  $N_2H_4$  / 10 – 700  $\mu\text{g/l}$   $N_2H_4$

Insert the adapter for 13 mm  $\varnothing$  vials.

1. Place the blank in the sample chamber. The blank is part of the test kit.

prepare Zero  
press ZERO

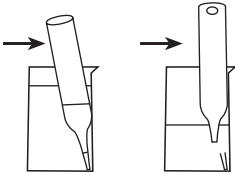
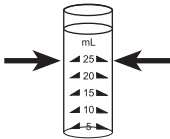

2. Press **ZERO** key.
3. Remove the blank from the sample chamber.
4. Fill the sample container to the 25 ml mark with the water sample.
5. Place one Vacu-vial® in the sample container. Snap the tip by pressing the vial against the side of the sample container. The Vacu-vial® breaks at the neck and the vial fills automatically. A small volume of inert gas remains in the Vacu-vial®.
6. Mix the contents of the Vacu-vial® by inverting it several times, allowing the bubble to move from one end to the other. Dry the outside of the vial.
7. Place the Vacu-vial® in the sample chamber.

Zero accepted  
prepare Test  
press TEST

Countdown  
10:00

8. Press **TEST** key.

Wait for a **reaction period of 10 minutes**.

After the reaction period is finished the measurement starts automatically.

The result is shown in the display as Hydrazine.

## 1.1 Methods

### Notes:

1. This method is adapted from CHEMetrics. The measuring range and wavelength used for this photometer may differ from the data specified by CHEMetrics.
2. Read the original test instruction and the MSDS (delivered with the test) before performing the test. MSDS also available at [www.chemetrics.com](http://www.chemetrics.com).
3. Vacu-vials® is a registered trade mark of the company CHEMetrics, Inc. / Calverton, U.S.A.
4. There is an option to change the unit from mg/l to µg/l.

▲ mg/l  
▼ µg/l

Reagent / Accessories	Form of reagent/Quantity	Order-No.
Vacu-vials® / CHEMetrics K-5003	Test-Kit / 30	380470

## 1.1 Methods



### Iodine with Tablet

0.05 – 3.6 mg/l I



prepare Zero  
press ZERO

1. Fill a clean vial (24 mm Ø) with **10 ml of the water sample**, close tightly with the cap.
2. Place the vial in the sample chamber making sure that the X marks are aligned.
3. Press **ZERO** key.
4. Remove the vial from the sample chamber, **empty the vial leaving a view drops in.**
5. Add **one DPD No. 1 tablet** straight from the foil to the water sample and crush the tablet using a clean stirring rod.
6. Add water sample to the 10 ml mark.
7. Close the vial tightly with the cap and swirl several times until the tablet is dissolved.
8. Place the vial in the sample chamber making sure that the X marks are aligned.

Zero accepted  
prepare Test  
press TEST

9. Press **TEST** key.

The result is shown in the display in mg/l Iodine.

## 1.1 Methods

**Notes:**

1. Oxidizing reagents, such as Chlorine, Bromine, etc. interfere as they react in the same way as Iodine.

<b>Reagent / Accessories</b>	<b>Form of reagent/Quantity</b>	<b>Order-No.</b>
DPD No. 1	Tablet / 100	511050BT

## 1.1 Methods

2 2 0

### Iron with Tablet

0.02 – 1 mg/l Fe

Determination of total dissolved Iron  $\text{Fe}^{2+}$  and  $\text{Fe}^{3+}$  \*

2 2 2

### Iron with Vario Powder Pack

0.02 – 3 mg/l Fe

Determination of all dissolved iron and most undissolved forms of iron. \*

2 2 3

### Iron, total with Vario Powder Pack

0.02 – 1.8 mg/l Fe

Determination of all dissolved iron and most undissolved forms of iron; most undissolved iron oxides are recovered by the reagent. \*

2 2 4

### Iron, total (Fe in Mo) with Vario Powder Pack

0.01 – 1.80 mg/l Fe

Determination of all dissolved iron and unsolved iron in the presence of high molybdate concentrations

2 2 5

### Iron LR with Liquid Reagent

0.03 – 2 mg/l Fe

Determination of total soluble Iron  $\text{Fe}^{2+}$ / $\text{Fe}^{3+}$  in presence of complexing agent (e.g. Molybdate) \*

2 2 6

### Iron LR 2 with Liquid reagent

0.03 – 2 mg/l  $\text{Fe}^{2+}$  and  $\text{Fe}^{3+}$

Determination of total soluble Iron  $\text{Fe}^{2+}$  and  $\text{Fe}^{3+}$  in presence of complexing agent (e.g. Molybdate) \*



## 1.1 Methods

2 2 7

### Iron HR with Liquid reagent

0.1 – 10 mg/l Fe

Determination of total soluble Iron  $\text{Fe}^{2+/3+}$  in presence of complexing agent (e.g. Molybdate) \*

\*This information refers to analysis of the water sample without digestion.

Further information can be found in the method notes.

#### Notes (Methods 220, 222, 223):

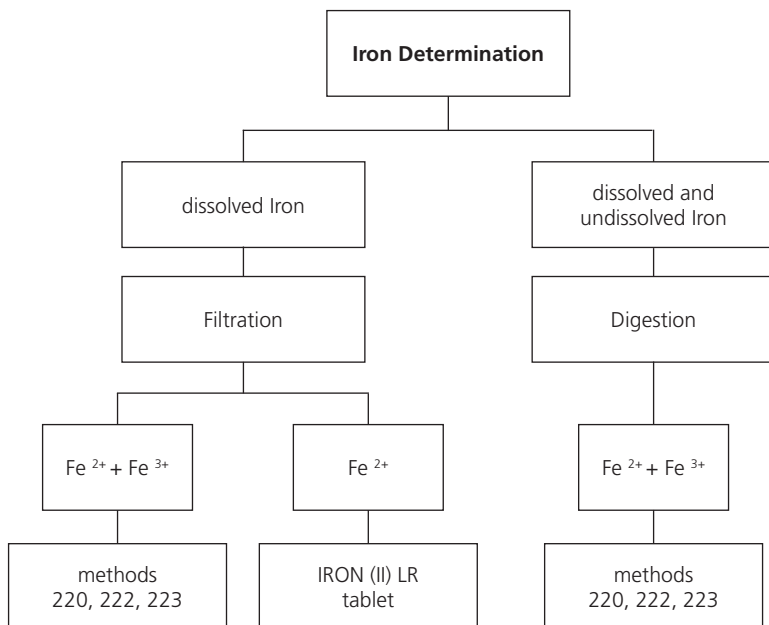

**Digestion procedure** for the determination of total dissolved and undissolved iron.

1. Add 1 ml of concentrated sulfuric acid to 100 ml water sample. Heat and boil for 10 minutes or until all particles are dissolved. After cooling down, the sample is set to a pH-value of 3 to 6 by using ammonia solution. Refill with deionised water to the previous volume of 100 ml and mix well. 10 ml of this pre-treated solution is used for the following analysis. Perform as described by the selected test method.
2. Water which has been treated with organic compounds like corrosion inhibitors must be oxidised where necessary to break down the iron. Therefore add 1 ml concentrated sulfuric acid and 1 ml concentrated nitric acid to 100 ml water sample and boil to approx. half volume. After cooling down, proceed as described above.

## 1.1 Methods

2 2 0

### Iron (Note 1) with Tablet

0.02 – 1 mg/l Fe



prepare Zero  
press ZERO

1. Fill a clean vial (24 mm Ø) with **10 ml of the water sample**, close tightly with the cap.
2. Place the vial in the sample chamber making sure that the  $\Sigma$  marks are aligned.
3. Press **ZERO** key.
4. Remove the vial from the sample chamber.
5. Add **one IRON LR tablet** straight from the foil to the water sample and crush the tablet using a clean stirring rod.
6. Close the vial tightly with the cap and swirl several times until the tablet is dissolved.
7. Place the vial in the sample chamber making sure that the  $\Sigma$  marks are aligned.

Zero accepted  
prepare Test  
press TEST

Countdown  
5:00

8. Press **TEST** key.  
Wait for a **reaction period of 5 minutes**.

After the reaction period is finished the measurement starts automatically.

The result is shown in the display in mg/l Iron ( $\text{Fe}^{2+3+}$ ).

## 1.1 Methods

### Notes:

1. This method determines the total dissolved Iron as Fe<sup>2+</sup> and Fe<sup>3+</sup>.
2. The IRON (II) LR tablet is used for differentiation – as described above – instead of the IRON LR tablet.  
$$\text{Fe}^{3+} = \text{Fe}^{2+/3+} - \text{Fe}^{2+}$$
3. For the determination of total dissolved and undissolved iron digestion is required.  
An example is described on page 145.

Reagent / Accessories	Form of reagent/Quantity	Order-No.
IRON LR	Tablet / 100	515370BT
IRON (II) LR	Tablette / 100	515420BT

## 1.1 Methods



### Iron (Note 1) with Vario Powder Pack

0.02 – 3 mg/l Fe



Ø 24 mm

prepare Zero  
press ZERO

1. Fill a clean vial (24 mm Ø) with **10 ml of the water sample**, close tightly with the cap.
2. Place the vial in the sample chamber making sure that the marks  $\times$  are aligned.
3. Press **ZERO** key.
4. Remove the vial from the sample chamber.

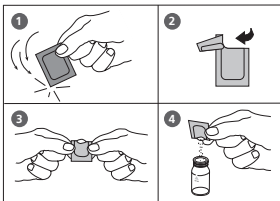

5. Add the contents of **one Vario Ferro F10 Powder Pack** straight from the foil to the water sample.
6. Close the vial tightly with the cap and swirl several times to mix the contents (Note 4).
7. Place the vial in the sample chamber making sure that the  $\times$  marks are aligned.

Zero accepted  
prepare Test  
press TEST

Countdown  
3:00

8. Press **TEST** key.  
Wait for a **reaction period of 3 minutes (Note 5)**.

After the reaction period is finished the measurement starts automatically.

The result is shown in the display in mg/l Iron.

## 1.1 Methods

### Notes:

1. The reagent reacts with all dissolved iron and most undissolved forms of iron in the water sample.
2. Iron oxide requires prior digestion: use mild, vigorous or Digesdahl digestion (e.g. for digestion with acid see page 145).
3. Very strong alkaline or acidic water samples must be adjusted to a pH value between 3 and 5 before analysis.
4. Accuracy is not affected by undissolved powder.
5. Water samples containing visible rust should be allowed to react for at least five minutes.

Reagent / Accessories	Form of reagent/Quantity	Order-No.
VARIO Ferro F10	Powder Pack / 100	530560

## 1.1 Methods



### Iron, total (TPTZ, Note 1) with Vario Powder Pack

0.02 – 1.8 mg/l Fe



Use two clean vials (24 mm Ø) and mark one as blank for zeroing.

1. Fill a clean vial with **10 ml deionised water** (this is the blank).

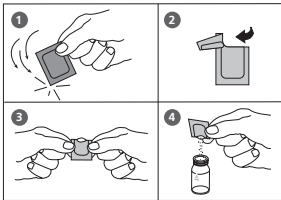

2. Fill the second clean vial with **10 ml of the water sample** (this is the sample).

3. Add the contents of **one Vario IRON TPTZ F10 Powder Pack** straight from the foil into each vial.

4. Close the vials tightly with the caps and swirl several times to mix the contents.

Countdown  
3:00  
start: ↴

5. Press **[↴]** key.  
Wait for a reaction **period of 3 minutes**.

After the reaction period is finished proceed as follows:

6. Place the vial (the blank) in the sample chamber making sure that the  $\Sigma$  marks are aligned.

prepare Zero  
press ZERO

7. Press **ZERO** key.

8. Remove the vial from the sample chamber.

9. Place the vial (the sample) in the sample chamber making sure that the  $\Sigma$  marks are aligned.

Zero accepted  
prepare Test  
press TEST

10. Press **TEST** key.

The result is shown in the display in mg/l Iron.

## 1.1 Methods

### Notes:

1. For determination of total Iron digestion is required.  
TPTZ reagent recovers most insoluble iron oxides without digestion.
2. Rinse all glassware with 1:1 Hydrochloric acid solution first and then rinse with deionised water to remove iron deposits that can cause slightly high results.
3. Strong alkaline or acidic water samples must be adjusted between pH 3 and pH 8 before the reagent is added (use 0.5 mol/l Sulfuric acid resp. 1 mol/l Sodium hydroxide).
4. Interferences:

When interferences occur, colour development is inhibited or a precipitate is formed.

The values below refer to a standard with an iron concentration of 0.5 mg/l.

The following substances do not interfere when present up to the levels given:

Substance	no interference to
Cadmium	4.0 mg/l
Chromium <sup>(3+)</sup>	0.25 mg/l
Chromium <sup>(6+)</sup>	1.2 mg/l
Cobalt	0.05 mg/l
Copper	0.6 mg/l
Cyanide	2.8 mg/l
Manganese	50 mg/l
Mercury	0.4 mg/l
Molybdenum	4.0 mg/l
Nickel	1.0 mg/l
Nitrite Ion	0.8 mg/l

Reagent / Accessories	Form of reagent/Quantity	Order-No.
VARIO IRON TPTZ F10	Powder Pack / 100	530550

## 1.1 Methods

2 2 4

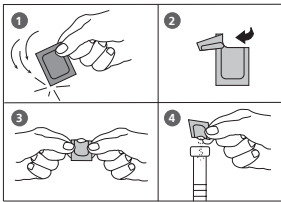
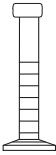

Ø 24 mm

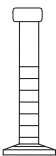

### Iron, total (Fe in Mo) in the presence of Molybdate with Vario Powder Pack

0.01 – 1.80 mg/l Fe

1. Fill a clean Mixing Cylinder (50 ml) with **50 ml of the water sample**.
2. Add the contents of **one Vario (Fe in Mo) Rgt 1 Powder Pack** straight from the foil into the water sample (50 ml).
3. Close the Mixing Cylinder tightly with a stopper and invert several times to dissolve the powder.
4. Use two clean vials (24 mm Ø) and mark one as blank for zeroing.
5. Add **10 ml of the prepared water sample** to the vial (this is **the blank**).
6. Close the blank tightly with the cap.
7. Fill a clean Mixing Cylinder (25 ml) with **25 ml of the prepared water sample**.
8. Add the contents of **one Vario (Fe in Mo) Rgt 2 Powder Pack** straight from the foil into the prepared **water sample** (25 ml).
9. Close the Mixing Cylinder tightly with a stopper and invert several times to dissolve the powder (note 5).
10. Press **[↵]** key.  
**Wait for a reaction period of 3 minutes.**
11. After the reaction period is finished proceed as follows:  
Fill the second prepared vial (point 4) with 10 ml of the sample. This is **the sample**.
12. Place **the blank** in the sample chamber making sure that the **X** marks are aligned.

Count-Down 1

3:00

Start: ↵



## 1.1 Methods

**prepare Zero  
press ZERO**

13. Press **ZERO** key.
14. Remove the vial from the sample chamber.
15. Place **the sample** in the sample chamber making sure that the  $\Sigma$  marks are aligned.

**Zero accepted  
prepare Test  
press TEST**

15. Press **TEST** key.

The result is shown in the display in mg/l Fe.

### Notes:

1. Rinse all glassware with detergent, followed by tap water. Rinse again with 1:1 Hydrochloric acid solution and deionized water. These steps will remove deposits that can cause slightly high results.
2. Take the sample reading immediately after the instrument zero, If the sample contains 100 mg/l or more Molybdate ( $\text{MoO}_4^{2-}$ ).
3. For more accurate results, a reagent blank value for each new lot of reagent is advisable. Follow the described procedure using deionized water instead of the sample. Subtract the obtained reading value from the final results.
4. Interference pH: A sample pH of less than 3 or more than 4 after addition of reagent, may inhibit colour formation, as the developed colour fades too quickly or results in turbidity. Adjust the sample pH to between 3 and 5 in the graduated cylinder before the addition of reagent:
  - Add by drops an applicable amount of Iron-free acid or base eg. 1 N Sulfuric acid solution or 1 N Sodium hydroxide solution.
  - If necessary make a volume correction if significant volumes of acid or base are used.
5. If Iron is present a blue colour develops. A small amount of undissolved reagent does not have an affect on the results of the test.

### Sample collection and storage:

- Collect samples in clean glass or plastic bottles. These should have been cleaned with 6 N (1:1) Hydrochloric acid and rinsed with deionised water.
- To preserve samples for later analysis, adjust the sample pH to less than 2 with concentrated Hydrochloric acid by adding about 2 ml per liter. If the sample is tested immediately this acid addition is not necessary.
- If the dissolved Iron is required, filter the sample through a 0.45-micron filter or equivalent medium immediately after collection and before acidification.
- The preserved samples should be kept at room temperature for a maximum of 6 months.
- Adjust the pH to 3 – 5 by adding 5 N Sodium hydroxide solution before analysis. Do not exceed pH 5 as Iron might precipitates.
- The test result needs to be corrected for the dilution caused by the volume additions.

Reagent / Accessories	Form of reagent/Quantity	Order-No.
<b>Set</b> Vario (Fe in Mo) Rgt 1 Vario (Fe in Mo) Rgt 2	Powder Pack / 100 Powder Pack / 100	<b>536010</b>

## 1.1 Methods

2

2

5

### Iron LR with Liquid reagent

0.03 – 2 mg/l Fe<sup>2+/3+</sup>



Ø 24 mm

This test is suitable for determining total soluble iron. The sample should be pre-filtered using a 0.45 µm membrane if total dissolved iron is required. Particulate or suspended iron will otherwise add to the result.

1. Fill a clean vial (24 mm Ø) with **10 ml of the water sample**, close tightly with the cap.
2. Place the vial in the sample chamber making sure that the marks X are aligned.

prepare Zero  
press ZERO

3. Press **ZERO** key.
4. Remove the vial from the sample chamber.
5. Fill the vial with drops of the same size by holding the bottle vertically and squeeze slowly:

**10 drops KS61 (Ferrozine/Thioglycolate)**

6. Close the vial tightly with the cap and swirl several times to mix the contents.
7. Place the vial in the sample chamber making sure that the marks X are aligned.

Zero accepted  
prepare Test  
press TEST

8. Press **TEST** key.

Wait for a reaction **period of 5 minutes** (note 1).

After the reaction period is finished the measurement starts automatically.

Countdown  
5:00

The result is shown in the display in mg/l Iron.

## 1.1 Methods

### Notes:

1. Complexed iron may be measured by increasing the development period until no further colour development is seen. Very strongly complexed iron may not be included in the measured iron. In this case the complexing agent must be destroyed by oxidation with acid/persulphate followed by neutralisation to pH 6–9. Follow the procedure on page 156.
2. For total iron (suspended and dissolved), boil sample with acid/persulphate. Neutralise back to pH 6–9 making back up to original volume with distilled or deionised water. Follow the procedure on page 156.
3. When using KS61 (Ferrozine/Thioglycolate), high levels of molybdate will produce an intense yellow colour.  
In this case a reagent blank is required:
  - Use two clean vials (24 mm Ø).
  - Mark one as blank for zeroing.
  - Fill a clean vial (24 mm Ø) with **10 ml of the water sample** (blank).
  - Add **10 drops KS63 (Thioglycolate)**.
  - Close the vial tightly with the cap and swirl gently several times.
  - Place the blank in the sample chamber making sure that the marks  $\bar{X}$  are aligned.
  - Press **ZERO** key.
  - Remove the vial from the sample chamber.
  - Fill a second clean 24 mm vial with **10 ml water sample** (this is the sample).
  - Follow the procedure as described on page 154, point 5.

Reagent / Accessories	Form of reagent/Quantity	Order-No.
KS61 (Ferrozine/ Thioglycolate)	Liquid reagent / 65 ml	56L006165
KS63 (Thioglycolate Reagent)	Liquid reagent / 65 ml	56L006365
KP962 (Ammonium Persulphate Powder)	Powder	56P096240
KS135 (Phenolphthalein Substitute Indikator)	Liquid reagent / 65 ml	56L013565
KS144 (Calcium Hardness Puffer)	Liquid reagent / 65 ml	56L014465
Spoon	0,5 g Spoon	385340

## 1.1 Methods

2

2

5

### Iron, total LR with Liquid reagent

0.03 – 2 mg/l Fe<sup>2+/3+</sup>



Ø 24 mm

**Digestion procedure** for the determination of total iron.

Total iron consists of soluble, complexed and suspended iron. Do not filter the sample but ensure the sample is homogeneous by vigorously shaking immediately prior to sampling. For Total Soluble (including all complexed) filtration will be necessary.

This procedure requires equipment and reagents not included in the standard test pack supplied.

1. Fill a clean 100-ml-Erlenmeyer flask with **50 ml homogenized sample**.
2. Add **5 ml 1:1 Hydrochloric acid** and **one spoon KP962 (Ammonium Persulphate Powder)**.
3. Boil for **20 minutes**, maintaining the sample volume above 25 ml with deionised water.
4. Cool the sample to room temperature.
5. Fill the vial with drops of the same size by holding the bottle vertically and squeeze slowly:  
**1 drop KS135 (Phenolphthalein Substitute Indicator)**
6. Add drops of **KS144 (Calcium Hardness Buffer)**, one drop at a time **with mixing**, until a pink/red colour just appears.
7. Fill the sample up to 50ml with deionised water.
8. Fill a clean vial (24 mm Ø) with **10 ml of the water sample**, close tightly with the cap.

## 1.1 Methods

prepare Zero  
press ZERO

9. Place the vial in the sample chamber making sure that the marks  $\times$  are aligned.

10. Press **ZERO** key.

11. Remove the vial from the sample chamber and empty the vial.

12. Add **10 ml prepared water sample to the same vial.**

13. Fill the vial with drops of the same size by holding the bottle vertically and squeeze slowly:

**10 drops KS61 (Ferrozine/Thioglycolate)**

14. Close the vial tightly with the cap and swirl several times to mix the contents.

15. Place the vial in the sample chamber making sure that the marks  $\times$  are aligned.

Zero accepted  
prepare Test  
press TEST

16. Press **TEST** key.

Wait for a reaction **period of 5 minutes** (note 1, page 155).

After the reaction period is finished the measurement starts automatically.

The result is shown in the display in mg/l total iron or, if a filtered sample was used, in mg/l total soluble iron.

## 1.1 Methods

2

2

6

### Iron LR 2 with Liquid reagent

0.03 – 2 mg/l Fe<sup>2+</sup> and Fe<sup>3+</sup>



Ø 24 mm

This test is suitable for determining total soluble iron and differentiating between the ferrous and ferric state. The sample should be pre-filtered using a 0.45 µm membrane if total dissolved iron is required. Particulate or suspended iron will otherwise add to the result.

1. Fill a clean vial (24 mm Ø) with **10 ml of the water sample**, close tightly with the cap.
2. Place the vial in the sample chamber making sure that the marks X are aligned.
3. Press **ZERO** key.
4. Remove the vial from the sample chamber.
5. Fill the vial with drops of the same size by holding the bottle vertically and squeeze slowly:  
**10 drops KS60 (Acetate Buffer)**
6. Close the vial tightly with the cap and swirl several times to mix the contents.
7. Fill the vial with drops of the same size by holding the bottle vertically and squeeze slowly:  
**10 drops KS63 (Thioglycolate)** (note 1)
8. Close the vial tightly with the cap and swirl several times to mix the contents.
9. Fill the vial with drops of the same size by holding the bottle vertically and squeeze slowly:  
**10 drops KS65 (Ferrozine)**
10. Close the vial tightly with the cap and swirl several times to mix the contents.
11. Place the vial in the sample chamber making sure that the marks X are aligned.

prepare Zero  
press ZERO

## 1.1 Methods

Zero accepted  
prepare Test  
press TEST

Countdown  
5:00

- Press **TEST** key.  
Wait for a reaction **period of 5 minutes** (note 2).  
After the reaction period is finished the measurement starts automatically.

The result is shown in the display in mg/l  $\text{Fe}^{2+/3+}$  or, if step 7 is omitted,  $\text{Fe}^{2+}$ .

$$\text{Fe}^{3+} = \text{Fe}^{2+/3+} - \text{Fe}^{2+}$$

### Notes:

- For soluble iron  $\text{Fe}^{2+}$  omit step 7.
- Complexed iron may be measured by increasing the development period until no further colour development is seen. Very strongly complexed iron may not be included in the measured iron. In this case the complexing agent must be destroyed by oxidation with acid/persulphate followed by neutralisation to pH 6–9.  
Follow the procedure on page 160.
- For total iron (suspended and dissolved), boil sample with acid/persulphate. Neutralise back to pH 6–9 making back up to original volume with distilled or deionised water.  
Follow the procedure on page 160.

- When using KS63 (Thioglycolate), high levels of molybdate will produce an intense yellow colour.

In this case a reagent blank is required:

- Use two clean vials (24 mm Ø).
- Mark one as blank for zeroing.
- Fill a clean vial (24 mm Ø) with **10 ml of the water sample** (blank).
- Add **10 drops KS63 (Thioglycolate)**.
- Close the vial tightly with the cap and swirl gently several times.
- Place the blank in the sample chamber making sure that the marks  $\times$  are aligned.
- Press **ZERO** key.
- Remove the vial from the sample chamber.
- Fill a second clean 24 mm vial with **10 ml water sample** (this is the sample).
- Follow the procedure as described on page 158, point 5.

Reagent / Accessories	Form of reagent/Quantity	Order-No.
KS60 – Acetate Buffer	Liquid reagent / 65 ml	56L006065
KS63 – Thioglycolate Reagent	Liquid reagent / 65 ml	56L006365
KS65 – Ferrozine Reagent	Liquid reagent / 65 ml	56L006565
KP962 (Ammonium Persulphate Powder)	Powder	56P096240
KS135 (Phenolphthalein Substitute Indikator)	Liquid reagent / 65 ml	56L013565
KS144 (Calcium Hardness Puffer)	Liquid reagent / 65 ml	56L014465
Spoon	0,5 g Spoon	385340

## 1.1 Methods

2

2

6

### Iron, total LR 2 with Liquid reagent

0.03 – 2 mg/l Fe<sup>2+/3+</sup>



**Digestion procedure** for the determination of total iron.

Total iron consists of soluble, complexed and suspended iron. Do not filter the sample but ensure the sample is homogeneous by vigorously shaking immediately prior to sampling. For Total Soluble (including all complexed) filtration will be necessary.

This procedure requires equipment and reagents not included in the standard test pack supplied.

1. Fill a clean 100-ml-Erlenmeyer flask with **50 ml homogenized sample**.
2. Add **5 ml 1:1 Hydrochloric acid** and **one spoon KP962 (Ammonium Persulphate Powder)**.
3. Boil for **20 minutes**, maintaining the sample volume above 25 ml with deionised water.
4. Cool the sample to room temperature.
5. Fill the vial with drops of the same size by holding the bottle vertically and squeeze slowly:  
**1 drop KS135 (Phenolphthalein Substitute Indicator)**
6. Add drops of **KS144 (Calcium Hardness Buffer)**, one drop at a time **with mixing**, until a pink/red colour just appears.
7. Fill the sample up to 50ml with deionised water.
8. Fill a clean vial (24 mm Ø) with **10 ml of the water sample**, close tightly with the cap.
9. Place the vial in the sample chamber making sure that the marks **X** are aligned.



## 1.1 Methods

prepare Zero  
press ZERO

10. Press **ZERO** key.
11. Remove the vial from the sample chamber and empty the vial.
12. Add **10 ml prepared water sample to the same vial.**
13. Fill the vial with drops of the same size by holding the bottle vertically and squeeze slowly:  
**10 drops KS60 (Acetate Buffer)**
14. Close the vial tightly with the cap and swirl several times to mix the contents.
15. Fill the vial with drops of the same size by holding the bottle vertically and squeeze slowly:  
**10 drops KS63 (Thioglycolate)** (note 1, page 158)
16. Close the vial tightly with the cap and swirl several times to mix the contents.
17. Fill the vial with drops of the same size by holding the bottle vertically and squeeze slowly:  
**10 drops KS65 (Ferrozine)**
18. Close the vial tightly with the cap and swirl several times to mix the contents.
19. Place the vial in the sample chamber making sure that the marks  $\times$  are aligned.

Zero accepted  
prepare Test  
press TEST

Countdown  
5:00

20. Press **TEST** key.  
Wait for a reaction **period of 5 minutes** (note 2, page 159).  
After the reaction period is finished the measurement starts automatically.

The result is shown in the display in mg/l total iron or, if a filtered sample was used, in mg/l total soluble iron.

## 1.1 Methods



### Iron HR with Liquid reagent

0.1 – 10 mg/l Fe<sup>2+/3+</sup>



Ø 24 mm

This test is suitable for determining total soluble iron. The sample should be pre-filtered using a 0.45 µm membrane if total dissolved iron is required. Particulate or suspended iron will otherwise add to the result.

1. Fill a clean vial (24 mm Ø) with **10 ml of the water sample**, close tightly with the cap.
2. Place the vial in the sample chamber making sure that the marks X are aligned.

**prepare Zero  
press ZERO**

3. Press **ZERO** key.
4. Remove the vial from the sample chamber.
5. Fill the vial with drops of the same size by holding the bottle vertically and squeeze slowly:  
**10 drops KS63 (Thioglycolate)**
6. Close the vial tightly with the cap and swirl several times to mix the contents. Wait until purple coloration goes before continuing.
7. Fill the vial with drops of the same size by holding the bottle vertically and squeeze slowly:  
**10 drops KS160 (Total Hardness Buffer)**
8. Close the vial tightly with the cap and swirl several times to mix the contents.
9. Place the vial in the sample chamber making sure that the marks X are aligned.

## 1.1 Methods

Zero accepted  
prepare Test  
press TEST

Countdown  
15:00

10. Press **TEST** key.

Wait for a reaction **period of 15 minutes** (note 1).

After the reaction period is finished the measurement starts automatically.

The result is shown in the display in mg/l Iron.

### Notes:

1. Complexed iron may be measured by increasing the development period until no further colour development is seen. Very strongly complexed iron may not be included in the measured iron. In this case the complexing agent must be destroyed by oxidation with acid/persulphate followed by neutralisation to pH 6–9. Follow the procedure on page 164.
2. For total iron (suspended and dissolved), boil sample with acid/persulphate. Neutralise back to pH 6–9 making back up to original volume with distilled or deionised water. Follow the procedure on page 164.

Reagent / Accessories	Form of reagent/Quantity	Order-No.
KS160 – Total Hardness Buffer	Liquid reagent / 65 ml	56L016065
KS63 – Thioglycolate Reagent	Liquid reagent / 65 ml	56L006365
KP962 (Ammonium Persulphate Powder)	Pulver	56P096240
KS144 (Calcium Hardness Puffer)	Liquid reagent / 65 ml	56L014465
Spoon	0,5 g Spoon	385340

## 1.1 Methods

2

2

7

### Iron, total HR with Liquid reagent

0.1 – 10 mg/l Fe<sup>2+/3+</sup>



Ø 24 mm

**Digestion procedure** for the determination of total iron.

Total iron consists of soluble, complexed and suspended iron. Do not filter the sample but ensure the sample is homogeneous by vigorously shaking immediately prior to sampling. For Total Soluble (including all complexed) filtration will be necessary.

This procedure requires equipment and reagents not included in the standard test pack supplied.

1. Fill a clean 100-ml-Erlenmeyer flask with **50 ml homogenized sample**.
2. Add **5 ml 1:1 Hydrochloric acid** and **one spoon KP962 (Ammonium Persulphate Powder)**.
3. Boil for **20 minutes**, maintaining the sample volume above 25 ml with deionised water.
4. Cool the sample to room temperature.
5. Add drops of **KS144 (Calcium Hardness Buffer)**, two drop at a time **with mixing**, until a neutral or slightly alkaline solution is obtained. Test periodically with a pH meter or dip-papers (take care not to add excessive buffer).
6. Fill the sample up to 50ml with deionised water.
7. Fill a clean vial (24 mm Ø) with **10 ml of the water sample**, close tightly with the cap.
8. Place the vial in the sample chamber making sure that the marks **X** are aligned.

## 1.1 Methods

prepare Zero  
press ZERO

9. Press **ZERO** key.
  
10. Remove the vial from the sample chamber and empty the vial.
  
11. Add **10 ml prepared water sample to the same vial.**
  
12. Fill the vial with drops of the same size by holding the bottle vertically and squeeze slowly:  
**10 drops KS63 (Thioglycolate)**
  
13. Close the vial tightly with the cap and swirl several times to mix the contents.
  
14. Fill the vial with drops of the same size by holding the bottle vertically and squeeze slowly:  
**10 drops KS160 (Total Hardness Buffer)**
  
15. Close the vial tightly with the cap and swirl several times to mix the contents.
  
16. Place the vial in the sample chamber making sure that the marks  $\times$  are aligned.

Zero accepted  
prepare Test  
press TEST

Countdown  
15:00

17. Press **TEST** key.  
  
Wait for a reaction **period of 15 minutes** (note 1, page 163).  
  
After the reaction period is finished the measurement starts automatically.

The result is shown in the display in mg/l total iron or, if a filtered sample was used, in mg/l total soluble iron.

## 1.1 Methods

2 4 0

### Manganese with Tablet

0.2 – 4 mg/l Mn



prepare Zero  
press ZERO

1. Fill a clean vial (24 mm Ø) with **10 ml of the water sample**, close tightly with the cap.
2. Place the vial in the sample chamber making sure that the X marks are aligned.

3. Press **ZERO** key.

4. Remove the vial from the sample chamber.

5. Add **one MANGANESE LR 1 tablet** straight from the foil to the water sample and crush the tablet using a clean stirring rod and dissolve the tablet.

6. Add **one MANGANESE LR 2 tablet** straight from the foil to the same water sample and crush the tablet using a clean stirring rod.

7. Close the vial tightly with the cap and swirl several times until the tablets are dissolved.

8. Place the vial in the sample chamber making sure that the marks X are aligned.

9. Press **TEST** key.

Wait for a **reaction period of 5 minutes**.

After the reaction period is finished the measurement starts automatically.

The result is shown in the display in mg/l Manganese.

Zero accepted  
prepare Test  
press TEST

Countdown  
5:00

## 1.1 Methods

**Note:**

1. ▲ Mn  
    MnO<sub>4</sub>  
    ▼ KMnO<sub>4</sub>

Reagent / Accessories	Form of reagent/Quantity	Order-No.
<b>Set</b> MANGANESE LR No. 1 / No. 2	Tablet / per 100 inclusive stirring rod	517621BT
MANGANESE LR No. 1	Tablet / 100	516080BT
MANGANESE LR No. 2	Tablet / 100	516090BT

## 1.1 Methods

2 4 2

### Manganese LR with Vario Powder Pack

0.01 – 0.7 mg/l Mn



Ø 24 mm

Use two clean vials (24 mm Ø) and mark one as blank for zeroing (Note 1).

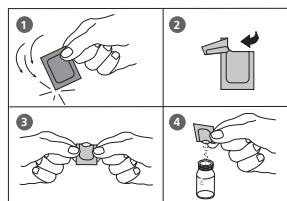

1. Fill a clean vial with **10 ml of deionised water** (this is the blank).
2. Fill the second clean vial with **10 ml of the water sample** (this is the sample).
3. Add the contents of **one Vario Ascorbic Acid Powder Pack** straight from the foil into each vial (Note 2).
4. Close the vials tightly with the caps and swirl several times to mix the contents.
5. Fill each vial with drops of the same size by holding the bottle vertically and squeeze slowly (Note 3):  
**15 drops of Alkaline Cyanide reagent solution**
6. Close the vials tightly with the caps and swirl several times to mix the contents.
7. Fill each vial with drops of the same size by holding the bottle vertically and squeeze slowly:  
**21 drops of PAN Indicator solution**
8. Close the vials tightly with the caps and swirl several times to mix the contents.
9. Press **[↵]** key.  
Wait for a **reaction period of 2 minutes** (Note 4).

Countdown 1  
2:00  
start: ↵

prepare Zero  
press ZERO

Zero accepted  
prepare Test  
press TEST

- After the reaction period is finished proceed as follows:
10. Place the vial (the blank) in the sample chamber making sure that the marks are  $\times$  aligned.
  11. Press **ZERO** key.
  12. Remove the vial from the sample chamber.
  13. Place the vial (the sample) in the sample chamber making sure that the marks are  $\times$  aligned.
  14. Press **TEST** key.
- The result is shown in the display in mg/l Manganese.



## 1.1 Methods

### Notes:

1. Rinse all glassware with 1:1 Nitric acid solution first and then rinse with deionised water.
2. Water samples that contain more than 300 mg/l CaCO<sub>3</sub> hardness: after adding the Vario Ascorbic Acid powder pack add additionally 10 drops of Rochelle Salt Solution.
3. After addition of the reagent solution "Alkaline-Cyanide" a cloudy or turbid solution may form in some water samples. The turbidity should disappear after point 7.
4. Water samples containing more than 5 mg/l iron should be allowed to react for at least 10 minutes.
5. Conversion:  
 $\text{mg/l MnO}_4 = \text{mg/l Mn} \times 2.17$
6. ▲ Mn  
MnO<sub>4</sub>  
▼ KMnO<sub>4</sub>

Reagent / Accessories	Form of reagent/Quantity	Order-No.
<b>Set</b> VARIO Ascorbic Acid VARIO Alkaline-Cyanide VARIO PAN Indicator	Powder Pack / 100 Liquid reagent / 60 ml Liquid reagent / 60 ml	535090
VARIO Rochelle Salzlösung	30 ml	530640

## 1.1 Methods

2 4 3

### Manganese HR with Vario Powder Pack

0.1 – 18 mg/l Mn



prepare Zero  
press ZERO

1. Fill a clean vial (24 mm Ø) with **10 ml of the water sample**, close tightly with the cap.
2. Place the vial in the sample chamber making sure that the  $\Sigma$  marks are aligned.
3. Press **ZERO** key.
4. Remove the vial from the sample chamber.

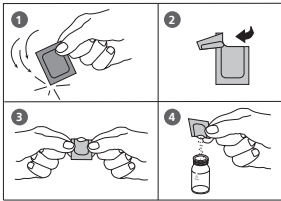

5. Add the contents of **one Vario Manganese Citrate Buffer F10 Powder Pack** straight from the foil to the water sample.
6. Close the vial tightly with the cap and swirl several times to mix the contents.
7. Add the contents of **one VARIO Sodium Periodate F10 Powder Pack** straight from the foil to the same water sample.
8. Close the vial tightly with the cap and swirl several times to mix the contents.
9. Place the vial in the sample chamber making sure that the  $\Sigma$  marks are aligned.
10. Press **TEST** key.

Zero accepted  
prepare Test  
press TEST

Countdown  
2:00

Wait for a **reaction period of 2 minutes**.

After the reaction period is finished the measurement starts automatically.

The result is shown in the display in mg/l Manganese.

## 1.1 Methods

### Notes:

1. This test is applicable for the determination of soluble Manganese in water and wastewater.
2. Highly buffered water samples or extreme pH values may exceed the buffering capacity of the reagents and requires sample pre-treatment.  
If samples were acidified for storing, adjust the pH between 4 and 5 with 5 mol/l (5 N) Sodium hydroxide before test. Do not exceed pH 5, as manganese may precipitate.
3. Interferences:

Interfering substance	Interference level
Calcium	greater than 700 mg/l
Chloride	greater than 70 000 mg/l
Iron	greater than 5 mg/l
Magnesium	greater than 100 000 mg/l

4. ▲ Mn  
MnO<sub>4</sub>  
▼ KMnO<sub>4</sub>

Reagent / Accessories	Form of reagent/Quantity	Order-No.
<b>Set</b> VARIO Manganese Citrate Buffer F10 VARIO Sodiumperiodate F10	Powder Pack / 100 Powder Pack / 100	535100

## 1.1 Methods

2

4

5

### Manganese with Liquid reagent

0.05 – 5 mg/l Mn



Ø 24 mm

prepare Zero  
press ZERO

1. Fill a clean vial (24 mm Ø) with **10 ml of the water sample**, close tightly with the cap.
2. Place the vial in the sample chamber making sure that the X marks are aligned.
3. Press **ZERO** key.
4. Remove the vial from the sample chamber.
5. Fill the vial with drops of the same size by holding the bottle vertically and squeeze slowly:  
**10 drops KS265 (Manganese Reagent A)**
6. Close the vial tightly with the cap and swirl several times to mix the contents.
7. Fill the vial with drops of the same size by holding the bottle vertically and squeeze slowly:  
**10 drops KS266 (Manganese Reagent B)**
8. Close the vial tightly with the cap and swirl several times to mix the contents.
9. Fill the vial with drops of the same size by holding the bottle vertically and squeeze slowly:  
**10 drops KS304 (Manganese Reagent C)**
10. Close the vial tightly with the cap and swirl several times to mix the contents.

## 1.1 Methods

Zero accepted  
prepare Test  
press TEST

Countdown  
3:00

11. Place the vial in the sample chamber making sure that the marks  $\times$  are aligned.

12. Press **TEST** key.

Wait for a **reaction period of 3 minutes**.

After the reaction period is finished the measurement starts automatically.

The result is shown in the display in mg/l Manganese.

### Notes:

1. The following substances interfere with this test:

- Calcium > 500mg/l
- Sodium > 500mg/l
- Nickel > 0.5 mg/l
- Iron > 5 mg/l
- Chromium > 5 mg/l

Reagent / Accessories	Form of reagent/Quantity	Order-No.
KS265 – Manganese Reagent A	Liquid reagent / 30 ml	56L026530
KS266 – Manganese Reagent B	Liquid reagent / 30 ml	56L026630
KS304 – Manganese Reagent C	Liquid reagent / 30 ml	56L030430

## 1.1 Methods

2 5 0

### Molybdate with Tablet

1 – 50 mg/l  $\text{MoO}_4$  / 0.6 – 30 mg/l Mo



prepare Zero  
press ZERO

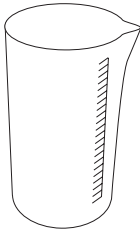

1. Fill a clean vial (24 mm Ø) with **10 ml of the water sample**, close tightly with the cap.
2. Place the vial in the sample chamber making sure that the  $\Sigma$  marks are aligned.
3. Press **ZERO** key.
4. Remove the vial from the sample chamber and **empty the vial**.
5. Fill **20 ml of the water sample** in a 100 ml beaker.
6. Add **one MOLYBDATE HR No. 1 tablet** straight from the foil to the water sample and crush the tablet using a clean stirring rod.
7. Add **one MOLYBDATE HR No. 2 tablet** straight from the foil to the same water sample and crush the tablet using a clean stirring rod.
8. Dissolve the tablets using a clean stirring rod.
9. Rinse out the vial with the prepared water sample and then fill to the 10 ml mark.
10. Close the vial tightly with the cap.
11. Place the vial in the sample chamber making sure that the  $\Sigma$  marks are aligned.
12. Press **TEST** key.

Zero accepted  
prepare Test  
press TEST

The result is shown in the display in mg/l Molybdate / Molybdenum.

## 1.1 Methods

### Notes:

1. The tablets must be added in the correct sequence.
2. Under test conditions (pH 3.8 – 3.9) iron does not interfere nor do other metals at levels likely to be found in industrial water systems.
3. Conversions:  
 $\text{mg/l Mo} = \text{mg/l MoO}_4 \times 0.6$   
 $\text{mg/l Na}_2\text{MoO}_6 = \text{mg/l MoO}_4 \times 1.3$
4. ▲  $\text{MoO}_4$   
Mo  
▼  $\text{Na}_2\text{MoO}_4$

Reagent / Accessories	Form of reagent/Quantity	Order-No.
<b>Set</b> MOLYBDATE HR No. 1 / No. 2	Tablet / per 100 inclusive stirring rod	517631BT
MOLYBDATE HR No. 1	Tablet / 100	513060BT
MOLYBDATE HR No. 2	Tablet / 100	513070BT

## 1.1 Methods

2 5 1

### Molybdate / Molybdenum LR mit Vario Powder Pack

0.05 – 5.0 mg/l MoO<sub>4</sub> / 0.03 – 3 mg/l Mo

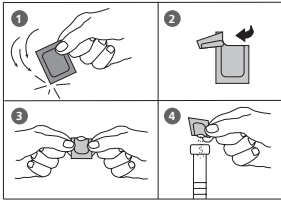
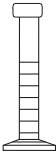

Ø 24 mm

1. Fill a clean Mixing Cylinder (25 ml) with **20 ml of the water sample**.
2. Add the contents of **one Vario Molybdenum 1 LR F20 Powder Pack** straight from the foil into the water sample (20 ml).
3. Close the Mixing Cylinder tightly with a stopper and swirl several times to dissolve the powder.
4. Use two clean vials (24 mm Ø) and mark one as blank for zeroing.
5. Fill each vial with 10 ml of pre prepared water sample.
6. Close the blank tightly with the cap.
7. Add **0,5 ml of Vario Molybdenum 2 LR solution** to the sample.
8. Close the vial tightly with the cap and invert several times to mix the contents.
9. Press **[↵]** key.  
**Wait for a reaction period of 2 minutes.**
10. After the reaction period is finished proceed as follows:
11. Place the blank in the sample chamber making sure that the **X** marks are aligned.

Count-Down 1

2:00

Start: ↵



## 1.1 Methods

**prepare Zero  
press ZERO**

12. Press **ZERO** key.
13. Remove the vial from the sample chamber.
14. Place the sample in the sample chamber making sure that the  $\bar{X}$  marks are aligned.

**Zero accepted  
prepare Test  
press TEST**

15. Press **TEST** key.

The result is shown in the display in mg/l Molybdate / Molybdenum.

### Notes:

1. Strong alkaline or acidic water samples must be adjusted between pH 3 and pH 5 before the reagent is added (use 0.5 mol/l Sulfuric acid resp. 1 mol/l Sodium hydroxide).
2. Before using clean the vials with Hydrochloric acid (approx. 20%). Rinse thoroughly with deionised water.
3. ▲  $\text{MoO}_4$   
Mo  
▼  $\text{Na}_2\text{MoO}_4$

Reagent / Accessories	Form of reagent/Quantity	Order-No.
<b>Set</b> VARIO Molybdenum 1 LR F20 VARIO Molybdenum 2 LR	Powder Pack / 100 Liquid reagent / 50 ml	535450
Mixing Cylinder	25 ml	19802650

## 1.1 Methods

2 5 2

### Molybdate / Molybdenum HR with Vario Powder Pack

0.5 – 66 mg/l MoO<sub>4</sub> / 0.3 – 40 mg/l Mo



Ø 24 mm

prepare Zero  
press ZERO

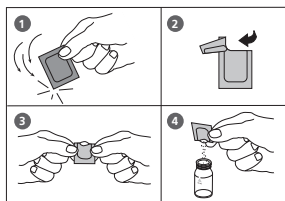

1. Fill a clean vial (24 mm Ø) with **10 ml of the water sample**, close tightly with the cap.
2. Place the vial in the sample chamber making sure that the  $\Sigma$  marks are aligned.
3. Press **ZERO** key.
4. Remove the vial from the sample chamber.
5. Add the contents of **one Vario Molybdenum HR 1 F10 Powder Pack** straight from the foil to the water sample.
6. Close the vial tightly with the cap and swirl several times to mix the contents.
7. Add the contents of **one Vario Molybdenum HR 2 F10 Powder Pack** straight from the foil to the same water sample.
8. Close the vial tightly with the cap and swirl several times to mix the contents.
9. Add the contents of **one Vario Molybdenum HR 3 F10 Powder Pack** straight from the foil to the same water sample.
10. Close the vial tightly with the cap and swirl several times to mix the contents.
11. Place the vial in the sample chamber making sure that the  $\Sigma$  marks are aligned.
12. Press **TEST** key.  
Wait for a **reaction period of 5 minutes**.

Zero accepted  
prepare Test  
press TEST

Countdown  
5:00

After the reaction period is finished the measurement starts automatically.

The result is shown in the display in mg/l Molybdate / Molybdenum.

## 1.1 Methods

### Notes:

1. Filter turbid water samples using filter paper and funnel before analysis.
2. Highly buffered water samples or extreme pH values should be adjusted to a pH of nearly 7 with 1 mol/l Nitric acid or 1 mol/l Sodium hydroxide.
3. Concentrations above 10 mg/l Cu causes too high test values if the reaction time of 5 minutes is increased. So it is very important to perform the test procedure as described.
4. Substances which may interfere when present in concentrations at:

Aluminium	50 mg/l
Chromium	1000 mg/l
Iron	50 mg/l
Nickel	50 mg/l
Nitrite	all levels

5. ▲ MoO<sub>4</sub>  
Mo  
▼ Na<sub>2</sub>MoO<sub>4</sub>

Reagent / Accessories	Form of reagent/Quantity	Order-No.
<b>Set</b> VARIO Molybdenum HR1 F10 VARIO Molybdenum HR2 F10 VARIO Molybdenum HR3 F10	Powder Pack / 100 Powder Pack / 100 Powder Pack / 100	535300

## 1.1 Methods

2

5

4

### Molybdate / Molybdenum HR with Liquid reagent

1 – 100 mg/l  $\text{MoO}_4$  / 0.6 – 60 mg/l Mo



Ø 24 mm

prepare Zero  
press ZERO

1. Fill a clean vial (24 mm Ø) with **10 ml of the water sample**, close tightly with the cap.
2. Place the vial in the sample chamber making sure that the  $\times$  marks are aligned.
3. Press **ZERO** key.

4. Remove the vial from the sample chamber.

5. Fill the vial with drops of the same size by holding the bottle vertically and squeeze slowly:

**10 drops KS63 (Thioglycolate)**

6. Close the vial tightly with the cap and swirl several times to mix the contents.
7. Place the vial in the sample chamber making sure that the  $\times$  marks are aligned.

Zero accepted  
prepare Test  
press TEST

Countdown  
5:00

8. Press **TEST** key.

Wait for a **reaction period of 5 minutes**.

After the reaction period is finished the measurement starts automatically.

The result is shown in the display in mg/l Molybdate / Molybdenum.

## 1.1 Methods

### Notes:

1. Perform tests on sample water taken directly from the system. Molybdate will be absorbed onto the walls of sample containers and give low results.
2. ▲  $\text{MoO}_4$   
Mo  
▼  $\text{Na}_2\text{MoO}_4$

Reagent / Accessories	Form of reagent/Quantity	Order-No.
KS63 – Thoiglycolate Reagent	Liquid reagent / 65 ml	56L006365

## 1.1 Methods

2

5

7

### Nickel with Tablet

0.1 – 10 mg/l Ni



Ø 24 mm

prepare Zero  
press ZERO

1. Fill a clean vial (24 mm Ø) with **10 ml of the water sample**, close tightly with the cap.
2. Place the vial in the sample chamber making sure that the marks  $\times$  are aligned.

3. Press **ZERO** key.

4. Remove the vial from the sample chamber.

5. Add **one NICKEL No. 1 tablet** straight from the foil to the 10 ml water sample, crush the tablet using a clean stirring rod and dissolve the tablet completely (Note 1).

6. Add **one NICKEL No. 2 tablet** straight from the foil to the same water sample and crush the tablet using a clean stirring rod.

7. Close the vial tightly with the cap and swirl several times until the tablet is dissolved.

8. Place the vial in the sample chamber making sure that the marks  $\times$  are aligned.

9. Press **TEST** key.  
Wait for a **reaction period of 2 minutes**.

Zero accepted  
prepare Test  
press TEST

Countdown  
2:00

After the reaction period is finished the measurement starts automatically.

The result is shown in the display in mg/l Ni.

## 1.1 Methods

### Notes:

1. If Iron is present in the sample, add one level spoonful of Nickel PT powder to the sample (after adding Nickel No. 1) and mix.
2. The presence of cobalt at 0.5 mg/l gives a positive response in the test.
3. The presence of higher levels of EDTA (at least 25 mg/l) complexes nickel and reduces response in the test. Complexing agents used in water treatment, such as polyphosphates, do not affect the results.

Reagent / Accessories	Form of reagent/Quantity	Order-No.
NICKEL No. 1	Tablet / 100	515630BT
NICKEL No. 2	Tablet / 100	515640BT

## 1.1 Methods

2

6

0

### Nitrate with Tablet and Powder

0.08 – 1 mg/l N



Ø 24 mm

prepare Zero  
press ZERO

1. Fill a clean vial (24 mm Ø) with **10 ml of the water sample**, close tightly with the cap.
2. Place the vial in the sample chamber making sure that the marks  $\times$  are aligned.
3. Press **ZERO** key.
4. Remove the vial from the sample chamber and empty the vial.
5. Fill the Nitrate test tube with **20 ml of the water sample**.
6. Add **1 level spoon of Nitrate Test powder**.
7. Close the tube tightly with the cap and swirl vigorously for one minute.
8. Add **one NITRATE TEST tablet** straight from the foil to the water sample.
9. Close the tube tightly with the cap and swirl vigorously for one minute.
10. Stand the tube upright and after the reducing agent has settled to the bottom, gently invert it three to four times so as to complete the flocculation of the reducing agent. Then let the tube stand for a further 2 minutes. Open the tube and wipe around the top of the tube with a clean tissue to remove any residuals of the reducing agent.
11. Carefully decant 10 ml of the treated solution into the vial (24 mm Ø) used for zeroing, ensuring that no reducing agent is carried over.



## 1.1 Methods

12. Add **one NITRITE LR tablet** straight from the foil to the water sample and crush the tablet using a clean stirring rod.
13. Close the vial tightly with the cap and swirl several times until the tablet is dissolved.
14. Place the vial in the sample chamber making sure that the  $\Sigma$  marks are aligned.
15. Press **TEST** key.

**Zero accepted  
prepare Test  
press TEST**

**Countdown  
10:00**

Wait for a **reaction period of 10 minutes**.

After the reaction period is finished the measurement starts automatically.

The result is shown in the display in mg/l Nitrate.

### Notes:

1. If Nitrite is present in the sample as well as nitrate, it will react with the NITRITE LR-tablet, leading to a high result. For correction, carry out a nitrite determination using method 270 in  $\text{NO}_2\text{-N}$  and subtract the result from the nitrate reading in  $\text{NO}_3\text{-N}$  to give the corrected result.
2. Concentration of nitrate nitrogen above 1 mg/l (e.g. 50 mg/l) lead to an apricot colour instead of the reddish pink solution after the reaction time of 10 minutes. This colour cannot be correctly measured by the photometer. The result displayed does not show the concentration of nitrate nitrogen. The range of the test can be extended by first diluting the water sample with deionised water. One standard method is to dilute 1.0 ml of sample up to 100 ml (dilution factor of 100). The subsequent result of the test must then be multiplied by the dilution factor.
3. The following ions can produce interference as under the reaction conditions they can cause precipitation : antimony(III), iron(III), lead, mercury(I), silver, chloroplatinate, metavanadate and bismuth. Copper(II) ions may give a low result as they accelerate the decomposition of the diazonium salt.  
It is improbable in practice that these interfering ions will occur in such high concentrations that they cause significant errors.

Reagent / Accessories	Form of reagent/Quantity	Order-No.
NITRATE TEST	Powder 15 g	465230
NITRATE TEST	Tablet / 100	502810
NITRITE LR	Tablet / 100	512310BT
Nitrate test tube		366220

## 1.1 Methods

2

6

5

### Nitrate with Tube Test

1 – 30 mg/l N



Insert the adapter for 16 mm Ø vials.

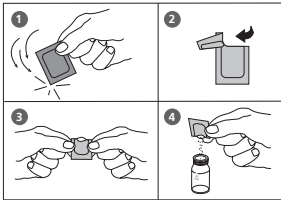

1. Open one white capped reaction vial and add **1 ml deionised water** (this is the blank).
2. Open another white capped reaction vial and add **1 ml of the water sample** (this is the sample).
3. Add the contents of **one Vario Nitrate Chromotropic Powder Pack** straight from the foil into each vial.
4. Close the vials tightly with the caps and and invert gently several times to mix the contents. **(CAUTION: The vials will become hot during mixing!)**

Countdown 1  
5:00  
start: ↵

5. Press [↵] key.  
Wait for a **reaction period of 5 minutes**.

After the reaction period is finished proceed as follows:

6. Place the vial (the blank) in the sample chamber making sure that the marks are  $\Delta$  aligned.
7. Press **ZERO** key.
8. Remove the vial from the sample chamber.
9. Place the vial (the sample) in the sample chamber making sure that the marks are  $\Delta$  aligned.
10. Press **TEST** key.

prepare Zero  
press ZERO

Zero accepted  
prepare Test  
press TEST

The result is shown in the display in mg/l Nitrate.

## 1.1 Methods

### Notes:

1. Some solids may not dissolve.
2. To optimise the readings an optional batch related calibration can be performed. Follow the procedure using 1 ml deionised water in place of the sample and subtract the reagent blank value from the final result.
3. Conversion:  
 $\text{mg/l NO}_3 = \text{mg/l N} \times 4.43$
4. ▲ N  
▼ NO<sub>3</sub>

Reagent / Accessories	Form of reagent/Quantity	Order-No.
<b>Set</b> VARIO Nitrate Chromotropic VARIO Nitra X Reagent tube VARIO deionised water	<b>Set</b> Powder Pack / 50 Reaction tube / 50 100 ml	535580

## 1.1 Methods

2 7 0

### Nitrite with Tablet

0.01 – 0.5 mg/l N



Ø 24 mm

prepare Zero  
press ZERO

1. Fill a clean vial (24 mm Ø) with **10 ml of the water sample**, close tightly with the cap.
2. Place the vial in the sample chamber making sure that the marks  $\times$  are aligned.
3. Press **ZERO** key.
4. Remove the vial from the sample chamber.
5. Add **one NITRITE LR tablet** straight from the foil to the water sample and crush the tablet using a clean stirring rod.
6. Close the vial tightly with the cap and swirl several times until the tablet is dissolved.
7. Place the vial in the sample chamber making sure that the marks  $\times$  are aligned.

Zero accepted  
prepare Test  
press TEST

Countdown  
10:00

8. Press **TEST** key.  
Wait for a **reaction period of 10 minutes**.

After the reaction period is finished the measurement starts automatically.

The result is shown in the display in mg/l Nitrite.

## 1.1 Methods

### Notes:

1. The following ions can produce interferences since under the reaction conditions they cause precipitation:  
Antimony (III), Iron (III), Lead, Mercury (I), Silver, Chloroplatinate, Metavanadate and Bismuth.  
Copper (II)-ions may cause lower test results as they accelerate the decomposition of the Diazonium salt.  
It is unlikely in practice that these interfering ions will occur in such high concentrations that they cause significant reading errors.
2. Conversion:  
 $\text{mg/l NO}_2 = \text{mg/l N} \times 3.29$
3. ▲ N  
▼ NO<sub>2</sub>

Reagent / Accessories	Form of reagent/Quantity	Order-No.
NITRITE LR	Tablet / 100	512310BT

## 1.1 Methods

2 7 2

### Nitrite LR with Vario Powder Pack

0.01 – 0.3 mg/l N



Ø 24 mm

prepare Zero  
press ZERO

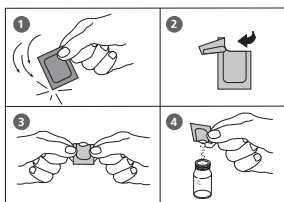

Zero accepted  
prepare Test  
press TEST

Countdown  
20:00

1. Fill a clean vial (24 mm Ø) with **10 ml of the water sample**, close tightly with the cap.
2. Place the vial in the sample chamber making sure that the **X** marks are aligned.
3. Press **ZERO** key.
4. Remove the vial from the sample chamber.
5. Add the contents of **one VARIO Nitri 3 Powder Pack** straight from the foil to the water sample.
6. Close the vial tightly with the cap and swirl several times to mix the contents.
7. Place the vial in the sample chamber making sure that the **X** marks are aligned.

8. Press **TEST** key.

Wait for a **reaction period of 20 minutes**.

After the reaction period is finished the measurement starts automatically.

The result is shown in the display in mg/l Nitrite.

## 1.1 Methods

### Notes:

#### 1. Interferences:

- Strong oxidizing and reducing substances interfere.
- Cupric and ferrous ions cause low results.
- Antimonous, Auric, Bismuth, Chloroplatinate, Ferric, Lead, Mercurous, Metavanadate, Silver ions interfere by causing precipitation.
- In samples with very high concentrations of Nitrate (> 100 mg/L N) a small amount of Nitrite will be found. Such high levels of Nitrate appear to undergo a slight amount of reduction to Nitrite, either spontaneously or during the reaction time of the test.

2. ▲ N  
▼ NO<sub>2</sub>

Reagent / Accessories	Form of reagent/Quantity	Order-No.
Vario Nitri 3 F10	Powder Pack / 100	530980

## 1.1 Methods

2 8 0

### Nitrogen, total LR with Vario Tube Test

0.5 – 25 mg/l N



Insert the adapter for 16 mm Ø vials.

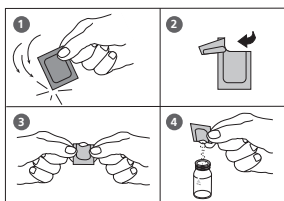

1. **Open two TN Hydroxide LR digestion vials** and add the contents of **one Vario TN Persulfate Rgt. Powder Pack** (Note 2, 3).
2. Add **2 ml deionised water** to the prepared vial (this is the blank, Note 4, 5).
3. Add **2 ml of the water sample** to the other prepared vial (this is the sample).
4. Close the vials with the caps and shake to mix the contents (at least 30 seconds, Note 6).
5. Heat the vials for **30 minutes** in the preheated reactor at a temperature of **100°C** (Note 7).
6. After 30 minutes remove the vials from the reactor. **(CAUTION: The vials are hot!)**  
Allow the vials to cool to room temperature.
7. Open the cooled digestion vials and add the contents of **one Vario TN Reagent A Powder Pack** to each vial (Note 2).
8. Close the vials with the caps and shake to mix the contents (at least 15 seconds).
9. Press **[↓]** key.  
Wait for a **reaction period of 3 minutes**.  
After the reaction period is finished proceed as follows:
10. Open the digestion vials and add the contents of **one Vario TN Reagent B Powder Pack** to each vial (Note 2).

Countdown  
3:00  
start: ↵



## 1.1 Methods

11. Close the vials with the caps and shake to mix the contents (at least 15 seconds, Note 8).

Countdown  
2:00  
start: ↓

12. Press **[↵]** key.  
Wait for a **reaction period of 2 minutes**.  
After the reaction period is finished proceed as follows:
13. Open **two TN Acid LR/HR (Reagent C) vials** and add **2 ml of the digested, treated blank** to one vial (this is the blank).
14. Add **2 ml of the digested, treated water sample** to the other TN Acid LR/HR vial (this is the sample).
15. Close the vials with the caps and swirl the vials gently several times to mix the contents (10 x, Note 9).  
**(CAUTION: Vials warm up).**
16. Place the vial (the blank) in the sample chamber making sure that the marks **Δ** are aligned.

prepare Zero  
press ZERO

Countdown  
5:00

17. Press **ZERO** key.  
Wait for a **reaction period of 5 minutes**.  
After the reaction period is finished the measurement starts automatically.
18. Remove the vial from the sample chamber.
19. Place the vial (the sample, Note 10) in the sample chamber making sure that the marks **Δ** are aligned.

Zero accepted  
prepare Test  
press TEST

20. Press **TEST** key.  
The result is shown in the display in mg/l Nitrogen.

**Notes and Reagent:** see page 196

## 1.1 Methods

2

8

1

### Nitrogen, total HR with Vario Tube Test

5 – 150 mg/l N



Insert the adapter for 16 mm Ø vials.

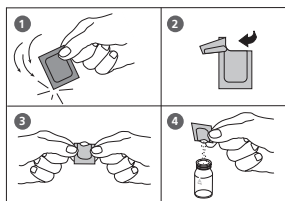

1. **Open two TN Hydroxide HR digestion vials** and add the contents of **one Vario TN Persulfate Rgt. Powder Pack** (Note 2, 3).
2. Add **0.5 ml deionised water** to the prepared vial (this is the blank, Note 4, 5).
3. Add **0.5 ml of the water sample** to the other prepared vial (this is the sample).
4. Close the vials with the caps and shake to mix the contents (at least 30 seconds, Note 6).
5. Heat the vials for **30 minutes** in the preheated reactor at a temperature of **100°C** (Note 7).
6. After 30 Minutes remove the vials from the reactor. **(CAUTION: The vials are hot!)** Allow the vials to cool to room temperature.
7. Open the cooled digestion vials and add the contents of **one Vario TN Reagent A Powder Pack** to each vial (Note 2).
8. Close the vials with the caps and shake to mix the contents (at least 15 seconds).
9. Press **[↵]** key.  
Wait for a **reaction period of 3 minutes**.  
After the reaction period is finished proceed as follows:
10. Open the digestion vials and add the contents of **one Vario TN Reagent B Powder Pack** to each vial (Note 2).

Countdown  
3:00  
start: ↵

## 1.1 Methods

11. Close the vials with the caps and shake to mix the contents (at least 15 seconds, Note 8).

Countdown

2:00

start: ↵

12. Press **[↵]** key.  
Wait for a **reaction period of 2 minutes**.  
After the reaction period is finished proceed as follows:
13. Open **two TN Acid LR/HR (Reagent C) vials** and add **2 ml of the digested, treated blank** to one vial (this is the blank).
14. Add **2 ml of the digested, treated water sample** to the other TN Acid LR/HR vial (this is the sample).
15. Close the vials with the caps and swirl the vials gently several times to mix the contents (10 x, Note 9).  
**(CAUTION: Vials warm up)**.
16. Place the vial (the blank) in the sample chamber making sure that the **Δ** marks are aligned.

prepare Zero

press ZERO

Countdown

5:00

17. Press **ZERO** key.  
Wait for a **reaction period of 5 minutes**.  
After the reaction period is finished the measurement starts automatically.
18. Remove the vial from the sample chamber.
19. Place the vial (the sample, Note 10) in the sample chamber making sure that the **Δ** marks are aligned.

Zero accepted

prepare Test

press TEST

20. Press **TEST** key.  
The result is shown in the display in mg/l Nitrogen.

**Notes and Reagent:** see page 196

# 1.1 Methods

## Notes:

1. Appropriate safety precautions and a good lab technique should be used during the whole procedure.
2. Use a funnel to add the reagent.
3. Wipe off any Persulfate reagent that may get on the lid or the tube threads.
4. Nitrogen, total LR:  
Volumes for samples and blank should always be metered by using 2 ml volumetric pipettes (class A).  
Nitrogen, total HR:  
Volumes for samples and blank should always be metered by using suitable pipettes (class A).
5. One blank is sufficient for each set of samples.
6. The reagent may not dissolve completely.
7. It is very important to remove the vials from the reactor after exactly 30 minutes.
8. The reagent will not completely dissolve.
9. Hold the vial in a vertical position with the cap pointing up. Turn the vial upside-down. Wait for all of the solution to flow down to the cap. Return the vial to the upright position. Wait for all the solution to flow to the bottom of the vial. This process is one inversion; 10 inversions = approx. 30 seconds.
10. The zero (stored in the dark) can be used for 7 days, if the measured samples were prepared with the same batch of reagent.
11. Large quantities of nitrogen free, organic compounds which are included in some water samples may reduce the effectiveness of the digestion by reacting with the Persulfate reagent. Samples which are well known to contain large quantities of organic compounds must be diluted and digestion and measurement must be repeated for checking the effectiveness of the digestion.
12. Application: for water, wastewater and seawater
13. Interferences:  
Interfering substances that resulted in a concentration change of 10%:  
Bromide more than 60 mg/l and Chloride more than 1000 mg/l produce positive interferences.  
TN = Total Nitrogen
14. ▲ N  
    NH<sub>4</sub>  
    ▼ NH<sub>3</sub>

## 1.1 Methods

### Nitrogen, total LR with Vario Tube Test

Reagent / Accessories	Form of reagent/Quantity	Order-No.
<b>Tube test contains:</b> VARIO TN HYDROX LR Tube VARIO PERSULFATE Reagent VARIO TN Reagent A VARIO TN Reagent B VARIO TN ACID LR/HR Tube VARIO deionised water	<b>Set</b> Digestion tube / 50 Powder Pack / 50 Powder Pack / 50 Powder Pack / 50 Reaction tube / 50 100 ml	535550

### Nitrogen, total HR with Vario Tube Test

Reagent / Accessories	Form of reagent/Quantity	Order-No.
<b>Tube test contains:</b> VARIO TN HYDROX HR Tube VARIO PERSULFATE Reagent VARIO TN Reagent A VARIO TN Reagent B VARIO TN ACID LR/HR Tube VARIO deionised water	<b>Set</b> Digestion tube / 50 Powder Pack / 50 Powder Pack / 50 Powder Pack / 50 Reaction tube / 50 100 ml	535560

## 1.1 Methods

2 9 0

### Oxygen, active\* with Tablet

0.1 – 10 mg/l O<sub>2</sub>



prepare Zero  
press ZERO

1. Fill a clean vial (24 mm Ø) with **10 ml of the water sample**, close tightly with the cap.
2. Place the vial in the sample chamber making sure that the X marks are aligned.
3. Press **ZERO** key.
4. Remove the vial from the sample chamber.
5. Add **one DPD No. 4 tablet** straight from the foil to the water sample and crush the tablet using a clean stirring rod.
6. Close the vial tightly with the cap and swirl several times until the tablet is dissolved.
7. Place the vial in the sample chamber making sure that the X marks are aligned.

Zero accepted  
prepare Test  
press TEST

Countdown  
2:00

8. Press **TEST** key.

Wait for a **reaction period of 2 minutes**.

After the reaction period is finished the measurement starts automatically.

The result is shown in the display in mg/l active Oxygen.

## 1.1 Methods

**Notes:**

\* **Active Oxygen is a synonym for a common disinfectant (based on "Oxygen") in Swimming Pool Treatment.**

1. When preparing the sample, the loss of Oxygen, e.g. by pipetting or shaking, must be avoided.
2. The analysis must take place immediately after taking the sample.

<b>Reagent / Accessories</b>	<b>Form of reagent/Quantity</b>	<b>Order-No.</b>
DPD No. 4	Tablet / 100	511220BT

## 1.1 Methods

2 9 2

### Oxygen, dissolved with Vacu-vials® K-7553 (see Notes)

10 – 800 µg/l O<sub>2</sub>

Insert the adapter for 13 mm Ø round vials.

prepare Zero  
press ZERO

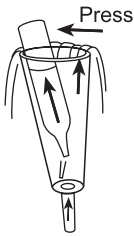

1. Place the blank in the sample chamber. The blank is part of the test kit.

2. Press **ZERO** key.

3. Remove the blank from the sample chamber.

4. Water should flow through the special sample container for several minutes to remove any air bubbles sticking at the surface.

The water must flow from the bottom to the top.

5. When the sample container is bubble-free press one Vacu-vial® into the lower edge of the sample container. The Vacu-vial® breaks at the neck and the vial fills automatically.

A small volume of inert gas remains in the Vacu-vial®.

6. Remove the Vacu-vial® point downwards from the sample container immediately.

As the contents of the vial has a higher density than water, it is important to remove the vial from the sample container within 5 seconds to prevent any loss of reagent.

7. The Vacu-vial® is closed with one finger (covered with a glove) to prevent entry of air. Invert the vial several times. Dry the outside of the vial.

8. Place the Vacu-vial® in the sample chamber.

9. Press **TEST** key.

The result is shown in the display in µg/l Oxygen.

Zero accepted  
prepare Test  
press TEST



## 1.1 Methods

### Notes:

1. This method is adapted from CHEMetrics. The measuring range and wavelength used for this photometer may differ from the data specified by CHEMetrics.
2. Read the original test instruction and the MSDS (delivered with the test) before performing the test. MSDS also available at [www.chemetrics.com](http://www.chemetrics.com).
3. Vacu-vials® should be stored in the dark and at room temperature.
4. Vacu-vials® is a registered trade mark of the company CHEMetrics, Inc. / Calverton, U.S.A.

Reagent / Accessories	Form of reagent/Quantity	Order-No.
Vacu-vials® / CHEMetrics K-7553	Test-Kit / 30	380450

## 1.1 Methods

3 0 0

### Ozone with Tablet

0.02 – 2 mg/l O<sub>3</sub>

Ozon

>> with Cl  
without Cl

The following selection is shown in the display:

>> with Cl

for the determination of Ozone in the presence of Chlorine.

>> without Cl

for the determination of Ozone in the absence of Chlorine.

Select the desired method with the arrow keys  
[▲] and [▼]. Confirm with [↵] key.

## 1.1 Methods

### Notes:

1. Vial cleaning:  
As many household cleaners (e.g. dishwasher detergent) contain reducing substances, the subsequent determination of Ozone may show lower results. To avoid any measurement errors, only use glassware free of Chlorine demand.  
Preparation: Put all applicable glassware into Sodium hypochlorite solution (0.1 g/l) for one hour, then rinse all glassware thoroughly with deionised water.
2. Preparing the sample:  
When preparing the sample, the loss of Ozone, e.g. by pipetting or shaking, must be avoided. The analysis must take place immediately after taking the sample.
3. The DPD colour development is carried out at a pH value of 6.2 to 6.5. The reagent tablet therefore contains a buffer for the pH adjustment.  
Strong alkaline or acidic water samples must be adjusted between pH 6 and pH 7 before the tablet is added (use 0.5 mol/l Sulfuric acid resp. 1 mol/l Sodium hydroxide).
4. Exceeding the measuring range:  
Concentrations above 6 mg/l Ozone can lead to results showing 0 mg/l. In this case, the water sample must be diluted with water free of Ozone. 10 ml of the diluted sample should be mixed with the reagent and the measurement repeated.
5. If ??? is displayed at the differentiated test result see page 356.
6. Oxidising agents such as Bromine, Chlorine etc. interfere as they react in the same way as Ozone.

## 1.1 Methods

3 0 0

### Ozone, in the presence of Chlorine with Tablet

0.02 – 2 mg/l O<sub>3</sub>



prepare Zero  
press ZERO

1. Fill a clean vial (24 mm Ø) with **10 ml of the water sample**, close tightly with the cap.
2. Place the vial in the sample chamber making sure that the  $\Sigma$  marks are aligned.
3. Press **ZERO** key.
4. Remove the vial from the sample chamber and **empty it, leaving a few drops remaining in the vial.**
5. Add **one DPD No. 1 tablet** and **one DPD No. 3 tablet** straight from the foil and crush the tablets using a clean stirring rod.
6. Add water sample to the 10 ml mark.
7. Close the vial tightly with the cap and swirl several times until the tablets are dissolved.
8. Place the vial in the sample chamber making sure that the  $\Sigma$  marks are aligned.

Zero accepted  
prepare T1  
press TEST

Countdown  
2:00

9. Press **TEST** key.

Wait for a **reaction period of 2 minutes.**

After the reaction period is finished the measurement starts automatically.

10. Remove the vial from the sample chamber, empty the vial, rinse vial and cap several times.
11. **Fill a second clean vial with 10 ml of water sample.**
12. Add **one GLYCINE tablet** straight from the foil and crush the tablet using a clean stirring rod.

## 1.1 Methods

13. Close the vial tightly with the cap and swirl several times until the tablet is dissolved.
14. Add **one DPD No. 1 tablet** and **one DPD No. 3 tablet** straight from the foil into the first cleaned vial and crush the tablets using a clean stirring rod.
15. **Transfer the contents of the second vial (Glycine solution) into the prepared vial (point 14).**
16. Close the vial tightly with the cap and swirl several times until the tablets are dissolved.
17. Place the vial in the sample chamber making sure that the  $\Sigma$  marks are aligned.
18. Press **TEST** key.

T1 accepted  
prepare T2  
press TEST

Countdown  
2:00

Wait for a **reaction period of 2 minutes**.

After the reaction period is finished the measurement starts automatically.

The result is shown in the display in:

\*,\*\* mg/l O<sub>3</sub>  
\*,\*\* mg/l total Cl

mg/l Ozone  
mg/l total Chlorine

### Notes:

See page 203

Reagent / Accessories	Form of reagent/Quantity	Order-No.
<b>Set</b> DPD No. 1 / No. 3	Tablet / per 100 inclusive stirring rod	517711BT
DPD No. 1	Tablet / 100	511050BT
DPD No. 3	Tablet / 100	511080BT
GLYCINE	Tablet / 100	512170BT

## 1.1 Methods



### Ozone, in absence of Chlorine with Tablet

0.02 – 2 mg/l O<sub>3</sub>



Ø 24 mm

prepare Zero  
press ZERO

1. Fill a clean vial (24 mm Ø) **with 10 ml of the water sample**, close tightly with the cap.
2. Place the vial in the sample chamber making sure that the  $\Sigma$  marks are aligned.
3. Press **ZERO** key.
4. Remove the vial from the sample chamber and **empty it, leaving a few drops remaining in the vial.**
5. Add **one DPD No. 1 tablet** and **one DPD No. 3 tablet** straight from the foil and crush the tablets using a clean stirring rod.
6. Add water sample to the 10 ml mark.
7. Close the vial tightly with the cap and swirl several times until the tablets are dissolved.
8. Place the vial in the sample chamber making sure that the  $\Sigma$  marks are aligned.
9. Press **TEST** key.  
Wait for a **reaction period of 2 minutes.**

Zero accepted  
prepare Test  
press TEST

Countdown  
2:00

After the reaction period is finished the measurement starts automatically.

The result is shown in the display in  
mg/l Ozone.

## 1.1 Methods

**Notes:** See page 203

<b>Reagent / Accessories</b>	<b>Form of reagent/Quantity</b>	<b>Order-No.</b>
<b>Set</b> DPD No. 1 / No. 3	Tablet / per 100 inclusive stirring rod	517711BT
DPD No. 1	Tablet / 100	511050BT
DPD No. 3	Tablet / 100	511080BT

## 1.1 Methods

7

0

### PHMB (Biguanide) with Tablet

2 – 60 mg/l PHMB



Ø 24 mm

prepare Zero  
press ZERO

1. Fill a clean vial (24 mm Ø) with **10 ml of the water sample**, close tightly with the cap.
2. Place the vial in the sample chamber making sure that the  $\Sigma$  marks are aligned.
3. Press **ZERO** key.
4. Remove the vial from the sample chamber.
5. Add **one PHMB PHOTOMETER tablet** straight from the foil to the water sample and crush the tablet using a clean stirring rod.
6. Close the vial tightly with the cap and swirl several times until the tablet is dissolved.
7. Place the vial in the sample chamber making sure that the  $\Sigma$  marks are aligned.
8. Press **TEST** key.

Zero accepted  
prepare Test  
press TEST

The result is shown in the display in mg/l PHMB.



## 1.1 Methods

### Notes:

1. Clean vials with the brush immediately after analysis.
2. Vials and stirring rods may turn blue after prolonged use. In this case clean vials and stirring rods with a laboratory detergent (see chapter 1.2.2 Cleaning of vials and accessories for analysis). Rinse vials and caps thoroughly with tap water and then with deionised water.
3. The test result is influenced by Hardness and Total Alkalinity.  
The calibration of this method was done using water with the following concentration:  
Ca-Hardness: 200 mg/l  $\text{CaCO}_3$   
Total Alkalinity: 120 mg/l  $\text{CaCO}_3$

Reagent / Accessories	Form of reagent/Quantity	Order-No.
PHMB PHOTOMETER	Tablet / 100	516100BT

## 1.1 Methods

3 2 0

### Phosphate, ortho LR with Tablet

0.05 – 4 mg/l PO<sub>4</sub>  
Determination of ortho-Phosphate ions

3 2 1

### Phosphate, ortho HR with Tablet

1 – 80 mg/l PO<sub>4</sub>  
Determination of ortho-Phosphate ions

3 2 3

### Phosphate, ortho with Vario Powder Pack

0.06 – 2.5 mg/l PO<sub>4</sub>  
Determination of ortho-Phosphate ions

3 2 4

### Phosphate, ortho with Vario Tube Test

0.06 – 5 mg/l PO<sub>4</sub>  
Determination of ortho-Phosphate ions

3 2 7

### Phosphat 1, ortho with Vacu-vials®

5 – 40 mg/l PO<sub>4</sub>  
Determination of ortho-Phosphate ions

3 2 8

### Phosphat 2, ortho with Vacu-vials®

0.05 – 5 mg/l PO<sub>4</sub>  
Determination of ortho-Phosphate ions

3 2 5

### Phosphate, acid hydrolyzable with Vario Tube Test

0.02 – 1.6 mg/l P  
Determination of ortho-Phosphate ions + condensed,  
inorganic Phosphates

3 2 6

### Phosphate, total with Vario Tube Test

0.02 – 1.1 mg/l P  
Determination of ortho-Phosphate ions + condensed,  
inorganic Phosphates + organically combined Phosphates

3 3 4

### Phosphate, LR with Liquid reagent

0.1 – 10 mg/l PO<sub>4</sub>  
Determination of ortho-Phosphate-Ions + condensed,  
inorganic Phosphate + organic combined Phosphates

## 1.1 Methods



### Phosphate, HR with Liquid reagent

5 – 80 mg/l PO<sub>4</sub>

Determination of ortho-Phosphate-Ions + condensed, inorganic Phosphate + organic combined Phosphates

Additional information can be found in the notes for each method.

#### General:

Ortho-Phosphate ions react with the reagent to form an intense blue colour (methods **320**, **323**, **324**, **325** and **326**).

Phosphate in organic and condensed inorganic forms (meta-, pyro- and polyphosphates) must be converted to ortho-Phosphate ions before analysis.

Pretreatment of the sample with acid and heat provides the conditions for hydrolysis of the condensed inorganic forms. Organically combined phosphates are converted to ortho-Phosphate ions by heating with acid and persulfate.

The amount of organically combined phosphates can be calculated:

mg/l Phosphate, organic = mg/l Phosphate, total – mg/l Phosphate, acid hydrolysable

In methods **321** and **327** the ortho-Phosphate ions react with the Vanadate-molybdate-reagent under acid conditions to form a yellow coloured product.

#### Notes – only for tube tests and tests with powder packs:

**323, 324, 325, 326**

1. Application: for water, wastewater and seawater.
2. Highly buffered samples or samples with extreme pH values should be adjusted between pH 6 and pH 7 before analysis (with 1 mol/l Hydrochloric acid or 1 mol/l Sodium hydroxide).
3. Interferences:  
Large amounts of turbidity may cause inconsistent results.

#### Interfering substance

Aluminium

Arsenate

Chromium

Copper

Iron

Nickel

Silica (Silicium dioxide)

Silicate

Sulfide

Zinc

#### Interference level:

greater than 200 mg/l

at any level

greater than 100 mg/l

greater than 10 mg/l

greater than 100 mg/l

greater than 300 mg/l

greater than 50 mg/l

greater than 10 mg/l

at any level

greater than 80 mg/l

### Phosphate, ortho ≙ Phosphorus, reactive

## 1.1 Methods

3

2

0

### Phosphate, ortho LR with Tablet

0.05 – 4 mg/l PO<sub>4</sub>



Ø 24 mm

prepare Zero  
press ZERO

1. Fill a clean vial (24 mm Ø) with **10 ml of the water sample**, close the cap tightly.
2. Place the vial in the sample chamber making sure that the marks  $\times$  are aligned.
3. Press **ZERO** key.

4. Remove the vial from the sample chamber.
5. Add **one PHOSPHATE No. 1 LR tablet** straight from the foil to the water sample and crush the tablet using a clean stirring rod.
6. Add **one PHOSPHATE No. 2 LR tablet** straight from the foil to the same water sample and crush the tablet using a clean stirring rod.
7. Close the vial tightly with the cap and swirl several times until the tablet is dissolved.
8. Place the vial in the sample chamber making sure that the marks  $\times$  are aligned.
9. Press **TEST** key.  
Wait for a **reaction period of 10 minutes**.

Zero accepted  
prepare Test  
press TEST

Countdown  
10:00

After the reaction period is finished the measurement starts automatically.

The result is shown in the display in mg/l ortho-Phosphate.

## 1.1 Methods

### Notes:

1. Only ortho-Phosphate ions react.
2. The tablets must be added in the correct sequence.
3. The test sample should have a pH-Value between 6 and 7.
4. Interferences:  
Higher concentrations of Cu, Ni, Cr (III), V (V) and W (VI) interfere due to their colour.  
Silicates do not interfere (masked by Citric acid in the tablets).
5. see also page 211
6. Conversion:  
 $\text{mg/l P} = \text{mg/l PO}_4 \times 0.33$   
 $\text{mg/l P}_2\text{O}_5 = \text{mg/l PO}_4 \times 0.75$
7. ▲  $\text{PO}_4$   
P  
▼  $\text{P}_2\text{O}_5$

Reagent / Accessories	Form of reagent/Quantity	Order-No.
<b>Set</b> PHOSPHATE LR No. 1 / No. 2	Tablet / per 100 inclusive stirring rod	517651BT
PHOSPHATE LR No. 1	Tablet / 100	513040BT
PHOSPHATE LR No. 2	Tablet / 100	513050BT

## 1.1 Methods

3

2

1

### Phosphate HR, ortho with Tablet

1 – 80 mg/l PO<sub>4</sub>



Ø 24 mm

prepare Zero  
press ZERO

1. Fill a clean vial (24 mm Ø) with **10 ml of the water sample**, close tightly with the cap.
2. Place the vial in the sample chamber making sure that the X marks are aligned.
3. Press **ZERO** key.

4. Remove the vial from the sample chamber.

5. Add **one PHOSPHATE HR P1 tablet** straight from the foil to the water sample and crush the tablet using a clean stirring rod.

6. Add **one PHOSPHATE HR P2 tablet** straight from the foil to the same water sample and crush the tablet using a clean stirring rod.

7. Close the vial tightly with the cap and swirl several times until the tablets are dissolved.

8. Place the vial in the sample chamber making sure that the X marks are aligned.

9. Press **TEST** key.

Wait for a **reaction period of 10 minutes**.

After the reaction period is finished the measurement starts automatically.

The result is shown in the display in mg/l ortho-Phosphate.

Zero accepted  
prepare Test  
press TEST

Countdown  
10:00

## 1.1 Methods

### Notes:

1. For samples under 5 mg/l  $\text{PO}_4$  it is recommended to analyse the water sample with method 320 "Posphate LR, ortho with Tablet".
2. Only ortho-Phosphate ions react.
3. see also page 211
4. Conversions:  
 $\text{mg/l P} = \text{mg/l PO}_4 \times 0.33$   
 $\text{mg/l P}_2\text{O}_5 = \text{mg/l PO}_4 \times 0.75$
5. ▲  $\text{PO}_4$   
P  
▼  $\text{P}_2\text{O}_5$

Reagent / Accessories	Form of reagent/Quantity	Order-No.
<b>Set</b> PHOSPHATE HR P 1 / P 2	Tablet / per 100 inclusive stirring rod	517661BT
PHOSPHATE HR P1	Tablet / 100	515810BT
PHOSPHATE HR P2	Tablet / 100	515820BT

## 1.1 Methods

3

2

3

### Phosphate, ortho with Vario Powder Pack

0.06 – 2.5 mg/l PO<sub>4</sub>



Ø 24 mm

prepare Zero  
press ZERO

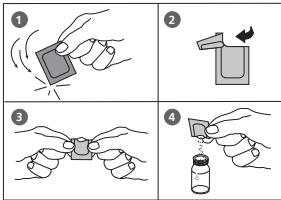

1. Fill a clean vial (24 mm Ø) with **10 ml of the water sample**, close tightly with the cap.
2. Place the vial in the sample chamber making sure that the X marks are aligned.
3. Press **ZERO** key.
4. Remove the vial from the sample chamber.
5. Add the contents of **one VARIO Phosphate Rgt. F10 Powder Pack** straight from the foil to the water sample.
6. Close the vial tightly with the cap and swirl several times to mix the contents (approx. 10-15 sec., Note 1).
7. Place the vial in the sample chamber making sure that the X marks are aligned.

Zero accepted  
prepare Test  
press TEST

Countdown  
2:00

8. Press **TEST** key.  
Wait for a **reaction period of 2 minutes**.

After the reaction period is finished the measurement starts automatically.

The result is shown in the display in mg/l ortho-Phosphate.



## 1.1 Methods

### Notes:

1. The reagent does not dissolve completely.
2. see also page 211
3. Conversions:  
 $\text{mg/l P} = \text{mg/l PO}_4 \times 0.33$   
 $\text{mg/l P}_2\text{O}_5 = \text{mg/l PO}_4 \times 0.75$
4. ▲  $\text{PO}_4$   
P  
▼  $\text{P}_2\text{O}_5$

Reagent / Accessories	Form of reagent/Quantity	Order-No.
<b>Set</b> VARIO PHOS3 F10	Powder Pack / 2 x 50 VARIO PHOSPHATE RGT. F10	531550

## 1.1 Methods

3

2

4

### Phosphate, ortho with Vario Tube Test

0.06 – 5 mg/l PO<sub>4</sub>



Insert the adapter for 16 mm Ø vials.

1. Open the white cap of one **tube PO<sub>4</sub>-P Dilution** and add **5 ml of the water sample**.
2. Close the vial tightly with the cap and swirl several times to dissolve.
3. Place the vial in the sample chamber making sure that the  $\Delta$  marks are aligned.

prepare Zero  
press ZERO

4. Press **ZERO** key.

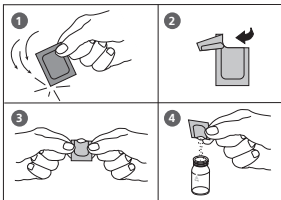

5. Remove the vial from the sample chamber.
6. Add the contents of **one VARIO Phosphate Rgt. F10 Powder Pack** straight from the foil to the water sample (Note 1).
7. Close the vial tightly with the cap and swirl several times to mix the contents (approx. 10-15 sec., Note 2).
8. Place the vial in the sample chamber making sure that the  $\Delta$  marks are aligned.

Zero accepted  
prepare Test  
press TEST

9. Press **TEST** key.

Wait for a **reaction period of 2 minutes**.

After the reaction period is finished the measurement starts automatically.

The result is shown in the display in mg/l ortho-Phosphate.

Countdown  
2:00

## 1.1 Methods

### Notes:

1. Use a funnel to add the reagent.
2. The reagent does not dissolve completely.
3. see also page 211
4. Conversions:  
 $\text{mg/l P} = \text{mg/l PO}_4 \times 0.33$   
 $\text{mg/l P}_2\text{O}_5 = \text{mg/l PO}_4 \times 0.75$
5. ▲  $\text{PO}_4$   
P  
▼  $\text{P}_2\text{O}_5$

Reagent / Accessories	Form of reagent/Quantity	Order-No.
<b>Tube test contains:</b> VARIO Dilution Vial VARIO PHOSPHATE RGT F10 PP VARIO deionised water	<b>Set</b> Reaction tube / 50 Powder Pack / 50 100 ml	535200

## 1.1 Methods

3 2 7

### Phosphate 1, ortho with Vacu-vials® K-8503 (see Notes)

5 – 40 mg/l PO<sub>4</sub>

Insert the adapter for 13 mm Ø vials.

1. Place the blank in the sample chamber. The blank is part of the test kit.

prepare Zero  
press ZERO

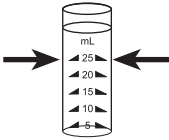

2. Press **ZERO** key.
3. Remove the blank from the sample chamber.
4. Fill the sample container to the 25 ml mark with the water sample.
5. Place one Vacu-vial® in the sample container. Snap the tip by pressing the vial against the side of the sample container.

The Vacu-vial® breaks at the neck and the vial fills automatically.

A small volume of inert gas remains in the Vacu-vial®.

6. Mix the contents of the Vacu-vial® by inverting it several times, allowing the bubble to move from one end to the other. Dry the outside of the vial.
7. Place the Vacu-vial® in the sample chamber.

Zero accepted  
prepare Test  
press TEST

Countdown  
5:00

8. Press **TEST** key.

Wait for a **reaction period of 5 minutes**.

After the reaction period is finished the measurement starts automatically.

The result is shown in the display in mg/l ortho-Phosphate.

## 1.1 Methods

### Notes:

1. This method is adapted from CHEMetrics. The measuring range and wavelength used for this photometer may differ from the data specified by CHEMetrics.
2. Read the original test instruction and the MSDS (delivered with the test) before performing the test. MSDS also available at [www.chemetrics.com](http://www.chemetrics.com).
3. Vacu-vials® is a registered trade mark of the company CHEMetrics, Inc. / Calverton, U.S.A.
4. Only ortho-Phosphate ions react.
5. Sulfide, Thiosulfate and Thiocyanate cause low test results.
6. ▲ PO<sub>4</sub>  
P  
▼ P<sub>2</sub>O<sub>5</sub>

Reagent / Accessories	Form of reagent/Quantity	Order-No.
Vacu-vials® / CHEMetrics K-8503	Test-Kit / 30	380460

## 1.1 Methods

3

2

8

### Phosphate 2, ortho with Vacu-vials® K-8513 (see Notes)

0.05 – 5 mg/l PO<sub>4</sub>

Insert the adapter for 13 mm Ø vials.

prepare Zero  
press ZERO

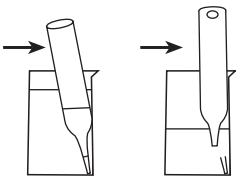
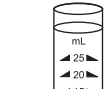
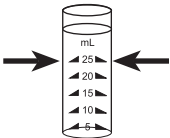

Zero accepted  
prepare Test  
press TEST

Countdown  
3:00

1. Place the blank in the sample chamber. The blank is part of the test kit.

2. Press **ZERO** key.

3. Remove the blank from the sample chamber.

4. Fill the sample container to the 25 ml mark with the water sample.

5. Fill the sample container with drops of the same size by holding the bottle vertically and squeeze slowly:

#### 2 drops A-8500 Activator Solution

6. Close the sample container with the cap tightly and swirl several times to mix the contents.

7. Place one Vacu-vial® in the sample container. Snap the tip by pressing the vial against the side of the sample container. The Vacu-vial® breaks at the neck and the vial fills automatically. A small volume of inert gas remains in the Vacu-vial®.

8. Mix the contents of the Vacu-vial® by inverting it several times, allowing the bubble to move from one end to the other. Dry the outside of the vial.

9. Place the Vacu-vial® in the sample chamber.

10. Press **TEST** key.

Wait for a **reaction period of 3 minutes**.

After the reaction period is finished the measurement starts automatically.

The result is shown in the display in mg/l ortho-Phosphate.

## 1.1 Methods

### Notes:

1. This method is adapted from CHEMetrics. The measuring range and wavelength used for this photometer may differ from the data specified by CHEMetrics.
2. Read the original test instruction and the MSDS (delivered with the test) before performing the test. MSDS also available at [www.chemetrics.com](http://www.chemetrics.com).
3. Vacu-vials® is a registered trade mark of the company CHEMetrics, Inc. / Calverton, U.S.A.
4. Only ortho-Phosphate ions react.
5. Sulfide, Thiosulfate and Thiocyanate cause low test results.
6. ▲ PO<sub>4</sub>  
P  
▼ P<sub>2</sub>O<sub>5</sub>

Reagent / Accessories	Form of reagent/Quantity	Order-No.
Vacu-vials® / CHEMetrics K-8513	Test-Kit / 30	380480

## 1.1 Methods

3 2 5

### Phosphate, acid hydrolyzable with Vario Tube Test

0.02 – 1.6 mg/l P ( $\Delta$  0.06 – 5 mg/l  $\text{PO}_4$ )



Insert the adapter for 16 mm Ø vials.

1. Open the white cap of one **digestion tube PO4-P Acid reagent** and add **5 ml of the water sample**.
2. Close the vial tightly with the cap and invert gently several times to mix the contents.
3. Heat the vials for **30 minutes** in the preheated reactor at a temperature of **100°C**.
4. After 30 minutes remove the vial from the reactor. **(CAUTION: The vials are hot!)** Allow the vials to cool to room temperature.
5. Open the cooled digestion vial and add **2 ml 1.00 N Sodium Hydroxide solution** to the vial.
6. Close the vial with the cap and invert gently several times to mix the contents.
7. Place the vial in the sample chamber making sure that the  $\Delta$  marks are aligned.
8. Press **ZERO** key.
9. Remove the vial from the sample chamber.
10. Add the contents of **one VARIO Phosphate Rgt. F10 Powder Pack** straight from the foil to the vial (Note 2).
11. Close the vial tightly with the cap and swirl several times to mix the contents (approx. 10-15 sec., Note 3).
12. Place the vial in the sample chamber making sure that the  $\Delta$  marks are aligned.
13. Press **TEST** key.  
Wait for a **reaction period of 2 minutes**.

prepare Zero  
press ZERO

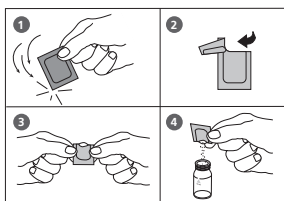

Zero accepted  
prepare Test  
press TEST

Countdown  
2:00

After the reaction period is finished the measurement starts automatically.

The result is shown in the display in mg/l acid hydrolyzable Phosphate.



## 1.1 Methods

### Notes:

1. Appropriate safety precautions and a good lab technique should be used during the whole procedure.
2. Use a funnel to add the reagent.
3. The reagent does not dissolve completely.
4. see also page 211
5. Conversions:  
 $\text{mg/l PO}_4 = \text{mg/l P} \times 3.07$   
 $\text{mg/l P}_2\text{O}_5 = \text{mg/l P} \times 2.29$
6. ▲  $\text{PO}_4$   
     P  
     ▼  $\text{P}_2\text{O}_5$

Reagent / Accessories	Form of reagent/Quantity	Order-No.
<b>Tube test contains:</b> VARIO Acid Reagent Vial VARIO PHOSPHATE RGT F10 PP VARIO Potassium F10 Persulfate VARIO Sodium Hydroxide 1,54 N VARIO deionised water VARIO Sodium Hydroxide 1,00 N	<b>Set</b> Reaction tube / 50 Powder Pack / 50 Powder Pack / 50 Solution / 100 ml 100 ml Solution / 100 ml	535250

## 1.1 Methods

3

2

6

### Phosphate, total with Vario Tube Test

0.02 – 1.1 mg/l P ( $\Delta$  0.06 – 3.5 mg/l PO<sub>4</sub>)

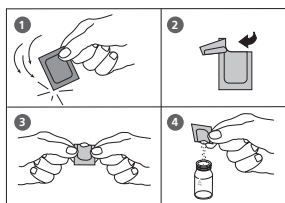

Insert the adapter for 16 mm Ø vials.

1. Open the white cap of one **digestion tube PO4-P Acid reagent** and add **5 ml of the water sample**.
2. Add the contents of **one Vario Potassium Persulfate F10 Powder Pack** straight from the foil to the vial (Note 2).
3. Close the vial tightly with the cap and invert several times to mix the contents.
4. Heat the vials for **30 minutes** in the preheated reactor at a temperature of **100°C**.
5. After 30 minutes remove the vial from the reactor. **(CAUTION: The vials are hot!)**  
Allow the vials to cool to room temperature.
6. Open the cooled digestion vial and add **2 ml 1.54 N Sodium Hydroxide Solution** to the vial.
7. Close the vial with the cap and invert gently several times to mix the contents.
8. Place the vial in the sample chamber making sure that the  $\Delta$  marks are aligned.
9. Press **ZERO** key.
10. Remove the vial from the sample chamber.
11. Add the contents of **one VARIO Phosphate Rgt. F10 Powder Pack** straight from the foil to the vial (Note 2).
12. Close the vial tightly with the cap and swirl several times to mix the contents (approx. 10-15 sec., Note 3).
13. Place the vial in the sample chamber making sure that the  $\Delta$  marks are aligned.
14. Press **TEST** key.  
Wait for a **reaction period of 2 minutes**.  
  
After the reaction period is finished the measurement starts automatically.  
  
The result is shown in the display in mg/l total Phosphate.

prepare Zero  
press ZERO

Zero accepted  
prepare Test  
press TEST

Countdown  
2:00

## 1.1 Methods

### Notes:

1. Appropriate safety precautions and a good lab technique should be used during the whole procedure.
2. Use a funnel to add the reagent.
3. The reagent does not dissolve completely.
4. see also page 211
5. Conversions:  
 $\text{mg/l PO}_4 = \text{mg/l P} \times 3.07$   
 $\text{mg/l P}_2\text{O}_5 = \text{mg/l P} \times 2.29$
6. ▲ P  
    PO<sub>4</sub>  
    ▼ P<sub>2</sub>O<sub>5</sub>

Reagent / Accessories	Form of reagent/Quantity	Order-No.
<b>Tube test contains:</b> VARIO Acid Reagent Vial VARIO PHOSPHATE RGT F10 PP VARIO Potassium F10 Persulfate VARIO Sodium Hydroxide 1,54 N VARIO deionised water	<b>Set</b> Reaction tube / 50 Powder Pack / 50 Powder Pack / 50 Solution / 100 ml 100 ml	535210

## 1.1 Methods

3

3

4

### Phosphate LR with Liquid reagent

0.1 – 10 mg/l PO<sub>4</sub>

This test is suitable for determining ortho-Phosphate in boiler waters and potable water supplies. Samples should be filtered prior to analysis to remove any suspended insoluble phosphate. A GF/C filter is suitable.

Unscrew the two halves of the filter holder and place one GF/C filter circle onto the base section. Screw the two parts together again, **ensuring the O ring is correctly located.**

1. Fill a clean 20 ml syringe with approx. 14 ml water sample.
2. Connect the syringe to the filtration assembly and discharge the syringe to waste, down to the 10 ml mark.
3. Fill a clean vial (24 mm Ø) with **10 ml of water sample from the prepared syringe**, close tightly with the cap.
4. Place the vial in the sample chamber making sure that the X marks are aligned.
5. Press **ZERO** key.

prepare Zero  
press ZERO

6. Remove the vial from the sample chamber.
7. Fill the vial with drops of the same size by holding the bottle vertically and squeeze slowly:  
**50 drops KS80 (CRP)**
8. Close the vial tightly with the cap and invert several times to mix the contents.

## 1.1 Methods

9. Add **one level spoon of reagent KP119 (Ascorbic Acid)** to the same water sample (note 1).
10. Close the vial tightly with the cap and swirl several times to dissolve the powder.
11. Place the vial in the sample chamber making sure that the  $\Sigma$  marks are aligned.
12. Press **TEST** key.

**Wait for a reaction period of 10 minutes.**

After the reaction period is finished the measurement starts automatically.

The result is shown in the display in mg/l Phosphate.

Zero accepted  
prepare Test  
press TEST

Countdown  
10:00

**Notes:**

1. For correct dosage the spoon supplied with the reagents must be used.
2. For the analysis of Polyphosphate and total Phosphate a prior digestion is required (see page 230).
3. Sample temperature should be between 15 and 30°C.
4. Conversions:  
 $\text{mg/l P} = \text{mg/l PO}_4 \times 0,33$   
 $\text{mg/l P}_2\text{O}_5 = \text{mg/l PO}_4 \times 0,75$
5. ▲ P  
     PO<sub>4</sub>  
     ▼ P<sub>2</sub>O<sub>5</sub>

Reagent / Accessories	Form of reagent/Quantity	Order-No.
KS80 – CRP Reagent KP119 – Ascorbic Acid	Liquid reagent / 2 x 65 ml Powder / 20 g	56L008065 56P011920
For digestion method: KS278 (50% Sulphuric Acid) KS135 (Phenolphthalein Substitute Indikator) KS144 (Calcium Hardness Buffer) KP962 (Ammonium Persulfate Powder)	Liquid reagent / 65 ml Liquid reagent / 65 ml Liquid reagent / 65 ml Powder / 20 g	56L027865 56L013565 56L014465 56P096240

## 1.1 Methods

3

3

4

### Polyphosphate LR with Liquid reagent

0.1 – 10 mg/l PO<sub>4</sub>

This test will give total inorganic phosphate.  
Polyphosphate being determined by the difference of total inorganic phosphate and ortho-Phosphate.

1. Fill a clean 100-ml-Erlenmeyer flask with **50 ml homogenized sample**.
2. Add **15 drops of KS278 (50% Sulphuric Acid)** to the same water sample.
3. Boil for **20 minutes**, maintaining the sample volume above 25 ml with deionised water.
4. Swirl gently several times to mix the contents and allow the Erlenmeyer flask to cool to room temperature.
5. Fill the Erlenmeyer flask with drops of the same size by holding the bottle vertically and squeeze slowly:  
**2 drops KS135 (Phenolphthalein Substitute Indicator)**
6. Add drops of **KS144 (Calcium Hardness Buffer)**, one drop at a time **with mixing**, until a pale pink colour just appears.
7. Fill the sample up to 50ml with deionised water.
8. Proceed as in **point 3** of the method before (page 228).

The result is shown in the display in mg/l inorganic total Phosphate (ortho-Phosphate or Polyphosphate).

## 1.1 Methods



### Total Phosphate LR with Liquid reagent

0.1 – 10 mg/l PO<sub>4</sub>

This test will measure all phosphorous containing compounds present in the sample, including ortho-Phosphate, Polyphosphate and organic phosphorous compounds.

1. Fill a clean 100-ml-Erlenmeyer flask with **50 ml homogenized sample**.
2. Add one spoon **KP962 (Ammonium Persulfate Powder)** to the prepared water sample
3. Add **15 drops of KS278 (50% Sulphuric Acid)** to the same water sample.
4. Boil for **20 minutes**, maintaining the sample volume above 25 ml with deionised water.
5. Swirl gently several times to mix the contents and allow the Erlenmeyer flask to cool to room temperature.
6. Fill the Erlenmeyer flask with drops of the same size by holding the bottle vertically and squeeze slowly:  
**2 drops KS135 (Phenolphthalein Substitute Indicator)**
7. Add drops of **KS144 (Calcium Hardness Buffer)**, one drop at a time **with mixing**, until a pale pink colour just appears.
8. Fill the sample up to 50ml with deionised water.
9. Proceed as in **point 3** of the method before (page 228).

The result is shown in the display in mg/l total-Phosphate.

## 1.1 Methods

3

3

5

### Phosphate HR with Liquid reagent

5 – 80 mg/l PO<sub>4</sub>

This test is suitable for determining ortho-Phosphate in boiler waters and potable water supplies. Samples should be filtered prior to analysis to remove any suspended insoluble phosphate. A GF/C filter is suitable.

Unscrew the two halves of the filter holder and place one GF/C filter circle onto the base section. Screw the two parts together again, **ensuring the O ring is correctly located.**

1. Fill a clean 20 ml syringe with approx. 14 ml water sample.
2. Connect the syringe to the filtration assembly and discharge the syringe to waste, down to the 10 ml mark.
3. Fill a clean vial (24 mm Ø) with **10 ml of water sample from the prepared syringe**, close tightly with the cap.
4. Place the vial in the sample chamber making sure that the X marks are aligned.
5. Press **ZERO** key.
6. Remove the vial from the sample chamber.
7. Fill the vial with drops of the same size by holding the bottle vertically and squeeze slowly:  
**25 drops KS228 (Ammonium Molybdate)**
8. Close the vial tightly with the cap and invert several times to mix the contents.

prepare Zero  
press ZERO



## 1.1 Methods

9. Add **25 drops of KS229 (Ammonium Metavanadate)** solution to the same water sample.
10. Close the vial tightly with the cap and invert several times to mix the contents.
11. Place the vial in the sample chamber making sure that the  $\times$  marks are aligned.
12. Press **TEST** key.  
**Wait for a reaction period of 10 minutes.**

**Zero accepted  
prepare Test  
press TEST**

**Countdown  
10:00**

After the reaction period is finished the measurement starts automatically.

The result is shown in the display in mg/l Phosphate.

### Notes:

1. For the analysis of Polyphosphate and total Phosphate a prior digestion is required (see page 234).
2. Reagents and accessories available on request.
3. Conversions:  
 $\text{mg/l P} = \text{mg/l PO}_4 \times 0,33$   
 $\text{mg/l P}_2\text{O}_5 = \text{mg/l PO}_4 \times 0,75$
4. ▲ P  
     PO<sub>4</sub>  
     ▼ P<sub>2</sub>O<sub>5</sub>

Reagent / Accessories	Form of reagent/Quantity	Order-No.
KS228 (Ammonium Molybdate)	Liquid reagent / 65 ml	56L022865
KS229 (Ammonium Metavanadate)	Liquid reagent / 65 ml	56L022965
For digestion method: KS278 (50% Sulphuric Acid)	Liquid reagent / 65 ml	56L027865
KS135 (Phenolphthalein Substitute Indicator)	Liquid reagent / 65 ml	56L013565
KS144 (Calcium Hardness Buffer)	Liquid reagent / 65 ml	56L014465
KP962 (Ammonium Persulfate Powder)	Powder	56P096240

## 1.1 Methods

3

3

5

### Polyphosphate HR with Liquid reagent

5 – 80 mg/l PO<sub>4</sub>

This test will give total inorganic phosphate.  
Polyphosphate being determined by the difference of total inorganic phosphate and ortho-Phosphate.

1. Fill a clean 100-ml-Erlenmeyer flask with **50 ml homogenized sample**.
2. Add **15 drops of KS278 (50% Sulphuric Acid)** to the same water sample.
3. Boil for **20 minutes**, maintaining the sample volume above 25 ml with deionised water.
4. Swirl gently several times to mix the contents and allow the Erlenmeyer flask to cool to room temperature.
5. Fill the Erlenmeyer flask with drops of the same size by holding the bottle vertically and squeeze slowly:  
**2 drops KS135 (Phenolphthalein Substitute Indicator)**
6. Add drops of **KS144 (Calcium Hardness Buffer)**, one drop at a time **with mixing**, until a pale pink colour just appears.
7. Fill the sample up to 50ml with deionised water.
8. Proceed as in **point 3** of the method before (page 232).

The result is shown in the display in mg/l inorganic total Phosphate (ortho-Phosphate or Polyphosphate).

## 1.1 Methods



### Total Phosphate HR with Liquid reagent

5 – 80 mg/l PO<sub>4</sub>

This test will measure all phosphorous containing compounds present in the sample, including ortho-Phosphate, Polyphosphate and organic phosphorous compounds.

1. Fill a clean 100-ml-Erlenmeyer flask with **50 ml homogenized sample**.
2. Add one spoon **KP962 (Ammonium Persulfate Powder)** to the prepared water sample
3. Add **15 drops of KS278 (50% Sulphuric Acid)** to the same water sample.
4. Boil for **20 minutes**, maintaining the sample volume above 25 ml with deionised water.
5. Swirl gently several times to mix the contents and allow the Erlenmeyer flask to cool to room temperature.
6. Fill the Erlenmeyer flask with drops of the same size by holding the bottle vertically and squeeze slowly:  
**2 drops KS135 (Phenolphthalein Substitute Indicator)**
7. Add drops of **KS144 (Calcium Hardness Buffer)**, one drop at a time **with mixing**, until a pale pink colour just appears.
8. Fill the sample up to 50ml with deionised water.
9. Proceed as in **point 3** of the method before (page 232).

The result is shown in the display in mg/l total-Phosphate.

## 1.1 Methods



### Phosphonates Persulfate UV oxidation method with Vario Powder Pack

0 – 125 mg/l (see Table 1)

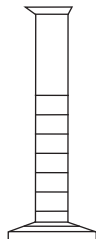

Ø 24 mm

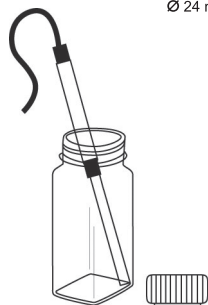

Countdown 1  
10:00  
start: ↵



Ø 24 mm

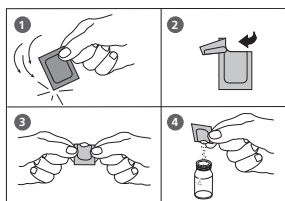

1. Choose the appropriate sample volume from table 1 (see following pages).
2. Pipette the chosen sample volume into a clean 50 ml graduated cylinder. If necessary fill up with deionised water to the 50 ml mark and mix well.
3. Fill a clean vial (24 mm Ø) with **10 ml of the prepared water sample** (this is the blank).
4. Transfer **25 ml of the prepared water sample** into the digestion vial.
5. Add the contents of **one Vario Potassium Persulfate F10 Powder Pack** straight from the foil to the digestion vial.
6. Close the digestion vial tightly with the cap and swirl until the reagent is dissolved completely.
7. Insert the UV lamp into the digestion vial (Note 3, 4, 5).  
**CAUTION: Wear UV safety goggles!**
8. Switch the UV lamp on and wait for a **reaction period of 10 minutes**.
9. After the reaction period is finished switch the UV lamp off and remove the lamp from the vial.
10. Fill a second vial (24 mm Ø) with **10 ml of the digested sample** (this is the sample).
11. Add the contents of **one Vario Phosphate Rgt. F10 Powder Pack** straight from the foil into each vial (blank and sample).
12. Close the vials tightly with the cap and swirl gently several times (30 sec.). (Note 6)

## 1.1 Methods

prepare Zero  
press ZERO

Countdown  
2:00

Zero accepted  
prepare Test  
press TEST

13. Place the vial (the blank) in the sample chamber making sure that the  $\Sigma$  marks are aligned.

14. Press **ZERO** key.

Wait for a **reaction period of 2 minutes** (Note 7).

After the reaction period is finished the measurement starts automatically.

15. Remove the vial from the sample chamber.

16. Place the vial (the sample) in the sample chamber making sure that the  $\Sigma$  marks are aligned.

17. Press **TEST** key.

The result is shown in the display in mg/L  $\text{PO}_4^{3-}$ .

To calculate the actual phosphonate concentration multiply the reading with the corresponding dilution factor from table 1.

To calculate the active phosphonate concentration multiply the actual phosphonate concentration using the appropriate factor from table 2.

### Notes:

1. Rinse all glassware with 1:1 Hydrochloric acid first and then rinse with deionised water. Do not use detergents with phosphates.
2. During UV digestion Phosphonates are converted to ortho-Phosphates. This step is normally completed in 10 minutes. High organic loaded samples or a weak lamp can cause incomplete phosphate conversion.
3. UV lamp available on request.
4. While the UV lamp is on UV safety goggles must be worn.
5. For handling of the UV lamp see manufacturer's manual. Do not touch the surface of the UV lamp. Fingerprints will etch the glass. Wipe the UV lamp with a soft and clean tissue between measurements.
6. The reagent does not dissolve completely.
7. The given reaction time of 2 minutes refers to a water sample temperature of more than 15°C. At a sample temperature lower than 15 °C a reaction time of 4 minutes is required.

### Tables and Reagent:

see next page

## 1.1 Methods

Table 1:

Expected range (mg/L Phosphonate)	Sample volume in ml	Factor
0 – 2.5	50	0.1
0 – 5.0	25	0.2
0 – 12.5	10	0.5
0 – 25	5	1.0
0 – 125	1	5.0

Table 2:

Phosphonate type	Conversion factor for active phosphonate
PBTC	2.840
NTP	1.050
HEDPA	1.085
EDTMPA	1.148
HMDTMPA	1.295
DETPMPA	1.207
HPA	1.490

Reagent / Accessories	Form of reagent/Quantity	Order-No.
<b>Set</b> VARIO Potassium F10 Persulfate VARIO PHOSPHATE RGT F10 PP	Powder Pack / 100 Powder Pack / 200	535220

## 1.1 Methods

Interference levels decrease with increasing sample volume.

Example: Iron interferes above 200 mg/L if a sample volume of 5 ml is used.

At a sample volume of 10 ml the interference level decreases to 100 mg/L.

**Table 3:**

<b>Interfering substances</b>	<b>Interference level using 5 ml of sample</b>
Aluminium	100 mg/l
Arsenate	interferes at all concentrations
Benzotriazole	10 mg/l
Bicarbonate	1000 mg/l
Bromide	100 mg/l
Calcium	5000 mg/l
CDTA	100 mg/l
Chloride	5000 mg/l
Chromate	100 mg/l
Copper	100 mg/l
Cyanide	100 mg/l; increase the UV digestion to 30 minutes
Diethanoldithiocarbamate	50 mg/l
EDTA	100 mg/l
Iron	200 mg/l
Nitrate	200 mg/l
NTA	250 mg/l
ortho-Phosphate	15 mg/l
Phosphite and organophosphorus compounds	reacts quantitatively; Meta- and Polyphosphates do not interfere
Silica	500 mg/l
Silicate	100 mg/l
Sulfate	2000 mg/l
Sulfide	interferes at all concentrations
Sulfite	100 mg/l
Thiourea	10 mg/l
highly buffered samples or extreme sample pH	may exceed the buffering capacity of the reagents and require sample pretreatment

## 1.1 Methods

3

2

9

### pH value LR 5.2 – 6.8 with Tablet



prepare Zero  
press ZERO

1. Fill a clean vial (24 mm Ø) with **10 ml of the water sample**, close tightly with the cap.
2. Place the vial in the sample chamber making sure that the X marks are aligned.
3. Press **ZERO** key.
4. Remove the vial from the sample chamber.
5. Add **one BROMOCRESOLPURPLE PHOTOMETER tablet** straight from the foil to the water sample and crush the tablet using a clean stirring rod.
6. Close the vial tightly with the cap and swirl several times until the tablet is dissolved.
7. Place the vial in the sample chamber making sure that the X marks are aligned.
8. Press **TEST** key.

Zero accepted  
prepare Test  
press TEST

The result is shown in the display as pH-value.



## 1.1 Methods

### Notes:

1. For photometric determination of pH values only use BROMOCRESOLPURPLE tablets in black printed foil pack and marked with PHOTOMETER.
2. pH values below 5.2 and above 6.8 can produce results inside the measuring range. A plausibility test (pH-meter) is recommended.
3. The accuracy of the colorimetric determination of pH-values depends on various boundary conditions (buffer capacity of the sample, salt contents etc.).
4. Salt error

Correction of test results (average values) for samples with salt contents of:

Indicator	Salt content		
Bromocresolpurple	1 molar - 0.26	2 molar - 0.33	3 molar - 0.31

The values of Parson and Douglas (1926) are based on the use of Clark and Lubs buffers.  
1 Mol NaCl = 58.4 g/l = 5.8 %

Reagent / Accessories	Form of reagent/Quantity	Order-No.
BROMOCRESOLPURPLE PHOTOMETER	Tablet / 100	515700BT

## 1.1 Methods

3 3 0

### pH value 6.5 – 8.4 with Tablet



prepare Zero  
press ZERO

1. Fill a clean vial (24 mm Ø) with **10 ml of the water sample**, close tightly with the cap.
2. Place the vial in the sample chamber making sure that the  $\Sigma$  marks are aligned.
3. Press **ZERO** key.
4. Remove the vial from the sample chamber.
5. Add **one PHENOL RED PHOTOMETER tablet** straight from the foil to the water sample and crush the tablet using a clean stirring rod.
6. Close the vial tightly with the cap and swirl several times until the tablet is dissolved.
7. Place the vial in the sample chamber making sure that the  $\Sigma$  marks are aligned.
8. Press **TEST** key.

Zero accepted  
prepare Test  
press TEST

The result is shown in the display as pH-value.

## 1.1 Methods

### Notes:

1. For photometric determination of pH-values only use PHENOL RED tablets in black printed foil pack and marked with PHOTOMETER.
2. Water samples with low values of Alkalinity-m (below 35 mg/l CaCO<sub>3</sub>) may give wrong pH readings.
3. pH-values below 6.5 and above 8.4 can produce results inside the measuring range. A plausibility test (pH-meter) is recommended.
4. Salt error

For salt concentrations below 2 g/l no significant error, due to the salt concentration of the reagent tablet, is expected. For higher salt concentrations the measurement values have to be adjusted as follows:

Salt content	30 g/l (seawater)	60 g/l	120 g/l	180 g/l
Correction	- 0,15 <sup>1)</sup>	- 0,21 <sup>2)</sup>	- 0,26 <sup>2)</sup>	- 0,29 <sup>2)</sup>

<sup>1)</sup> according to Kolthoff (1922)

<sup>2)</sup> according to Parson und Douglas (1926)

Reagent / Accessories	Form of reagent/Quantity	Order-No.
PHENOL RED PHOTOMETER	Tablet / 100	511770BT

## 1.1 Methods

3

3

1

### pH value 6.5 – 8.4 with Liquid Reagent



prepare Zero  
press ZERO

1. Fill a clean vial (24 mm Ø) with **10 ml of the water sample**, close tightly with the cap.
2. Place the vial in the sample chamber making sure that the  $\Sigma$  marks are aligned.
3. Press **ZERO** key.
4. Remove the vial from the sample chamber.
5. Fill the vial with drops of the same size by holding the bottle vertically and squeeze slowly:

#### 6 drops of PHENOL RED solution

6. Close the vial tightly with the cap and swirl several times to mix the contents.
7. Place the vial in the sample chamber making sure that the  $\Sigma$  marks are aligned.
8. Press **TEST** key.

Zero accepted  
prepare TEST  
press Test

The result is shown in the display as pH-value.

## 1.1 Methods

### Notes:

1. When testing chlorinated water the residual chlorine contents can influence the colour reaction of the liquid reagent. This can be avoided (without interfering with the pH measurement) by adding a small crystal of Sodiumthiosulfate ( $\text{Na}_2\text{S}_2\text{O}_3 \cdot 5 \text{H}_2\text{O}$ ) to the sample before adding the PHENOL RED solution. PHENOL RED tablets already contain Thiosulfate.
2. Due to differing drop sizes results can show a discrepancy in accuracy by comparison with tablets. This can be minimised by using a pipette (0.18 ml PHENOL RED solution is equivalent to 6 drops).
3. After use replace the bottle cap securely.

**4. Store the reagent in a cool, dry place ideally between 6°C and 10°C.**

5. Salt error

For higher salt concentrations the measurement values have to be adjusted as follows:

Salt content	30 g/l (seawater)	60 g/l	120 g/l	180 g/l
Correction	- 0,15 <sup>1)</sup>	- 0,21 <sup>2)</sup>	- 0,26 <sup>2)</sup>	- 0,29 <sup>2)</sup>

<sup>1)</sup> according to Kolthoff (1922)

<sup>2)</sup> according to Parson und Douglas (1926)

Reagent / Accessories	Form of reagent/Quantity	Order-No.
PHENOL RED solution	Liquid reagent / 15 ml	471040

## 1.1 Methods

3

3

2

### pH value HR 8.0 – 9.6 with Tablet



prepare Zero  
press ZERO

1. Fill a clean vial (24 mm Ø) with **10 ml of the water sample**, close tightly with the cap.
2. Place the vial in the sample chamber making sure that the X marks are aligned.
3. Press **ZERO** key.
4. Remove the vial from the sample chamber.
5. Add **one THYMOLBLUE PHOTOMETER tablet** straight from the foil to the water sample and crush the tablet using a clean stirring rod.
6. Close the vial tightly with the cap and swirl several times until the tablet is dissolved.
7. Place the vial in the sample chamber making sure that the X marks are aligned.
8. Press **TEST** key.

Zero accepted  
prepare TEST  
press Test

The result is shown in the display as pH-value.

## 1.1 Methods

### Notes:

1. For photometric determination of pH values only use THYMOLBLUE tablets in black printed foil pack and marked with PHOTOMETER.
2. pH values below 8.0 and above 9.6 can produce results inside the measuring range. A plausibility test (pH-meter) is recommended.
3. The accuracy of the colorimetric determination of pH values depends on various boundary conditions (buffer capacity of the sample, salt contents etc.).
4. Salt error

Correction of test results (average values) for samples with salt contents of:

Indicator	Salt content		
Thymolblue	1 molar - 0.22	2 molar - 0.29	3 molar - 0.34

The values of Parson and Douglas (1926) are based on the use of Clark and Lubs buffers.  
1 Mol NaCl = 58.4 g/l = 5.8 %

Reagent / Accessories	Form of reagent/Quantity	Order-No.
THYMOLBLUE PHOTOMETER	Tablet / 100	515710

## 1.1 Methods

3

3

8

### Polyacrylate with Liquid reagent

1 – 30 mg/l



1. Fill a clean vial (24 mm Ø) with **10 ml of the water sample**, close tightly with the cap.
2. Place the vial in the sample chamber making sure that the  $\Sigma$  marks are aligned.
3. Press **ZERO** key.
4. Remove the vial from the sample chamber.
5. Add **1 ml (25 drops) KS255 (Polyacrylate reagent 1)** to the water sample (note 1).
6. Close the vial tightly with the cap and swirl gently several times.
7. Add **1 ml (25 drops) KS256 (Polyacrylate reagent 2)** to the water sample (note 1).
8. Close the vial tightly with the cap and swirl gently several times.
9. Place the vial in the sample chamber making sure that the  $\Sigma$  marks are aligned.
10. Press **TEST** key.

Wait for a **reaction period of 10 minutes**

After the reaction period is finished the measurement starts automatically.

The result is shown in the display in mg/l Polyacrylic Acid 2'100 sodium salt.

prepare Zero  
press ZERO

Zero accepted  
prepare Test  
press TEST

Countdown  
10:00



## 1.1 Methods

### Notes:

1. Fill the vial with drops of the same size by holding the bottle vertically and squeeze slowly.
2. If little or no turbidity is present at correct dose concentrations, the sample will need a pre-concentration step in order to detect this level of polyacrylate/polymer. Carry out this procedure as directed then test the pre-concentrated sample as above (see next page).
3. Anomalous results occur when interferences are present as part of the product blend or from sample contaminants. In these instances follow the interference removal steps detailed below and test this treated sample as above (see next page).
4. This test has been calibrated using polyacrylic acid 2'100 sodium salt in the range 1-30 mg/l. Other polyacrylates/polymers will give differing responses and therefore the test range will vary.

Reagent / Accessories	Form of reagent/Quantity	Order-No.
<b>Set</b> KS255 (Polyacrylate Reagenz 1) KS256 (Polyacrylate Reagenz 2)	Liquid reagent / 65 ml Liquid reagent / 65 ml	<b>56R019165</b> 56L025565 56L025665

## 1.1 Methods

### Pre-Concentration

Pre-concentration uses exactly the same procedure as interference removal, except a greater volume of sample is used in step 1, instead of deionised/tap water.

For calculation of the original sample concentration a concentration factor should be considered:

If a 50 ml sample is used the concentration factor is  $20/50 = 0.4$

If a 100 ml sample is used the concentration factor is  $20/100 = 0.2$

This can be extended as required in order to concentrate the polyacrylate/polymer sufficiently for analysis.

### Example:

If the reading is 20 mg/l and 50 ml are taken for pre-concentration the original concentration should be calculated as  $20 * 0.4 = 8$  mg/l.

### Note:

Samples exceeding 10,000 TDS should be diluted prior to loading onto the cartridge. Take this dilution into consideration when working out the overall concentration factor.

### Cartridge Preparation

1. Remove the plunger of the 20 ml syringe from the barrel and attach the C18 cartridge.
2. Add 5 ml of KS336 (Propan-2-ol) to the syringe barrel, attach the plunger and pass dropwise through the cartridge. Discard the eluent to waste.
3. Remove plunger and fill the syringe barrel with 20 ml of deionised/tap water. Attach the plunger and pass dropwise through the cartridge. Discard the eluent to waste. The cartridge is now ready to be used/reused.

## 1.1 Methods

### Interference removal

1. Transfer exactly 20 ml of sample water to a 100 ml sample bottle and dilute to approximately 50-60 ml with deionised water or tap water.
2. Add drops of KS173 (2,4 Dinitrophenol) until a pale yellow colour is observed in the sample.
3. Add drops of KS183 (Nitric Acid) until the yellow colour **JUST** disappears.
4. Remove the plunger from the barrel of the 60ml plastic syringe and firmly attach the prepared C18 cartridge (see page 246) to the end of the barrel.
5. Transfer the 50-60 ml of sample from the bottle to the syringe barrel and attach the plunger. Depress the plunger and allow the sample to flow dropwise from the cartridge. Do not use excessive force to elute the sample quickly. **LEAVE THE C18 CARTRIDGE ATTACHED** and remove the plunger. Discard all of eluted sample to waste.
6. Using the 20 ml syringe, add exactly 20 ml of deionised/tap water to the 60 ml syringe barrel attached to the cartridge followed by 1 ml (25 drops) of KS255 (Polyacrylate Reagent 1). Gently swirl the syringe to mix.
7. Attach the plunger and depress. Collect the eluted sample in a clean vessel. Allow the sample to flow dropwise from the cartridge. Do not use excessive force to elute the sample quickly.
8. Add 10 ml of the eluted water sample into clean vial (24 mm Ø).
9. Using this vial perform the measurement of the method polyacrylate (see page 248).

Reagent / Accessories	Form of reagent/Quantity	Order-No.
KS336 (Propan-2-ol) C18-cartridge	Liquid reagent / 65 ml	56L033665 AS-K22811-KW
KS173 (2,4 Dinitrophenol)	Liquid reagent / 65 ml	56L017365
KS183 (Nitric Acid)	Liquid reagent / 65 ml	56L018365

## 1.1 Methods

3 4 0

### Potassium with Tablet

0.7 – 16 mg/l K



Ø 24 mm

prepare Zero  
press ZERO

1. Fill a clean vial (24 mm Ø) with **10 ml of the water sample**, close tightly with the cap.
2. Place the vial in the sample chamber making sure that the  $\Sigma$  marks are aligned.
3. Press **ZERO** key.
4. Remove the vial from the sample chamber.
5. Add **one Potassium T tablet** straight from the foil to the water sample and crush the tablet using a clean stirring rod.
6. Close the vial tightly with the cap and swirl several times until the tablet is dissolved.
7. Place the vial in the sample chamber making sure that the  $\Sigma$  marks are aligned.
8. Press **TEST** key.

Zero accepted  
prepare Test  
press TEST

The result is shown in the display in mg/l Potassium.

## 1.1 Methods

### Notes:

1. If Potassium is present a cloudy solution will appear.  
Single particles are not necessarily caused by Potassium.

Reagent / Accessories	Form of reagent/Quantity	Order-No.
Potassium T	Tablet / 100	515670

## 1.1 Methods

3

5

0

### Silica/Silicon dioxide with Tablet

0.05 – 4 mg/l SiO<sub>2</sub>



prepare Zero  
press ZERO

1. Fill a clean vial (24 mm Ø) with **10 ml of the water sample**, close tightly with the cap.
2. Place the vial in the sample chamber making sure that the X marks are aligned.

3. Press **ZERO** key.

4. Remove the vial from the sample chamber.

5. Add **one SILICA No. 1 tablet** straight from the foil to the water sample and crush the tablet using a clean stirring rod.

6. Close the vial tightly with the cap and swirl several times until the tablet is dissolved.

Countdown  
5:00  
start: ↻

7. Press [↻] key.  
Wait for a **reaction period of 5 minutes**.

After the reaction period is finished proceed as follows:

8. Add **one SILICA PR tablet** straight from the foil to the same water sample and crush the tablet using a clean stirring rod.

9. Add **one SILICA No. 2 tablet** straight from the foil to the same water sample and crush the tablet using a clean stirring rod.

10. Close the cap tightly and swirl several times until the tablets are dissolved.

## 1.1 Methods

11. Place the vial in the sample chamber making sure that the  $\Sigma$  marks are aligned.

Zero accepted  
prepare Test  
press TEST

12. Press **TEST** key.

Wait for a **reaction period of 2 minutes**.

Countdown  
2:00

After the reaction period is finished the measurement starts automatically.

The result is shown in the display in mg/l Silica.

### Notes:

1. The tablets must be added in the correct sequence.
2. Phosphate ions do not interfere under the given reaction conditions.
3. Conversion:  
 $\text{mg/l Si} = \text{mg/l SiO}_2 \times 0.47$
4.  $\blacktriangle \text{SiO}_2$   
 $\blacktriangledown \text{Si}$

Reagent / Accessories	Form of reagent/Quantity	Order-No.
<b>Set</b> SILICA No. 1 / No. 2	Tablet / per 100 inclusive stirring rod	517671BT
SILICA No. 1	Tablet / 100	513130BT
SILICA No. 2	Tablet / 100	513140BT
SILICA PR	Tablet / 100	513150BT

## 1.1 Methods

3

5

1

### Silica LR / Silicon dioxide LR with Vario Powder Pack and Liquid Reagent

0.1 – 1.6 mg/l SiO<sub>2</sub>



Ø 24 mm

Use two clean vials (24 mm Ø) and mark one as blank for zeroing.

1. Fill each vial with **10 ml of the water sample**.
2. Add **0.5 ml Vario Molybdate 3 reagent solution** into each vial.
3. Close the vials tightly with the caps and swirl several times to mix the contents (Note 1).

#### Countdown

4:00

start: ↓

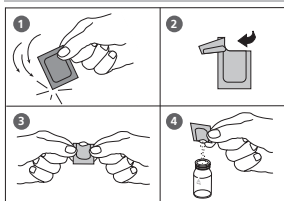

4. Press **[↓]** key.  
Wait for a **reaction period of 4 minutes** (Note 2).  
After the reaction period is finished proceed as follows:
5. Add the contents of **one Vario Silica Citric Acid F10 Powder Pack** straight from the foil into each vial.
6. Close the vials tightly with the caps and swirl several times to mix the contents.

#### Countdown

1:00

start: ↓

7. Press **[↓]** key.  
Wait for a **reaction period of 1 minute** (Note 3).  
After the reaction period is finished proceed as follows:
8. Place the vial (the blank) in the sample chamber making sure that the **X** marks are aligned.
9. Add the contents of **one Vario LR Silica Amino Acid F F10 Powder Pack** straight from the foil into the vial (the sample).
10. Close the vial tightly with the cap and swirl several times to mix the contents.



## 1.1 Methods

prepare Zero  
press ZERO

Countdown  
2:00

Zero accepted  
prepare Test  
press TEST

- Press **ZERO** key (blank is already placed in the sample chamber – see point 8).

Wait for a **reaction period of 2 minutes**.

After the reaction period is finished the zero-reading starts automatically.

- Remove the vial from the sample chamber.
- Place the vial (the sample) in the sample chamber making sure that the  $\Sigma$  marks are aligned.
- Press **TEST** key.

The result is shown in the display in mg/l Silica.

### Notes:

- Close the vials with the cap immediately after adding the Vario Molybdate 3 reagent solution, otherwise low readings may result.
- The given reaction time of 4 minutes refers to a water sample temperature of 20°C. At 30°C a reaction time of 2 minutes, at 10°C a reaction time of 8 minutes are required.
- The given reaction time of 1 minute refers to a water sample temperature of 20°C. At 30°C a reaction time of 30 seconds, at 10°C a reaction time of 2 minutes are required.
- Interferences:

Substance	Interference
Iron	large amounts interfere
Phosphate	does not interfere at concentrations less than 50 mg/l PO <sub>4</sub> at 60 mg/l PO <sub>4</sub> the interference is approx. – 2% at 75 mg/l PO <sub>4</sub> the interference is approx. – 11%
Sulfide	interferes at all levels

Occasionally water samples contain forms of silica which reacts very slowly with Molybdate. The nature of these forms is not known.

A pre-treatment with Sodium hydrogencarbonate and then with Sulfuric Acid will make these forms reactive to Molybdate (pre-treatment is given in "Standard Methods for the Examination of Water and Wastewater" under "Silica Digestion with Sodium Bicarbonate").

- $\blacktriangle$  SiO<sub>2</sub>  
 $\blacktriangledown$  Si

Reagent / Accessories	Form of reagent/Quantity	Order-No.
<b>Set</b> VARIO LR Silica Amino Acid F10 VARIO Silica Citric Acid F10 VARIO Molybdate 3	Powder Pack / 100 Powder Pack / 200 Liquid reagent / 2x 50 ml	535690

## 1.1 Methods

3

5

2

### Silica HR / Silicon dioxide HR with Vario Powder Pack

1 – 90 mg/l SiO<sub>2</sub>



prepare Zero  
press ZERO

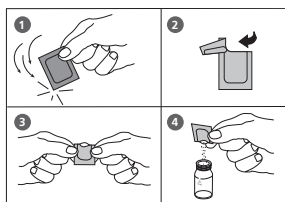

Countdown  
10:00  
start: ↙

Zero accepted  
prepare Test  
press TEST

Countdown  
2:00

1. Fill a clean vial (24 mm Ø) with **10 ml of the water sample** (Note 1), close tightly with the cap.
2. Place the vial in the sample chamber making sure that the  $\Sigma$  marks are aligned.
3. Press **ZERO** key.
4. Remove the vial from the sample chamber.
5. Add the contents of **one Vario Silica HR Molybdate F10 Powder Pack** straight from the foil to the water sample.
6. Close the vial tightly with the cap and swirl several times to mix the contents.
7. Add the contents of **one Vario Silica HR Acid Rgt. F10 Powder Pack** straight from the foil to the same water sample (Note 2).
8. Close the vial tightly with the cap and swirl several times to mix the contents.
9. Press **[ $\Sigma$ ]** key.  
Wait for a **reaction period of 10 minutes**.

After the reaction period is finished proceed as follows:

10. Add the contents of **one Vario Silica Citric Acid F10 Powder Pack** straight from the foil to the water sample (Note 3).
11. Close the vial tightly with the cap and swirl several times to mix the contents.
12. Place the vial in the sample chamber making sure that the  $\Sigma$  marks are aligned.
13. Press **TEST** key.

Wait for a **reaction period of 2 minutes**.

After the reaction period is finished the measurement starts automatically.

The result is shown in the display in mg/l Silica.

## 1.1 Methods

### Notes:

1. Temperature of the sample should be 15°C – 25°C.
2. If Silica or Phosphate is present a yellow colour is developed
3. In this step any yellow colour due to Phosphate is removed.
4. Interferences:

Substance	Interference
Iron	large amounts interfere
Phosphate	does not interfere at concentrations less than 50 mg/l PO <sub>4</sub> at 60 mg/l PO <sub>4</sub> the interference is approx. – 2% at 75 mg/l PO <sub>4</sub> the interference is approx. – 11 %
Sulfide	interferes at all levels

Occasionally water samples contain forms of silica which reacts very slowly with Molybdate. The nature of these forms is not known.

A pre-treatment with Sodium hydrogencarbonate and then with Sulfuric Acid will make these forms reactive to Molybdate (pre-treatment is given in "Standard Methods for the Examination of Water and Wastewater" under "Silica Digestion with Sodium Bicarbonate").

5.  $\blacktriangle$  SiO<sub>2</sub>  
 $\blacktriangledown$  Si

Reagent / Accessories	Form of reagent/Quantity	Order-No.
<b>Set</b> VARIO Silica HR Molybdate F10 VARIO Silica HR Acid Rgt F10 VARIO Silica HR Citric Acid F10	Powder Pack / 100 Powder Pack / 100 Powder Pack / 100	535700

## 1.1 Methods

3

5

3

### Silica / Silicon dioxide with Liquid reagent and powder

0.1 – 8 mg/l SiO<sub>2</sub>



Ø 24 mm

prepare Zero  
press ZERO

1. Fill a clean vial (24 mm Ø) with **10 ml of the water sample**, close tightly with the cap.
2. Place the vial in the sample chamber making sure that the X marks are aligned.

3. Press **ZERO** key.

4. Remove the vial from the sample chamber.

5. Fill the vial with drops of the same size by holding the bottle vertically and squeeze slowly:

**20 drops KS104 (Silica Reagent 1)**

6. Close the vial tightly with the cap and swirl several times to mix the contents.

Countdown  
5:00

7. Wait for a **reaction period of 5 minutes**.

8. Fill the vial with drops of the same size by holding the bottle vertically and squeeze slowly:

**20 drops KS105 (Silica Reagent 2)**

9. Close the vial tightly with the cap and swirl several times to mix the contents.

10. Add **1 level spoon of reagent KP106 (Silica Reagent 3)** (note 1).

11. Close the vial tightly with the cap and swirl several times to dissolve the powder.

## 1.1 Methods

Zero accepted  
press ZERO  
press TEST

Countdown  
10:00

12. Place the vial in the sample chamber making sure that the  $\times$  marks are aligned.

13. Press **TEST** key.

Wait for a **reaction period of 10 minutes**.

After the reaction period is finished the measurement starts automatically.

The result is shown in the display in mg/l Silica.

### Notes:

1. For correct dosage the spoon supplied with the reagents must be used.
2. For accurate results, ensure that the water being tested is between 20 °C and 30 °C.
3. At temperatures under 20°C the reaction does not proceed to completion and low results are obtained.
4. ▲ SiO<sub>2</sub>  
▼ Si

Reagent / Accessories	Form of reagent/Quantity	Order-No.
KS104 – Silica Reagent 1	Liquid reagent / 65 ml	56L010465
KS105 – Silica Reagent 2	Liquid reagent / 65 ml	56L010565
KP106 – Silica Reagent 3	Powder / 10 g	56P010610

## 1.1 Methods



### Sodium hypochlorite (Soda bleaching lye) with Tablet

0.2 – 16 % w/w NaOCl

#### Preparation:

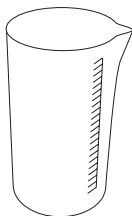

1. Fill a 5 ml plastic syringe with the test solution, ensuring that all air bubbles are expelled. Transfer the 5 ml test solution slowly into a 100 ml beaker and dilute to the 100 ml mark with chlorine-free water. Mix thoroughly.
2. Fill a 5 ml plastic syringe with the diluted test solution (step 1) to the 1 ml mark, ensuring that all air bubbles are expelled. Transfer the 1 ml test solution slowly into a 100 ml beaker and dilute to the 100 ml mark with chlorine-free water. Mix thoroughly.

#### Performing test procedure:



1. Fill a clean vial (24 mm Ø) with **10 ml of the prepared water sample**, close tightly with the cap.
2. Place the vial in the sample chamber making sure that the  $\Sigma$  marks are aligned.
3. Press **ZERO** key.
4. Remove the vial from the sample chamber.
5. Add **one CHLORINE HR (KI) tablet** straight from the foil to the water sample and crush the tablet using a clean stirring rod.
6. Add **one ACIDIFYING GP tablet** straight from the foil to the same water sample and crush the tablet using a clean stirring rod.
7. Close the vial tightly with the cap and swirl several times until the tablets are dissolved.

prepare Zero  
press ZERO

## 1.1 Methods

- Place the vial in the sample chamber making sure that the  $\bar{X}$  marks are aligned.

**Zero accepted  
prepare Test  
press TEST**

- Press **TEST** key.

The result is shown in the display in % w/w as available chlorine present in the original sample of Sodium hypochlorite.

### Notes:

- Please pay attention when handling sodium hypochlorite. The material has a very strong alkalinity and can cause corrosion. Contact with eyes, skin and clothes etc. has to be avoided. Refer to the detailed information the producer supplied with the product.
- The tablets must be added in the correct sequence.
- This method provides a fast and simple test. The test can be performed on site but the result will not be as precise as a laboratory method.
- By strictly following the test procedure, an accuracy of +/- 1 weight % can be achieved.

Reagent / Accessories	Form of reagent/Quantity	Order-No.
<b>Set</b> ACIDIFYING GP/ CHLORINE HR (KI)	Tablet / per 100 inclusive stirring rod	517721BT
CHLORINE HR (KI)	Tablet / 100	513000BT
ACIDIFYING GP	Tablet / 100	515480BT

## 1.1 Methods

3

5

5

### Sulfate with Tablet

5 – 100 mg/l SO<sub>4</sub>



1. Fill a clean vial (24 mm Ø) with **10 ml of the water sample**, close tightly with the cap.
2. Place the vial in the sample chamber making sure that the  $\Sigma$  marks are aligned.

prepare Zero  
press ZERO

3. Press **ZERO** key.
4. Remove the vial from the sample chamber.
5. Add **one SULFATE T tablet** straight from the foil to the water sample and crush the tablet using a clean stirring rod.
6. Close the vial tightly with the cap and swirl several times until the tablet is dissolved.
7. Place the vial in the sample chamber making sure that the  $\Sigma$  marks are aligned.

Zero accepted  
prepare Test  
press TEST

Countdown  
2:00

8. Press **TEST** key.  
Wait for a **reaction period of 2 minutes**.

After the reaction period is finished the measurement starts automatically.

The result is shown in the display in mg/l Sulfate.



## 1.1 Methods

**Notes:**

1. If Sulfate is present a cloudy solution will appear.

Reagent / Accessories	Form of reagent/Quantity	Order-No.
SULFATE T	Tablet / 100	515450BT

## 1.1 Methods

3 6 0

### Sulfate with Vario Powder Pack

5 – 100 mg/l SO<sub>4</sub>



Ø 24 mm

prepare Zero  
press ZERO

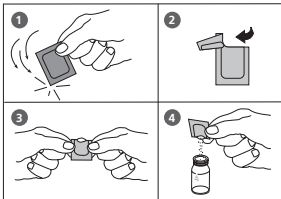

Zero accepted  
prepare Test  
press TEST

Countdown  
5:00

1. Fill a clean vial (24 mm Ø) with **10 ml of the water sample**, close tightly with the cap.
2. Place the vial in the sample chamber making sure that the X marks are aligned.
3. Press **ZERO** key.
4. Remove the vial from the sample chamber.
5. Add the contents of **one VARIO Sulpha 4/ F10 Powder Pack** straight from the foil to the water sample.
6. Close the vial tightly with the cap and swirl several times to mix the contents.
7. Place the vial in the sample chamber making sure that the X marks are aligned.
8. Press **TEST** key.  
Wait for a **reaction period of 5 minutes**.

After the reaction period is finished the measurement starts automatically.

The result is shown in the display in mg/l Sulfate.

## 1.1 Methods

**Note:**

1. If Sulfate ions are present a cloudy solution will appear.

<b>Reagent / Accessories</b>	<b>Form of reagent/Quantity</b>	<b>Order-No.</b>
VARIO Sulpha 4 / F10	Powder Pack / 100	532160

## 1.1 Methods

3

6

5

### Sulfide with Tablet

0.04 – 0.5 mg/l S



Ø 24 mm

prepare Zero  
press ZERO

1. Fill a clean vial (24 mm Ø) with **10 ml of the water sample**, close tightly with the cap.
2. Place the vial in the sample chamber making sure that the  $\Sigma$  marks are aligned.
3. Press **ZERO** key.

4. Remove the vial from the sample chamber.
5. Add **one SULFIDE No. 1 tablet** to the water sample and crush the tablet using a clean stirring rod and dissolve the tablet.
6. Add **one SULFIDE No. 2 tablet** to the same water sample and crush the tablet using a clean stirring rod.
7. Close the vial tightly with the cap and swirl several times until the tablets are dissolved.
8. Place the vial in the sample chamber making sure that the  $\Sigma$  marks are aligned.

Zero accepted  
prepare Test  
press TEST

Countdown  
10:00

9. Press **TEST** key.  
Wait for a **reaction period of 10 minutes**.

After the reaction period is finished the measurement starts automatically.

The result is shown in the display in mg/l Sulfide.

## 1.1 Methods

### Notes:

1. The tablets must be added in the correct sequence.
2. Chlorine and other oxidizing agents which react with DPD do not interfere with the test.
3. To avoid loss of Sulfide collect the sample carefully with a minimum of aeration. It is essential to test the sample immediately after collection.
4. The sample temperature should be 20°C. A different temperature can lead to higher or lower results.
5. Conversion:  
$$H_2S = \text{mg/l S} \times 1.06$$
6. ▲ S  
▼ H<sub>2</sub>S

Reagent / Accessories	Form of reagent/Quantity	Order-No.
SULFIDE No. 1	Tablet / 100	502930
SULFIDE No. 2	Tablet / 100	502940

## 1.1 Methods

3 7 0

### Sulfite with Tablet

0.1 – 5 mg/l SO<sub>3</sub>



1. Fill a clean vial (24 mm Ø) with **10 ml of the water sample**, close tightly with the cap.
2. Place the vial in the sample chamber making sure that the **X** marks are aligned.
3. Press **ZERO** key.
4. Remove the vial from the sample chamber.
5. Add **one SULFITE LR tablet** straight from the foil to the water sample and crush the tablet using a clean stirring rod.
6. Close the vial tightly with the cap and swirl several times until the tablet is dissolved.
7. Place the vial in the sample chamber making sure that the **X** marks are aligned.

prepare Zero  
press ZERO

8. Press **TEST** key.

Wait for a **reaction period of 5 minutes**.

After the reaction period is finished the measurement starts automatically.

The result is shown in the display in mg/l Sulfite.

Zero accepted  
prepare Test  
press TEST

Countdown  
5:00

## 1.1 Methods

**Notes:**

1. ▲  $\text{SO}_3$   
▼  $\text{Na}_2\text{SO}_3$

Reagent / Accessories	Form of reagent/Quantity	Order-No.
SULFITE LR	Tablet / 100	518020BT

## 1.1 Methods

3 7 6

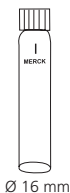

### Surfactants, anionic with MERCK Spectroquant® Cell Test, No. 1.02552.0001

0.05 – 2 mg/l SDSA<sup>1)</sup>  
0.06 – 2.56 mg/l SDBS<sup>2)</sup>  
0.05 – 2.12 mg/l SDS<sup>3)</sup>  
0.08 – 3.26 mg/l SDOSSA<sup>4)</sup>

Use two clean Reagent tubes and mark one as blank for zeroing.

1. Add **5 ml deionised water** in the vial marked as blank (**this is the blank, note 6**). **Do not mix contents!**
2. Fill the second prepared vial with **5 ml of the water sample (this is the sample, note 6)**. **Do not mix contents!**
3. Fill each vial with drops of the same size by holding the bottle vertically and squeeze slowly:  
**2 drops reagent T-1K**
4. Close the vials tightly with the caps and **shake vigorously for 30 seconds**.

Countdown  
10:00  
start: ↴

5. Press **[↴]** key.  
Wait for a **reaction period of 10 minutes**.  
After the reaction period is finished proceed as follows:
6. **Swirl the vial (the blank)** and then place the vial (**the blank**) in the sample chamber making sure that the marks  are aligned. (**note 7**)

prepare Zero  
press ZERO

7. Press **ZERO** key.
8. Remove the vial from the sample chamber.



## 1.1 Methods

9. **Swirl the vial (the sample)** and then place the vial **(the sample)** in the sample chamber making sure that the marks  are aligned. **(note 7)**

**Zero accepted  
prepare Test  
press TEST**

10. Press **TEST** key.

The result is shown in the display in mg/l SDSA.

### Notes:

1. This method is adapted from MERCK.
2. Before performing the test read the original test instructions (delivered with the test) and the MSDS (available at [www.merckmillipore.com](http://www.merckmillipore.com)).
3. Spectroquant® is a registered trade mark of the company MERCK KGaA.
4. Appropriate safety precautions and good lab technique should be used during the whole procedure.
5. Because reaction depends on temperature, tube temperature must be between **15 and 20°C**; sample temperature must be between **10 and 20°C**.
6. Sample volume should always be metered by using volumetric pipette (class A).
7. Should the lower phase be turbid, warm the cell briefly with the hand.
8. The test sample should have a pH value between 5 and 10.
9. ▲ SDSA<sup>1)</sup>  
    SDBS<sup>2)</sup>  
    SDS<sup>3)</sup>  
    ▼ SDOSSA<sup>4)</sup>

Reagent / Accessories	Form of reagent/Quantity	Order-No.
MERCK Spectroquant® 1.02552.0001	Cell Test / 25 Tests	420763

<sup>1)</sup> calculated as sodium 1-dodecanesulfonate (APHA 5540, ASTM 2330-02, ISO 7875-1)

<sup>2)</sup> calculated as sodium dodecylbenzenesulfonate (EPA 425.1)

<sup>3)</sup> calculated as sodium dodecyl sulfate

<sup>4)</sup> calculated as Sodium dioctyl sulfosuccinate

## 1.1 Methoden

3 7 7

### Surfactants, nonionic with MERCK Spectroquant® Cell Test, No. 1.01787.0001

0.1 – 7.5 mg/l Triton® X-100

0.11 – 8.25 mg/l NP 10



Use two clean Reagent tubes and mark one as blank for zeroing.

1. Add **4 ml deionised water** in the vial marked as blank (**this is the blank, note 6**).
2. Fill the second prepared vial with **4 ml of the water sample (this is the sample, note 6)**.
3. Close the vials tightly with the caps and shake vigorously for **1 minute**.

Countdown  
2:00  
start: ↵

4. Press **[↵]** key.

Wait for a **reaction period of 2 minutes**.

After the reaction period is finished proceed as follows:

5. **Swirl the vial (the blank)** and then place the vial (**the blank**) in the sample chamber making sure that the marks  are aligned.

prepare Zero  
press ZERO

6. Press **ZERO** key.

7. Remove the vial from the sample chamber.

8. **Swirl the vial (the sample)** and then place the vial (**the sample**) in the sample chamber making sure that the marks  are aligned.

Zero accepted  
prepare Test  
press TEST

9. Press **TEST** key.

The result is shown in the display in mg/l Triton® X-100.

## 1.1 Methoden

### Notes:

1. This method is adapted from MERCK.
2. Before performing the test read the original test instructions (delivered with the test) and the MSDS (available at [www.merckmillipore.com](http://www.merckmillipore.com)).
3. Spectroquant® is a registered trade mark of the company MERCK KGaA.
4. Appropriate safety precautions and good lab technique should be used during the whole procedure.
5. Because reaction depends on temperature, sample and tube temperature must be between **20 and 25°C**.
6. Sample volume should always be metered by using volumetric pipette (class A).
7. The test sample should have a pH value between 3 and 9.
8. Triton® is a registered trade mark of the company DOW Chemical Company.
9. ▲ Triton® X-100  
▼ NP 10

Reagent / Accessories	Form of reagent/Quantity	Order-No.
MERCK Spectroquant® 1.01787.0001	Cell Test / 25 Tests	420764

<sup>1)</sup> Nonylphenol Ethoxylat

## 1.1 Methods

3

7

8

### Surfactants, cationic with MERCK Spectroquant® Cell Test, No. 1.01764.0001

0.05 – 1.5 mg/l CTAB



Use two clean Reagent tubes and mark one as blank for zeroing.

1. Add **5 ml deionised water** in the vial marked as blank **(this is the blank, note 6). Do not mix contents!**
2. Fill the second prepared vial with **5 ml of the water sample (this is the sample, note 6). Do not mix contents!**
3. Pipette **0.5 ml reagent T-1K** into each vial. **(note 6)**
4. Close the vials tightly with the caps and swirl for **30 seconds**.

Countdown  
5:00  
start: ↵

5. Press **↵** key.

Wait for a **reaction period of 5 minutes**.

After the reaction period is finished proceed as follows:

6. Place the vial **(the blank)** in the sample chamber making sure that the marks **Δ** are aligned. **(note 9)**
7. Press **ZERO** key.
8. Remove the vial from the sample chamber.
9. Place the vial **(the sample)** in the sample chamber making sure that the marks **Δ** are aligned. **(note 9)**
10. Press **TEST** key.

The result is shown in the display in mg/l CTAB.

prepare Zero  
press ZERO

Zero accepted  
prepare Test  
press TEST

## 1.1 Methods

### Notes:

1. This method is adapted from MERCK.
2. Before performing the test read the original test instructions (delivered with the test) and the MSDS (available at [www.merckmillipore.com](http://www.merckmillipore.com)).
3. Spectroquant® is a registered trade mark of the company MERCK KGaA.
4. Appropriate safety precautions and good lab technique should be used during the whole procedure.
5. Because reaction depends on temperature, sample and tube temperature must be between **20 and 25°C**.
6. Sample volume should always be metered by using volumetric pipette (class A).
7. CTAB = calculated as N-cetyl-N,N,N-trimethylammonium bromide
8. The test sample should have a pH value between 3 and 8.
9. Should the lower phase be turbid, warm the cell briefly with the hand.

Reagent / Accessories	Form of reagent/Quantity	Order-No.
MERCK Spectroquant® 1.01764.0001	Cell Test / 25 Tests	420765

## 1.1 Methods

3

8

4

### Suspended Solids

0 – 750 mg/l TSS



Ø 24 mm

#### Sample preparation:

Blend approx. 500 ml of the water sample in a blender at high speed for 2 minutes.

1. Fill a clean vial (24 mm Ø) with **10 ml of deionised water**, close tightly with the cap.

2. Place the vial in the sample chamber making sure that the  $\Sigma$  marks are aligned.

prepare Zero  
press ZERO

3. Press **ZERO** key.

4. Remove the vial from the sample chamber and empty the vial completely.

5. Stir the blended water sample. Immediately rinse the vial with the water sample and fill with **10 ml water sample**.

6. Place the vial in the sample chamber making sure that the  $\Sigma$  marks are aligned.

Zero accepted  
prepare Test  
press TEST

7. Press **TEST** key.

The result is shown in the display in mg/l TSS (Total Suspended Solids).

## 1.1 Methods

### Note:

1. The photometric determination of Suspended Solids is based on a gravimetric method.  
In a lab this is usually done by evaporation of the filter residue of a filtrated water sample in an oven at 103°C – 105°C and weighing of the dried residue.
2. When higher accuracy is required perform a gravimetric determination of a water sample. The result can be used to calibrate the photometer with the same water sample.
3. The estimated detection limit is 20 mg/L TSS.
4. Collect water samples in clean plastic or glass bottles and analyse the water sample as soon as possible. It is possible to store the sample at 4°C for 7 days. Before measurement warm up the sample to the temperature at collection time.
5. Interferences:
  - Air bubbles interfere and can be removed by swirling the vial gently.
  - Colour interferes if light is absorbed at 660 nm.

## 1.1 Methods



### TOC LR with MERCK Spectroquant® Cell Test, No. 1.14878.0001

5.0 – 80.0 mg/l TOC

Use two clean suitable glass containers and mark one as blank for zeroing.

1. Fill a clean glass container with **25 ml of deionised water** (this is the **blank**).
2. Fill the other clean glass container with **25 ml of the water sample** (this is the **sample**).
3. Fill each glass container with drops of the same size by holding the bottle vertically and squeeze slowly:  
**3 drops reagent TOC-1K** and mix.
4. pH value of the solution must be below 2.5.  
If necessary adjust the pH with sulphuric acid.
5. Stir for **10 minutes** at medium speed (magnetic stirrer, stirring staff).

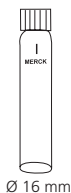

#### Digestion:

Use two clean reaction tubes (16 mm Ø) and mark one as **blank** for zeroing.

6. Pipette **3 ml pre-prepared blank** into one reaction tube (blank).
7. Pipette **3 ml pre-prepared sample** into one reaction tube (sample).
8. Add **1 level microspoon of reagent TOC-2K** to each reaction tube.
9. **Immediately** close the vials tightly with an aluminium cap.



## 1.1 Methods

- Heat vials, **standing on its head**, at **120°C** in the pre-heated reactor for **120 minutes**.
- Wait for 1 hour before proceeding.  
**Do not cool down with water!** After cooling, turn the cell upright and measure in the photometer **within 10 min**.

### Performing test procedure:

Insert the adapter for 16 mm Ø vials.

- Place the cooled down blank in the sample chamber making sure that the marks  $\times$  are aligned.

**prepare Zero  
press ZERO**

- Press **ZERO** key.
- Remove the vial from the sample chamber.
- Place the cooled down sample in the sample chamber making sure that the marks  $\times$  are aligned.

**Zero accepted  
prepare Test  
press TEST**

- Press **TEST** key.  
The result is shown in the display in mg/l TOC.

### Notes:

- This method is adapted from MERCK.
- Before performing the test read the original test instructions (delivered with the test) and the MSDS (available at [www.merckmillipore.com](http://www.merckmillipore.com)).
- Spectroquant® is a registered trade mark of the company MERCK KGaA.
- Appropriate safety precautions and good lab technique should be used during the whole procedure.
- Sample volume should always be metered by using volumetric pipette (class A).
- TOC = **T**otal **O**rganic **C**arbon

Reagent / Accessories	Form of reagent/Quantity	Order-No.
MERCK Spectroquant® 1.14878.0001	Cell Test / 25 tests	420756
Screw caps 1.73500.0001	6 units	420757

## 1.1 Methods

3

8

1

### TOC HR with MERCK Spectroquant® Cell Test, No. 1.14879.0001

50 – 800 mg/l TOC

Use two clean suitable glass containers and mark one as blank for zeroing.

1. Fill a clean glass container with **10 ml of deionised water** (this is the **blank**).
2. Fill the other clean glass container with **1 ml of the water sample**. Add **9 ml deionised water** and mix (this is the **sample**).
3. Fill each glass container with drops of the same size by holding the bottle vertically and squeeze slowly:  
**2 drops reagent TOC-1K** and mix.
4. pH value of the solution must be below 2.5.  
If necessary adjust the pH with sulphuric acid.
5. Stir for **10 minutes** at medium speed (magnetic stirrer, stirring staff).

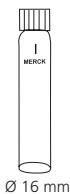

Ø 16 mm

#### Digestion:

Use two clean reaction tubes (16 mm Ø) and mark one as **blank** for zeroing.

6. Pipette **3 ml pre-prepared blank** into one reaction tube (blank).
7. Pipette **3 ml pre-prepared sample** into one reaction tube (sample).
8. Add **1 level microspoon of reagent TOC-2K to each** reaction tube.

## 1.1 Methods

9. **Immediately** close the vials tightly with an aluminium cap.
10. Heat vials, **standing on its head**, at **120°C** in the pre-heated reactor for **120 minutes**.
11. Wait for 1 hour before proceeding.  
**Do not cool down with water!** After cooling, turn the cell upright and measure in the photometer **within 10 min**.

### Performing test procedure:

Insert the adapter for 16 mm Ø vials.

10. Place the cooled down blank in the sample chamber making sure that the marks  $\times$  are aligned.
11. Press **ZERO** key.
12. Remove the vial from the sample chamber.
13. Place the cooled down sample in the sample chamber making sure that the marks  $\times$  are aligned.

prepare Zero  
press ZERO

14. Press **TEST** key.

The result is shown in the display in mg/l TOC.

Zero accepted  
prepare Test  
press TEST

### Notes:

1. This method is adapted from MERCK.
2. Before performing the test read the original test instructions (delivered with the test) and the MSDS (available at [www.merckmillipore.com](http://www.merckmillipore.com)).
3. Spectroquant® is a registered trade mark of the company MERCK KGaA.
4. Appropriate safety precautions and good lab technique should be used during the whole procedure.
5. Sample volume should always be metered by using volumetric pipette (class A).
6. TOC = Total **O**rganic **C**arbon

Reagent / Accessories	Form of reagent/Quantity	Order-No.
MERCK Spectroquant® 1.14879.0001	Cell Test / 25 tests	420756
Screw caps 1.73500.0001	6 units	420757

## 1.1 Methods

3

8

8

### Tolyltriazole Benzotriazole / Triazole with Vario Powder Pack

1 – 16 mg/l / 1.1 – 17.8

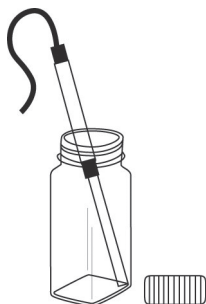

1. Transfer **25 ml of the water sample** into the digestion vial.
2. Add the contents of **one Vario Triazole Rgt Powder Pack F25** straight from the foil into the water sample (note 1).
3. Close the digestion vial tightly with the cap and swirl until the reagent is dissolved completely.
4. Insert the UV lamp into the digestion vial (notes 1, 2, 3).  
**CAUTION: Wear UV safety goggles!**

5. Switch the UV lamp on

6. Press [↵] key.

**Wait for a reaction period of 5 minutes** (notes 10, 11).

After the reaction period is finished proceed as follows:

7. Switch the UV lamp off and remove the lamp from the vial.

8. Invert several times to mix the contents.

9. Fill a clean vial (24 mm Ø) with **10 ml of the deionised water**, close tightly with the cap.

10. Place the vial in the sample chamber making sure that the X marks are aligned.

Countdown 1  
5:00  
start: ↵



Ø 24 mm

## 1.1 Methods

11. Press **ZERO** key.

**prepare Zero  
press ZERO**

12. Remove the vial from the sample chamber and empty the vial.

13. Add the digested water sample to the 10 ml mark.

14. Place the vial in the sample chamber making sure that the  $\Sigma$  marks are aligned.

15. Press **TEST** key.

**Zero accepted  
prepare Test  
press TEST**

The result is shown in the display in mg/L Benzotriazole or Tolyltriazole (note 4).

#### Notes:

1. UV lamp and Triazole Powder Pack available on request.
2. While the UV lamp is on UV safety goggles must be worn.
3. For handling of the UV lamp see manufacturer's manual.  
Do not touch the surface of the UV lamp. Fingerprints will etch the glass.  
Wipe the UV lamp with a soft and clean tissue between measurements.
4. The test will not distinguish between benzotriazole and tolyltriazole.
5. The analysis should take place immediately after taking the sample.
6. Strong oxidising or reducing agents in the vial lead to incorrect measurements.
7. To get accurate results the sample temperature must be between 20°C and 25°C.
8. If sample contains nitrite or borax (sodium borate), adjust the pH between 4 and 6 with 1 N sulfuric acid.
9. If the sample contains more than 500 mg/l CaCO<sub>3</sub> hardness (CaCO<sub>3</sub>), add 10 drops of Rochelle Salt Solution.
10. A yellow colour will form if Triazol is present.
11. Low results will occur if photolysis (lamp on) takes place for more than or less than five minutes.
12. ▲ Benzotriazole  
▼ Tolyltriazole

Reagent / Accessories	Form of reagent/Quantity	Order-No.
VARIO TRIAZOLE Rgt F25	Powder Pack / 100	532200

## 1.1 Methods

3 8 6

### Turbidity

10 – 1000 FAU



prepare Zero  
press ZERO

1. Fill a clean vial (24 mm Ø) with **10 ml of deionised water**, close tightly with the cap.
2. Place the vial in the sample chamber making sure that the  $\Sigma$  marks are aligned.
3. Press **ZERO** key.
4. Remove the vial from the sample chamber and empty the vial completely.
5. Stir the water sample. Immediately rinse the vial with the water sample and fill with **10 ml water sample**.
6. Close the vial tightly with the cap and swirl gently several times.
7. Place the vial in the sample chamber making sure that the  $\Sigma$  marks are aligned.

Zero accepted  
prepare Test  
press TEST

8. Press **TEST** key.

The result is shown in the display in FAU.

## 1.1 Methods

**Note:**

1. This test uses an attenuated radiation method for the reading of FAU (Formazin Attenuation Units). The results can not be used for USEPA reporting purposes, but may be used for routine measurements. The attenuated radiation method is different from the Nephelometric method.
2. The estimated detection limit is 20 FAU.
3. Collect water samples in clean plastic or glass bottles and analyse the water sample as soon as possible. It is possible to store the sample at 4°C for 48 hours. Before measurement warm up the sample to the temperature at collection time. Temperature differences between measurement and sample collection can effect the turbidity of the sample.
4. Colour interferes if light is absorbed at 530 nm. For strong coloured water samples a filtrated portion of the sample can be used for zeroing instead of the deionised water.
5. Air bubbles interfere and can be removed using an ultrasonic bath.

## 1.1 Methods

3 9 0

### Urea with Tablet and Liquid Reagent

0.1 – 2.5 mg/l  $(\text{NH}_2)_2\text{CO}$  / mg/l Urea



Ø 24 mm

prepare Zero  
press ZERO

1. Fill a clean vial (24 mm Ø) with **10 ml of the water sample**, close tightly with the cap.
2. Place the vial in the sample chamber making sure that the  $\Sigma$  marks are aligned.
3. Press **ZERO** key.
4. Remove the vial from the sample chamber.
5. In the presence of free Chlorine (HOCl), add **one UREA PRETREAT tablet** straight from the foil and crush the tablet using a clean stirring rod (Note 10).
6. Close the vial tightly with the cap and swirl several times to mix the contents.
7. Add **2 drops of Urea reagent 1** to the water sample (Note 9).
8. Close the vial tightly with the cap and swirl several times to mix the contents.
9. Add **1 drop of Urea Reagent 2** (Urease) to the same water sample (Note 9).
10. Close the vial tightly with the cap and swirl several times to mix the contents.
11. Press **[↵]** key.  
Wait for a **reaction period of 5 minutes**.  
After the reaction period is finished proceed as follows:
12. Add **one AMMONIA No. 1 tablet** straight from the foil to the prepared water sample and mix to dissolve with a clean stirring rod.

Countdown  
5:00  
start: ↵



## 1.1 Methods

Zero accepted  
prepare Test  
press TEST

Countdown  
10:00

13. Add **one AMMONIA No. 2 tablet** straight from the foil to the same water sample and mix to dissolve with a clean stirring rod.
14. Close the vial tightly with the cap and swirl several times until the tablets are dissolved.
15. Place the vial in the sample chamber making sure that the  $\times$  marks are aligned.
16. Press **TEST** key.  
Wait for a **reaction period of 10 minutes**.

After the reaction period is finished the measurement starts automatically.

The result is shown in the display in mg/l Urea.

### Notes:

1. The sample temperature should be between 20°C and 30°C.
2. Carry out the test at the latest one hour after sample taking.
3. Concentrations above 2 mg/l Urea can produce results inside the measuring range. In this case, the water sample should be diluted with Urea free water and remeasured.
4. The tablets must be added in the correct sequence.
5. The AMMONIA No. 1 tablet will only dissolve completely after the AMMONIA No. 2 tablet has been added.
6. **Do not store reagent 1 (Urease) below 10°C; granulation is possible. Store reagent 2 (Urease) in the refrigerator at a temperature of 4°C to 8°C.**
7. Ammonia and chloramines are also measured during urea measurement.
8. Before analysing seawater samples, a measuring spoon of Ammonia Conditioning Powder must be added to the sample and swirled to dissolve before AMMONIA No. 1 tablet is added.
9. Fill the vial with drops of the same size by holding the bottle vertically and squeeze slowly.
10. One UREA PRETREAT tablet compensates for the interference of free Chlorine up to 2 mg/l (two tablets up to 4 mg/l, three tablets up to 6 mg/l).

Reagent / Accessories	Form of reagent/Quantity	Order-No.
UREA PRETREAT	Tablet / 100	516110BT
UREA Reagent 1	Liquid reagent / 15 ml	459300
UREA Reagent 2	Liquid reagent / 10 ml	459400
<b>Set</b> AMMONIA No. 1 / No. 2	Tablet / per 100 inclusive stirring rod	517611BT
AMMONIA No. 1	Tablet / 100	512580BT
AMMONIA No. 2	Tablet / 100	512590BT

## 1.1 Methods

4 0 0

### Zinc with Tablet

0.02 – 0.9 mg/l Zn



Ø 24 mm

1. Fill a clean vial (24 mm Ø) with **10 ml of the water sample**.
2. Add **one COPPER / ZINC LR tablet** straight from the foil to the water sample, crush the tablet using a clean stirring rod.
3. Close the vial tightly with the cap and swirl several times until the tablet is dissolved.
4. Place the vial in the sample chamber making sure that the **X** marks are aligned.

prepare Zero  
press ZERO

Countdown  
5:00

5. Press **ZERO** key.  
Wait for a **reaction period of 5 minutes**.  
After the reaction period is finished the measurement starts automatically.
6. Remove the vial from the sample chamber.
7. Add **one EDTA tablet** straight from the foil to the prepared vial and crush the tablet using a clean stirring rod.
8. Close the vial tightly with the cap and swirl several times until the tablet is dissolved.
9. Place the vial in the sample chamber making sure that the **X** marks are aligned.

Zero accepted  
press ZERO  
press TEST

10. Press **TEST** key.

The result is shown in the display in mg/l Zinc.

## 1.1 Methods

### Notes:

1. The tablets must be added in the correct sequence.
2. In the case of high levels of residual chlorine, perform the analysis with a dechlorinated water sample. To dechlorinate add one DECHLOR tablet to the water sample (point 1). Crush and mix to dissolve the tablet. Then add the COPPER / ZINC LR tablet (point 2) and continue with the test procedure as described above.
3. When using the copper/zinc LR tablets, the Zincon indicator reacts with both the zinc and the copper. Therefore, the specified measuring range may possibly refer to the total concentration of both ions.
4. Concentrations above 1mg/l may lead to results within the measurement range. In this case, it is recommended to carry out a dilution of sample prior to analysis as a plausibility check.
5. The addition of an EDTA tablet during the second step of the analysis ensures that any copper presence does not interfere with the test.
6. Before analysis, strong alkaline or acidic samples should be adjusted to pH 9 (with 1 mol/l hydrochloric acid, 1 mol/l sodium hydroxide).

Reagent / Accessories	Form of reagent/Quantity	Order-No.
COPPER / ZINC LR	Tablet / 100	512620BT
EDTA	Tablet / 100	512390BT
DECHLOR	Tablet / 100	512350BT

## 1.1 Methods

4

0

5

### Zinc with Liquid reagent and powder

0.1 – 2.5 mg/l Zn



prepare Zero  
press ZERO

1. Fill a clean vial (24 mm Ø) with **10 ml of the water sample**, close tightly with the cap.
2. Place the vial in the sample chamber making sure that the X marks are aligned.
3. Press **ZERO** key.

4. Remove the vial from the sample chamber.

5. Fill the vial with drops of the same size by holding the bottle vertically and squeeze slowly:

**20 drops KS243 (Zinc Reagent 1)**

6. Close the vial tightly with the cap and swirl several times to mix the contents.

7. Add **1 level spoon of reagent KP244 (Zinc Reagent 2)** (note 1).

8. Close the vial tightly with the cap and swirl several times to dissolve the powder.

9. Place the vial in the sample chamber making sure that the X marks are aligned.

Zero accepted  
press ZERO  
press TEST

10. Press **TEST** key.

The result is shown in the display in mg/l Zinc.

## 1.1 Methods

### Notes:

1. For correct dosage the spoon supplied with the reagents must be used.
2. This test is suitable for determining free soluble Zinc. Zinc bound with strong complexing agents will not be measured.
3. Cationics such as quaternary ammonium compounds will cause the colour to change from rose red to purple, depending upon the level of copper present. In this event add drops of KS89 (cationic suppressor) one at a time, mixing between additions until the orange/blue colour is obtained.

Reagent / Accessories	Form of reagent/Quantity	Order-No.
KS243 – Zinc Reagent 1	Liquid reagent / 65 ml	56L024365
KP244 – Zinc Reagent 2	Powder / 20 g	56P024420

## 1.2 Important notes

### 1.2.1 Correct use of reagents

The reagents must be added in the correct sequence.

#### Tablet reagents:

The tablet reagents should be added to the water sample straight from the foil without touching them with the fingers.

#### Liquid reagents:

Add drops of the same size to the water sample by holding the bottle vertically and squeezing slowly.

After use replace the bottle caps securely noting the colour coding.

Note recommendation for storage (e.g. cool and dry).

#### Powder Packs:

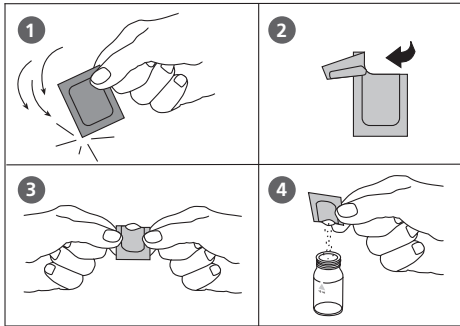

#### VARIO Chlorine DPD / F10

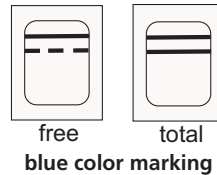

#### Vacu-vials® from CHEMetrics:

Vacu-vials® should be stored in the dark and at room temperature.

For further information see MSDS.

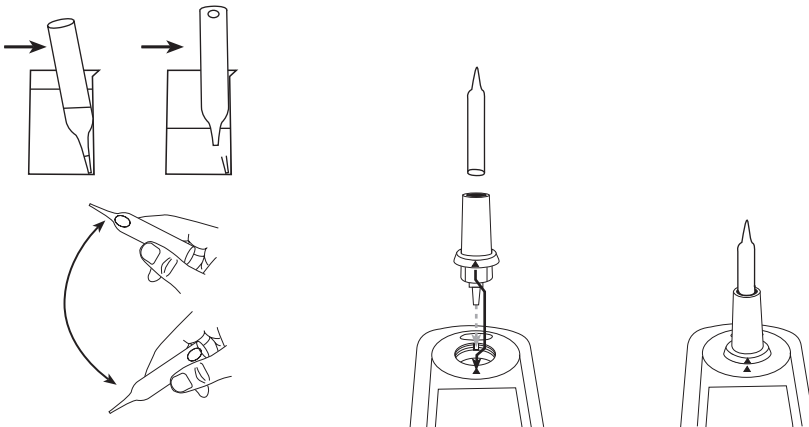

## 1.2.2 Cleaning of vials and accessories for analysis

Vials, caps and stirring rods should be cleaned thoroughly **after each analysis** to prevent interferences.

### Procedure:

Clean vials and accessories after each analysis as soon as possible.

- Clean vials and accessories with laboratory detergent (e.g. Extran® MA 02 (neutral, phosphatic), Extran® MA 03 (alkaline, phosphate-free) from Merck KGaA).
- Rinse thoroughly with tap water.
- On demand (see Notes) perform special cleaning as required, e.g.: rinse with diluted Hydrochloric acid solution.
- Rinse thoroughly with deionised water.

## 1.2.3 Guidelines for photometric measurements

- Vials, caps and stirring rods should be cleaned thoroughly after each analysis to prevent interferences. Even minor reagent residues can cause errors in the test result.
- The outside of the vial must be clean and dry before starting the analysis. Clean the outside of the vials with a towel. Fingerprints or other marks will be removed.
- If there is no defined vial for the blank, the zeroing and the test must be carried out with the same vial as there may be slight differences in optical performance between vials.
- The vials must be positioned in the sample chamber for zeroing and test with the  $\nabla$  mark on the instrument.

### Correct position of the vial (Ø 24 mm):

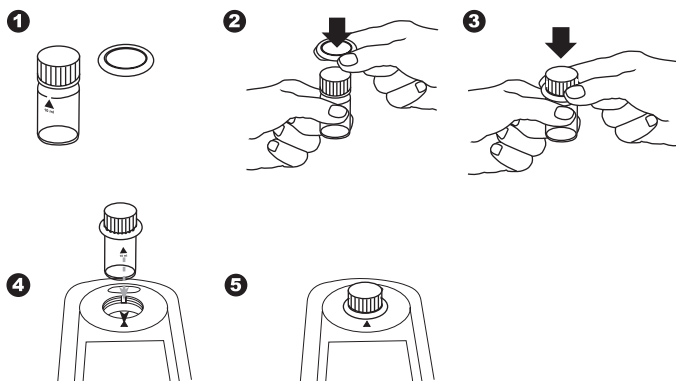

5. Always perform zeroing and test with closed vial cap. Only use cap with sealing ring.
6. Bubbles on the inside wall of the vial lead to incorrect measurements. To prevent this, remove the bubbles by swirling the vial before performing the test.
7. Avoid spillage of water in the sample chamber. If water should leak into the instrument housing, it can destroy electronic components and cause corrosion.
8. Contamination of the lens in the sample chamber can result in errors. Check at regular intervals and – if necessary – clean the light entry surfaces of the sample chamber using a moist cloth or cotton buds.
9. Large temperature differences between the instrument and the environment can lead to errors – e.g. due to the formation of condensation in the area of the lens or on the vial.
10. To avoid errors caused by stray light do not use the instrument in bright sunlight.

### Correct filling of the vial:

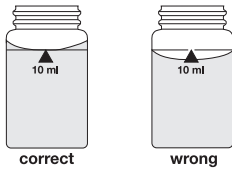

### Insertion of the adapter:

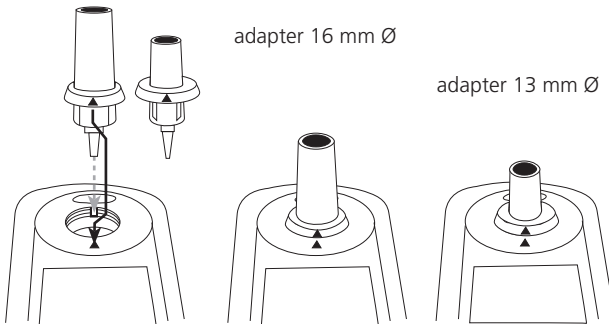



## 1.2.4 Sample dilution techniques

Proceed as follows for accurate dilutions:

Pipette the water sample (see table) into a 100 ml volumetric flask and fill up to 100 ml mark with deionised water. Swirl to mix the contents.

Water sample [ml]	Multiplication factor
1	100
2	50
5	20
10	10
25	4
50	2

Pipette the required volume of the diluted sample into the vial and proceed as described in the test methods.

### Caution:

1. Dilution decreases accuracy.
2. Do not dilute water samples for measurement of pH-values. This will lead to incorrect test results. If "Ovrange" is displayed use another instrument (e.g. pH-meter).

## 1.2.5 Correcting for volume additions

If a larger volume of acid or base is used to pre-adjust the pH-value, a volume correction of the displayed result is necessary.

### Example:

For adjusting the pH-value of a 100 ml water sample 5 ml of acid had to be added. The corresponding displayed result is 10 mg/l.

$$\text{Total volume} = 100 \text{ ml} + 5 \text{ ml} = 105 \text{ ml}$$

$$\text{Correction factor} = 105 \text{ ml} / 100 \text{ ml} = 1.05$$

$$\text{Corrected result} = 10 \text{ mg/l} \times 1.05 = 10.5 \text{ mg/l}$$



# **Part 2**

# **Instrument Manual**

## 2.1 Operation

### 2.1.1 Set up

Before working with the photometer insert the batteries (delivery contents). See chapter 2.1.2 Saving data – Important Notes, 2.1.3 Replacement of batteries.

**Before using the photometer perform the following settings in the Mode-Menu:**

- MODE 10: select language
- MODE 12: set date and time
- MODE 34: perform „Delete data“
- MODE 69: perform “User m. init” to initialise the userpolynomial system

See chapter 2.4 Photometer settings.

### 2.1.2 Saving data – Important Notes

The batteries save data (stored results and photometer setting).

During battery change the data in the MD 600 is saved for 2 minutes. If the change time exceeds 2 minutes all stored data and settings are lost.

Recommendation: for replacement a screwdriver and new batteries must be available.

### 2.1.3 Replacement of batteries

See chapter 2.1.2 "Saving data - important notes" before replacing batteries.

1. Switch the instrument off.
2. If necessary remove vial from the sample chamber.
3. Place the instrument upside down on a clean and even surface.
4. Unscrew the four screws (A) of the battery compartment cover (B).
5. Lift off battery compartment cover at the notch (C).
6. Remove old batteries (D).
7. Place 4 new batteries.

**Ensuring the correct polarity!**

8. Replace the battery compartment cover.  
Check the seal ring (E) of the notch to make sure it is tight-fitting
9. Tighten the screws carefully.

**CAUTION**

Dispose of used batteries in accordance with all federal, state and local regulations.

## 2.1.4 Instrument (explosion drawing):

- (A) screws
- (B) battery compartment cover
- (C) notch
- (D) batteries: 4 batteries (AA/LR6)
- (E) seal ring
- (F) instrument back

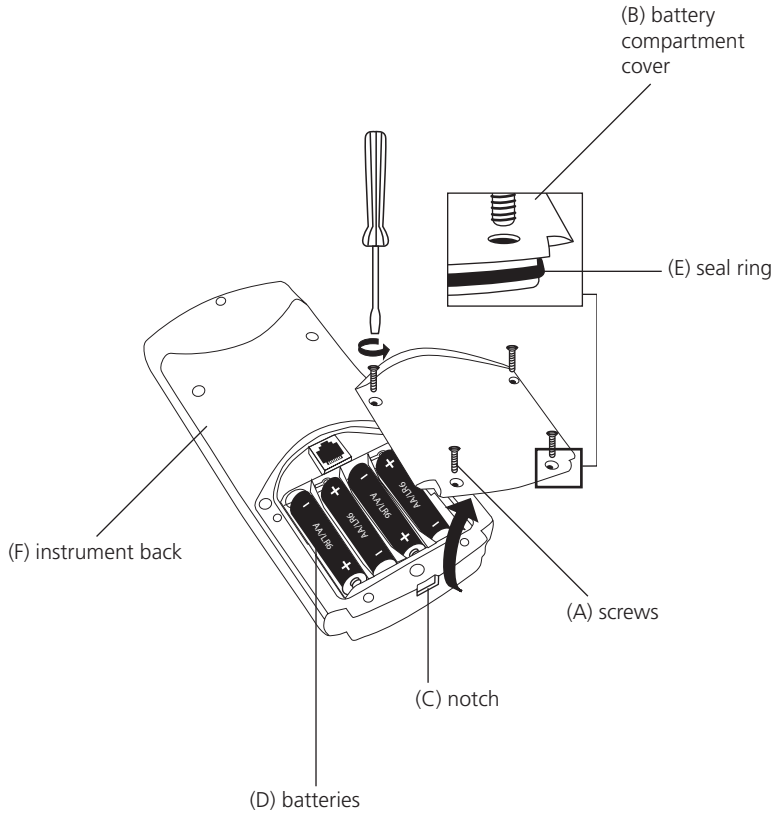

### CAUTION:

To ensure that the instrument is water proof:

- seal ring (E) must be in position
- battery compartment cover (B) must be fixed with the four screws



## 2.2 Overview of function keys

### 2.2.1 Overview



Switching the photometer on or off



Press shift key to achieve figures key 0-9.  
Keep the shift key depressed and press desired figures key.  
e.g.: [Shift] + [1][1]



Returning to selection of methods or previous menu



Function key: description in the text if key available



Function key: description in the text if key available



Function key: description in the text if key available



Confirming



Menu of photometer settings and further functions



Moving the cursor up or down



Storing of displayed test result



Performing Zero



Performing Test



Displaying date and time / user countdown



Decimal point

### 2.2.2 Displaying time and date:



Press [“clock”] key.

**19:30:22 2012-06-15**

The display shows:



After 15 seconds the photometer reverts to the previous display automatically  
or press [↵] key or [ESC].

### 2.2.3 User countdown

With this function the operator is able to define his own countdown.



Press [“clock”] key.

**19.30.20 2012-06-15**

The display shows time and date:



Press [“clock”] key.

**Countdown**  
**mm : ss**  
**99 : 99**

The display shows:

Either press [↵] key to accept the last used user countdown.  
or

press any number key to start entering a new value

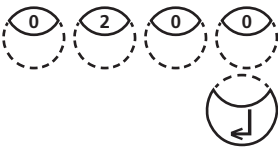

The entry comprises two digits each.

Enter minutes and seconds,  
e.g.: 2 minutes, 0 seconds = [Shift] + [0][2][0][0].  
Confirm with [↵] key.

**Countdown**  
**02:00**  
**start: ↵**

The display shows:

Start countdown with [↵] key.

After countdown has finished the photometer reverts to the previous display automatically.

### 2.2.4 Display backlight



Press the [Shift] + [F1] key to turn the display backlight on or off. The backlight is switched off automatically during the measurement.



## 2.3 Operation mode



Switch the photometer on by pressing the [ON/OFF] key.

**selftest ...**

The photometer performs an electronic self-test.

### 2.3.1 Automatic switch off

The instrument switches off automatically after 20 minutes. This is indicated 30 seconds before by a beeper. Press any key to avoid the instrument switching off.

As long as the instrument is working (for example countdown or printing) the automatic switch off is inactive.

### 2.3.2 Selecting a method

**>> 30 Alkalinity-m  
35 Alkalinity-p  
40 Aluminium**

The display shows a selection:

There are two possibilities to select the required method:



a) enter method-number directly  
e.g.: [Shift] + [8] [0] to select Bromine



b) press arrow key [▼] or [▲] to select the required method from the displayed list.



Confirm with [↵] key.

#### 2.3.2.1 Method Information (F1)

Use [F1] key to switch between the compact and the detailed list for method selection.

**100 Chlorine  
0.02-6 mg/l Cl<sub>2</sub>  
Tablet  
24 mm  
DPD No 1  
DPD No 3**

**Example:**

Line 1: Method number, Method name  
Line 2: Range  
Line 3: Kind of reagent  
Line 4: Vial  
Line 5-7: Used reagent  
tube = reagent vial contained in tube test

### 2.3.2.2 Chemical Species Information

Pressing the [F2] key the display shows a list with available chemical species and corresponding ranges. Changing chemical species see chapter 2.3.7 page 308.

**320 Phosphate LR T**  
**0.05-4 mg/l PO<sub>4</sub>**  
**0.02-1.3 mg/l P**  
**0.04-3 mg/l P<sub>2</sub>O<sub>5</sub>**

Line 1: Method number, Method name  
 Line 2: Range with chemical species 1  
 Line 3: Range with chemical species 2  
 Line 4: Range with chemical species 3

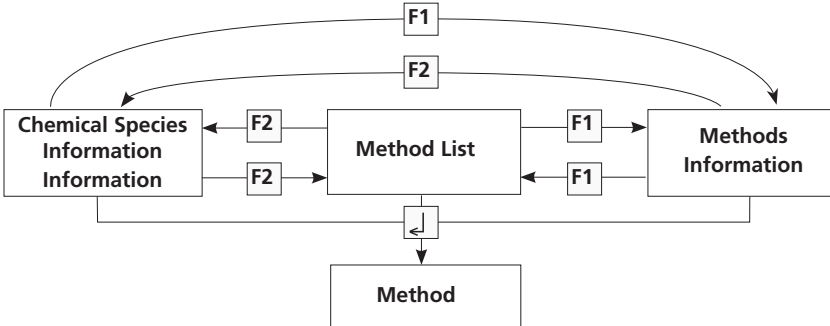

### 2.3.3 Differentiation

**Chlorine**  
 >> **diff**  
       **free**  
       **total**

Differentiation is possible in some methods (e.g. Chlorine). The photometer then requires the type of determination.



Press arrow key [▼] or [▲] to select the required determination.



Confirm with [↵] key.

### 2.3.4 Performing Zero

**prepare Zero**  
**press ZERO**

The display shows:



Prepare a clean vial as described in "Method" and place the vial in the sample chamber making sure that the X marks are aligned.

Press [ZERO] key.

**Zero accepted**  
**prepare Test**  
**press TEST**

The display shows:

## 2.3.5 Performing Tests

When zero calibration is complete, remove the vial from the sample chamber and perform the tests as described under "Method".

When the results have been displayed:

- with some methods you can change between different chemical species
- you can store and/or print out the results
- perform further analysis with the same zero
- select a new method

## 2.3.6 Ensuring reaction periods (countdown)

To ensure compliance with reaction periods a time delay is incorporated: the countdown. There are two kinds of countdowns:

**Countdown**  
**2:00**  
**start:** ↵



- Press [↵] key.  
Prepare water sample, start countdown with [↵] key and proceed as described in the mode description.  
The vial must not be placed in the sample chamber.



**Countdown**  
**1:59**

- Press [TEST] key.  
Prepare the water sample as described in the method description and place the vial in the sample chamber. The display shows the countdown by pressing the [TEST] key and the countdown is started automatically. After the reaction period is finished the measurement starts automatically.

### Notes:

1. It is possible to finish the working countdown by pressing the [↵] key. Reading starts immediately. In this case the operator is responsible for ensuring the necessary reaction period.

### **Non-compliance with reaction periods leads to incorrect test results.**

2. The time remaining is displayed continuously.  
The beeper indicates the last 10 seconds.

### 2.3.7 Changing chemical species

For some methods there is a possibility to change the chemical species of the test result. If the test result is displayed press arrow key [▲] or [▼].

**Example:**

320 Phosphate LR T	-----[▼]----->	320 Phosphate LR T	<----- [▼] -----	320 Phosphate LR T
0.05-4 mg/l PO <sub>4</sub>		0.02-1.3 mg/l P		0.04-3 mg/l P <sub>2</sub> O <sub>5</sub>
	<----- [▲] -----		----- [▲] ----->	
1.00 mg/l PO <sub>4</sub>		0.33 mg/l P		0.75 mg/l P <sub>2</sub> O <sub>5</sub>

If the species of a test result is changed the displayed range is adjusted automatically. For an already stored result it is not possible to change the chemical species. The last displayed chemical species is kept by the instrument and will be displayed if this method is used the next time. If there is the possibility to change the chemical species for a method it is described in the manual. The arrows indicate the possible chemical species and are printed below the notes of the method:

- ▲ PO<sub>4</sub>
- P
- ▼ P<sub>2</sub>O<sub>5</sub>

### 2.3.8 Storing results



Press [STORE] key while the test result is displayed.



The display shows:



- We advise you to enter a numeric code (up to 6 places). (A Code No. can contain references to the operator or the sampling location.)



After entering confirm with [↵] key.



- If a code number is not necessary confirm by pressing [↵] directly. (The assignment for the Code No. is then 0 automatically.)

The entire data set is stored with date, time, Code No., method and test result.



The display shows:

The test result is then shown again.

**Storage: 900  
free records left**

**Storage: only 29  
free records left**

**Note:**

The display shows the number of free data sets.

If there are less than 30 data sets free the display shows:

Clear the memory as soon as possible (see “Deleting stored results”). If memory capacity is used up it is impossible to save additional test results.

### 2.3.9 Printing results (Infra-Red Interface Module) (optional)

If the IRIM (see chapter 2.5) is switched on and the printer is connected, it is possible to print out the test results (without saving it beforehand).



Press [F3] key.

The entire data set is printed with date, time, Code No., method and test result. Printing example:

```
100 Chlorine T
0.02-6 mg/l Cl2
Profi-Mode: no
2009-07-01 14:53:09
Test No.: 1
Code-Nr.: 007
4.80 mg/l Cl2
```

The test No. is an internal number that is set automatically if a test result is stored. It appears only on the print out.

### 2.3.10 Perform additional measurements



**Zero accepted  
prepare Test  
press TEST**

To perform additional tests using the same method:

- Press [TEST] key

The display shows:



Confirm with [TEST] key

or



- Press [ZERO] key to perform a new zero calibration.

**prepare Zero  
press ZERO**

The display shows:

### 2.3.11 Selecting a new method



Press [ESC] key to return to method selection.



Or enter the required method number directly, e.g. [Shift] + [1][6][0] for CyA-TEST (Cyanuric acid).



Confirm with [↵] key.

### 2.3.12 Measure absorbance

Range: -2600 mAbs to +2600 mAbs

Method-No.	Title
900	mAbs 430 nm
910	mAbs 530 nm
920	mAbs 560 nm
930	mAbs 580 nm
940	mAbs 610 nm
950	mAbs 660 nm

Select the desired wavelength from the method list or by entering the corresponding method number directly.

**900 mAbs 430 nm**  
**-2600 mAbs - + 2600 mAbs**  
**prepare Zero**  
**press ZERO**

The display shows e.g.:

Always carry out zeroing using a filled (e.g. deionised water) vial.

**Zero accepted**  
**prepare Test**  
**press TEST**

The display shows:

Carry out measurement of the sample.

**500 mAbs**

The display shows e.g.:

TIP: To ensure complete reaction times the user countdown may be helpful (chapter 2.2.3, page 304).

## 2.4 Photometer settings: Table of Mode Functions

<b>MODE-Function</b>	<b>No.</b>	<b>Description</b>	<b>Page</b>
Calibration	40	Special method calibration	326
Clear calibration	46	Deleting user calibration	333
Clock	12	Setting date and time	313
Countdown	13	Switching the countdown on/off to ensure reaction times	314
Delete data	34	Deleting all stored results	325
Key beep	11	Switching the acoustic signal on/off to indicate key-pressing	313
Langelier	70	Calculation of Langelier saturation Index (Water Balance)	346
Language	10	Selecting language	312
LCD contrast	80	Setting the display contrast	348
LCD brightness	81	Setting the display brightness	348
Method list	60	User method list, adaption	336
M list all on	61	User method list, switching on all methods	337
M list all off	62	User method list, switching off all methods	337
OTZ	55	One Time Zero (OTZ)	335
Print	20	Printing all stored results	316
Print, code no.	22	Print only results of a selected Code No. range	318
Print, date	21	Print only results of a selected time period	317
Print, method	23	Print only results of one selected method	319
Printing parameters	29	Setting of printing options	320
Profi-Mode	50	Switching the detailed operator instructions on/off	334
Signal beep	14	Switching the acoustic signal on/off to indicate end of reading	315
Storage	30	Displaying all stored results	321
Stor., code	32	Displaying only results of a selected Code No. range	323
Stor., date	31	Displaying only results of a selected time period	322
Stor., method	33	Displaying only results of one selected method	324
System info	91	Information about the instrument e.g. current software version	349
Temperature	71	Selection of °C or °F for Langelier Mode 70	347

MODE-Function	No.	Description	Page
User calibration	45	Storage of user calibration	332
User concentration	64	Entering the data necessary to run a user concentration method	338
User polynoms	65	Entering the data necessary to run a user polynomial	340
User methods clear	66	Delete all data of a user polynomial or of a concentration method	343
User methods print	67	Print out all data stored with mode 64 (concentration) or mode 65 (polynomial)	344
User methods init	69	Initialise the user method system (polynomial and concentration)	345

**The selected settings are kept by the photometer even when switched off. To change photometer settings a new setting is required.**

## 2.4.1 blank because of technical requirements

## 2.4.2 Instrument basic settings 1

### Selecting a language



Press [MODE], [Shift] + [1][0] keys.



Confirm with [←] key.

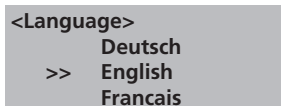

The display shows:

Press arrow key [▼] or [▲] to select the required language from the displayed list.



Confirm with [←] key.



## Key beep

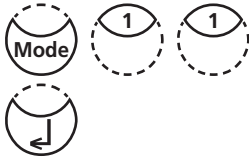

Press [MODE], [Shift] + [1][1] keys.

Confirm with [↵] key.

<Key-Beep>  
ON: 1 OFF: 0

The display shows:



- Press [Shift] + [0] keys to switch the key beep

- Press [Shift] + [1] keys to switch the key beep on.

Confirm with [↵] key.

### Note:

In the case of methods with reaction periods, an acoustic signal still sounds during the last 10 seconds of the countdown even if the key beep is switched off.

## Setting date and time

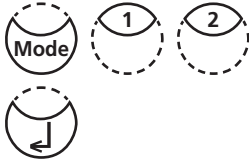

Press [MODE], [Shift] + [1][2] keys.

Confirm with [↵] key.

<clock>  
yy-mm-dd            hh:mm  
--:--                -::

The display shows:

The entry comprises two digits each.

yy-mm-dd            hh:mm  
09-05-14            -::

Enter year, month and day,

e.g.: 14. May 2009 = [Shift] + [0][9][0][5][1][4]

yy-mm-dd            hh:mm  
09-05-14            15:07

Enter hours and minutes

e.g.: 3.07 p.m. = [Shift] + [1][5][0][7]



Confirm with [↵] key.

### Note:

While confirming date and time with [↵] key the seconds are adjusted to zero automatically.

## Countdown (Ensuring reaction periods)

Some methods require a reaction period. This reaction period is incorporated in the method as standard with the countdown function.

It is possible to switch the countdown off for all methods:



Press [MODE], [Shift] + [1][3] keys.



Confirm with [↵] key.

<Countdown>  
ON: 1 OFF: 0

The display shows:



- Press [Shift] + [0] keys to switch the countdown off.



- Press [Shift] + [1] keys to switch the countdown on.



Confirm with [↵] key.

### Notes:

1. It is possible to interrupt the working countdown by pressing the [↵] key (application e.g. serial analysis).  
The “user countdown” is also available if the countdown is switched off.
2. If the countdown function is switched off, the operator is responsible for ensuring the necessary reaction period.

**Non-compliance with reaction periods leads to incorrect test results.**

## Signal beep

Performing a zero or a measurement takes 8 seconds. The photometer indicates the end of zeroing or measuring by a short beep.



Press [MODE], [Shift] + [1][4] keys.



Confirm with [↶] key.

<Signal-Beep>  
ON: 1 OFF: 0

The display shows:



- Press [Shift] + [0] keys to switch the signal beep off.



- Press [Shift] + [1] keys to switch the signal beep on.



Confirm with [↶] key.

### Note:

In the case of methods with reaction periods, an acoustic signal still sounds during the last 10 seconds of the countdown even if the key beep is switched off.

## 2.4.3 Printing of stored results

### Printing all results



Press [MODE], [Shift] + [2][0] keys.



Confirm with [↵] key.

```
<Print>
Print all Data
  Start:  ↵
  cancel: ESC
```

The display shows:

Press [↵] key for printing out all stored test results.



```
Test No.:
```

The display shows e.g.:

After printing the photometer goes back to <Mode-Menu> automatically.

#### Note:

It is possible to cancel the entry by [ESC].  
All stored data are printed out.  
See chapter 2.5.1 Data Printing.

## Printing results of a selected time period



Press [MODE], [Shift] + [2][1] keys.



Confirm with [↵] key.

**<Print>**  
**sorted: date**  
**from yy-mm-dd**  
\_ \_ - \_

The display shows:

Enter year, month and day for the first day of the required period, e.g.: 14 May 2009 = [Shift] + [0][9][0][5][1][4]



Confirm with [↵] key.

**to yy-mm-dd**  
\_ \_ - \_

The display shows:

Enter year, month and day for the last day of the required period, e.g.: 19 May 2009 = [Shift] + [0][9][0][5][1][9]



Confirm with [↵] key.

**from 2009-05-14**  
**to 2009-05-19**  
**Start:** ↵  
**cancel: ESC**

The display shows:

Press [↵] key and all stored results in the selected date range are printed.

After printing the photometer goes back to mode menu automatically.

### Note:

It is possible to cancel the entry by [ESC].

If you want to print only results of one day enter the same date twice to determine the period.

## Printing results of a selected Code No. range



Press [MODE], [Shift] + [2][2] keys.



Confirm with [↵] key.

<Print>  
sorted: Code-No.  
from -----

The display shows:

Enter numeric code number (up to 6 places) for the first required Code No., e.g.: [Shift] + [1].



Confirm with [↵] key.

to -----

The display shows:

Enter numeric code number (up to 6 places) for the last required Code No., e.g.: [Shift] + [1][0].



Confirm with [↵] key.

from 000001  
to 000010  
Start: ↵  
cancel: ESC

The display shows:

Press [↵] key and all stored results in the selected code number range are printed.

After printing the photometer goes back to mode menu automatically.

### Note:

It is possible to cancel the entry by [ESC].

If you want to print only results of one code number enter the same code number twice.

If you want to print all results without code no. (code no. is 0) enter Zero [0] twice.

## Printing results of one selected method



Press [MODE], [Shift] + [2]/[3] keys.



Confirm with [↵] key.

```
<Print>  
>>20 Acid demand  
30 Alkalinity-tot  
40 Aluminium T
```

The display shows:

Select the required method from the displayed list or enter the method-number directly.



Confirm with [↵] key.

In case of differentiated methods select the required kind of determination and confirm with [↵] key.

```
<Print>  
method  
30 Alkalinity-tot  
Start: ↵  
cancel: ESC
```

The display shows:

Press [↵] key and all stored results of the selected method are printed.

After printing the photometer goes back to mode menu automatically.

### Note:

It is possible to cancel the entry by [ESC].

## Printing Parameter

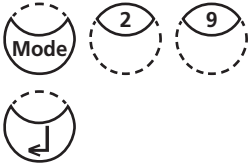

Press [MODE], [Shift] + [2][9] keys.

Confirm with [↵] key.

```
<printing parameter>
2: Baud rate
```

```
cancel:          ESC
```

The display shows:

Press [Shift] + [2] keys to select "Baud rate".

```
<Baud rate>
is: 19200
select:  [▲] [▼]
save:    ↵
cancel:  ESC
```

The display shows:

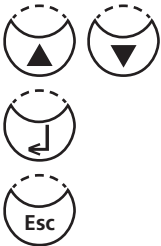

Press arrow key [▼] or [▲] to select the required baud rate.  
(1200, 2400, 4800, 9600, 14400, 19200)

Confirm with [↵] key.

End with [ESC] key.

Back to Mode Menu with [ESC] key.

Back to method selection with [ESC] key.



## 2.4.4 Recall / delete stored results

### Recall all stored results

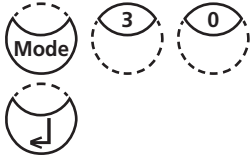

Press [MODE], [Shift] + [3][0] keys.

Confirm with [↵] key.

```
<Storage>
display all data
Start:  ↵  cancel:  ESC
print:  F3
print all: F2
```

The display shows:

The stored data sets are displayed in chronological order, starting with the latest stored test result. Press [↵] key and all stored results are displayed.

- Press [F3] key to print the displayed result.
- Press [F2] key to print all results.
- End with [ESC].
- Press arrow key [▼] to display the following test result.
- Press arrow key [▲] to display the previous test result.



```
no data
```

If there are no test results in memory the display shows:

## Recall results of a selected time period



Press [MODE], [Shift] + [3][1] keys.



Confirm with [↵] key.

<Storage>  
sorted: date  
from yy-mm-dd  
\_ \_ \_ \_

The display shows:

Enter year, month and day for the first day of the required period, e.g.: 14 May 2009 = [Shift] + [0][9][0][5][1][4]



Confirm with [↵] key.

to yy-mm-dd  
\_ \_ \_ \_

The display shows:

Enter year, month and day for the last day of the required period, e.g.: 19 May 2009 = [Shift] + [0][9][0][5][1][9]



Confirm with [↵] key.

from 2009-05-14  
to 2009-05-19  
Start: ↵ cancel: ESC  
print: F3  
print all: F2

The display shows:

- Press [↵] key and all stored results in the selected date range are displayed.
- Press [F3] key to print the displayed result.
- Press [F2] key to print all selected results.
- End with [ESC].

### Note:

It is possible to cancel the entry by [ESC].

If you want to recall only results of one day enter the same date twice to determine the time period.

## Recall results of a selected Code No. range



Press [MODE], [Shift] + [3][2] keys.



Confirm with [↵] key.

<Storage>  
sorted: Code-No.  
from \_\_\_\_\_

The display shows:

Enter numeric code number (up to 6 places) for the first required Code No., e.g.: [Shift] + [1].



Confirm with [↵] key.

to \_\_\_\_\_

The display shows:

Enter numeric code number (up to 6 places) for the last required Code No., e.g.: [Shift] + [1][0].



Confirm with [↵] key.

from 000001  
to 000010  
Start: ↵ cancel: ESC  
print: F3  
print all: F2

The display shows:

- Press [↵] key and all stored results in the selected Code No. range are displayed.
- Press [F3] key to print the displayed result.
- Press [F2] key to print all selected results.
- End with [ESC].

### Note:

It is possible to cancel the entry by [ESC].

If you want to recall only results of one code number enter the same code number twice.

If you want to recall all results without code no. (code no. is 0) enter Zero [0] twice.

## Recall results of one selected method



Press [MODE], [Shift] + [3][3] keys.



Confirm with [↵] key.

```
<Storage>
>>20 Acid demand
  30 Alkalinity-tot
  40 Aluminium T
```

The display shows:

Select the required method from the displayed list or enter the method number directly.



Confirm with [↵] key.

In case of differentiated methods select the required kind of determination and confirm with [↵] key.

```
<Storage>
method
30 Alkalinity-tot
Start: ↵ cancel: ESC
print: F3
print all: F2
```

The display shows:

- Press [↵] key and all stored results of the selected method are displayed.
- Press [F3] key to print the displayed result.
- Press [F2] key to print all selected results.
- End with [ESC].

## Delete stored results

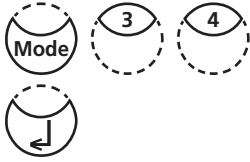

Press [MODE], [Shift] + [3][4] keys.

Confirm with [↵] key.

```
<Delete data>
Delete all data?
YES : 1 NO : 0
```

The display shows:



- Press [Shift] + [0] keys to retain the data sets in memory.
- After pressing keys [Shift] + [1] the following acknowledgment is displayed:

```
<Delete data>
Delete data ↵
Do not delete: ESC
```

Press [↵] key to delete.

**ATTENTION:**  
**All stored test results are deleted**

or cancel without deleting data by pressing [ESC] key.

### Note:

All stored test results are deleted.

## 2.4.5 Calibration

### Calcium Hardness Method 191 – Calibration of a method blank



Press [MODE], [Shift] + [4] [0] keys.



Confirm with [↵] key.

<Calibration>  
1: M 191 Ca-hardness 2  
2: M 191 reset 0 cali.  
3: M 170 Fluoride L

The display shows:



Press [Shift] + [1] keys.

<Calibration>  
M191 Ca-hardness 2T  
prepare Zero  
press ZERO

The display shows:



1. Fill a clean vial (24 mm Ø) with exactly **10 ml of deionised water**, close tightly with the cap.
2. Place the vial in the sample chamber making sure that the X marks are aligned.
3. Press **ZERO** key.
4. Remove the vial from the sample chamber.
5. Pipette 100 ml of water free of calcium to an appropriate beaker (note 2, 3).
6. Add **10 CALCIO H No. 1 tablets** straight from the foil to the 100 ml of water, crush the tablets using a clean stirring rod and dissolve the tablets completely.
7. Add **10 CALCIO H No. 2 tablets** straight from the foil to the same water, crush the tablets using a clean stirring rod and dissolve the tablets completely.
8. Press [↵] key.

Wait for a **reaction period of 2 minutes**.



Zero accepted  
countdown  
2:00  
Start: ↵

After the reaction period is finished proceed as follows:

9. Rinse the vial (24 mm Ø) with the coloured sample from the beaker and fill with 10 ml of the sample.

**prepare Test**  
**press TEST**

10. Press **TEST** key.

**stored**

The batch related method blank is saved.



Press [↵] key,  
to go back to mode menu.

### Notes:

1. If a new batch of CALCIO tablets is used a calibration of the method blank has to be performed to optimise the results.
2. Deionised or tap water
3. If no water free of Calcium is available these ions can be masked by using EDTA.  
Preparation: Add 50 mg (a spatula-tipful) EDTA to 100 ml water and dissolve.
4. To achieve the most accurate method blank it is important to adhere exactly to the sample volume of 100 ml.

## Calcium Hardness Method 191 – Reset method blank to factory calibration



Press [MODE], [Shift] + [4] [0] keys.



Confirm with [↵] key.

**<Calibration>**  
**1: M 191 Ca-hardness 2**  
**2: M 191 reset 0 cali.**  
**3: M 170 Fluoride L**

The display shows:



Press [Shift] + [2] keys.

**<Calibration>**  
**M191 Ca-hardness 2T**  
**Reset ?**  
**YES: Shift + 1**  
**NO: Shift + 0**

The display shows:



Press [Shift] + [0] keys to keep the method blank.



Press [Shift] + [1] keys to erase the method blank and set the value back to factory calibration.

The instrument goes back to mode menu automatically.

### Fluoride Method 170



Press [MODE], [Shift] + [4] [0] keys.



Confirm with [↵] key.

<Calibration>  
1: M 191 Ca-hardness 2  
2: M 191 reset 0 cali.  
3: M 170 Fluoride L

The display shows:



Press [Shift] + [3] keys.

<Calibration>  
M170 Fluoride L  
ZERO: deionised water  
press ZERO

The display shows:

1. Fill a clean vial (24 mm Ø) with exactly **10 ml of deionised water**, close tightly with the cap.
2. Place the vial in the sample chamber making sure that the marks  are aligned.
3. Press **ZERO** key.
4. Remove the vial from the sample chamber.
5. Add **exactly 2 ml SPADNS reagent solution** to the water sample. **Caution: Vial is filled up to the top!**
6. Close the vial tightly with the cap and swirl gently several times to mix the contents.



**Zero accepted**  
**T1: 0 mg/l F**  
**press TEST**

- Place the vial in the sample chamber making sure that the  $\Sigma$  marks are aligned.
- Press **TEST** key.
- Remove the vial from the sample chamber, empty the vial, rinse vial and cap several times and then fill the vial with exactly **10 ml Fluoride standard** (Concentration 1 mg/l F).
- Add **exactly 2 ml SPADNS reagent solution** to the Fluoride standard.  
**Caution: Vial is filled up to the top!**
- Place the vial in the sample chamber making sure that the  $\Sigma$  marks are aligned.

**T1 accepted**  
**T2: 1 mg/l F**  
**press TEST**

- Press **TEST** key.

**Calibration accepted**

The display shows:



Confirm with **[↵]** key.



Back to method selection with **ESC** key.



Select Fluoride method with keys **[Shift] + [1][7][0]** and **[↵]**.



**Error, absorbance**  
**T2>T1**

If an error message appears please repeat adjustment.

### Notes:

- The same batch of SPADNS reagent solution must be used for adjustment and test.  
The adjustment process needs to be performed for each new batch of SPADNS reagent solution (see Standard methods 20th, 1998, APHA, AWWA, WEF 4500 F D., S. 4-82).
- As the test result is highly dependent on exact sample and reagent volumes, the sample and reagent volumes should always be metered by using a 10 ml resp. 2 ml volumetric pipette (class A).

## User Calibration

If a test method is user calibrated the method name is displayed inverse.

### Procedure:

- Prepare a standard of known concentration and use this standard instead of the sample according to the test procedure.
- It is recommend to use well known standards which are formulated according to DIN EN, ASTM or other international norms or to use certified standards which are commercially available.
- After measuring this standard solution it is possible to change the displayed results to the required value.
- If a method uses a mathematic equation for the calculation of the result, it is only possible to calibrate the basic tests since all the other tests use the same polynomial.
- The same applies for some test procedures which use a polynomial from another test procedure.

### Return to factory calibration:

If the user calibration is deleted the factory calibration is automatically activated.

### Remarks:

The method "Fluoride" cannot be calibrated with mode 45 since the test requires a calibration related to the batch of the liquid reagent (SPADNS) (mode 40, chapter "Fluoride Method 170").

### Table

No.	Method	Recommended range for user calibration
20	Acid demand	1–3 mmol/l
35	Alkalinity-p	100–300 mg/l CaCO <sub>3</sub>
30	Alkalinity-total	50–150 mg/l CaCO <sub>3</sub>
31	Alkalinity-total HR T	50–300 mg/l CaCO <sub>3</sub>
40	Aluminium T	0.1–0.2 mg/l Al
50	Aluminium PP	0.1–0.2 mg/l Al
60	Ammonia T	0.3–0.5 mg/l N
62	Ammonia PP	0.3–0.5 mg/l N
65	Ammonia LR TT	1 mg/l N
66	Ammonia HR TT	20 mg/l N
85	Boron	1 mg/l B
80	Bromine T	Calibration with basic test 100 Chlorine free
81	Bromine PP	Calibration with basic test 110 Chlorine free
90	Chloride	10–20 mg/l Cl <sup>-</sup>
92	Chloride L	10–15 mg/l Cl <sup>-</sup>
100	Chlorine T	0.5–1.5 mg/l Cl
103	Chlorine HR T	0.5–6 mg/l Cl
101	Chlorine L	Calibration with basic test 100 Chlorine free
110	Chlorine PP	0.5–1 mg/l Cl <sub>2</sub>
113	Chlorine MR PP	0.5–1 mg/l Cl <sub>2</sub>
111	Chlorine HR PP	4–5 mg/l Cl <sub>2</sub>
105	Chlorine (KI) HR	70–150 mg/l Cl
120	Chlorine dioxide T	Calibration with basic test 100 Chlorine free
122	Chlorine dioxide PP	Calibration with basic test 110 Chlorine free
125	Chromium	1 mg/l Cr
130	COD LR	100 mg/l O <sub>2</sub>

<b>No.</b>	<b>Method</b>	<b>Recommended range for user calibration</b>
131	COD MR	500 mg/l O <sub>2</sub>
132	COD HR	5 g/l O <sub>2</sub> = 5000 mg/l O <sub>2</sub>
204	Colour	operating range
150	Copper T	0.5–1.5 mg/l Cu
151	Copper L	2–3 mg/l Cu
153	Copper PP	0.5–1.5 mg/l Cu
157	Cyanide	0.1–0.3 mg/l CN
160	CyA-TEST	30–60 mg/l CyA
165	DEHA T	200–400 µg/l DEHA
167	DEHA PP	200 µg/l DEHA
170	Fluoride	Calibration with 0 and 1 mg/l F through Mode 40
210	H <sub>2</sub> O <sub>2</sub> T	Calibration with basic test 100 Chlorine free
213	H <sub>2</sub> O <sub>2</sub> LR L	20-30 mg/l H <sub>2</sub> O <sub>2</sub>
214	H <sub>2</sub> O <sub>2</sub> HR L	200-300 mg/l H <sub>2</sub> O <sub>2</sub>
190	Hardness, Calcium	100–200 mg/l CaCO <sub>3</sub>
191	Hardness, Calcium	100–200 mg/l CaCO <sub>3</sub>
200	Hardness, total T	15–25 mg/l CaCO <sub>3</sub>
201	Hardness, total HR T	Calibration with basic test 200 Hardness, total
205	Hydrazine P	0.2–0.4 mg/l N <sub>2</sub> H <sub>4</sub>
206	Hydrazine L	0.2–0.4 mg/l N <sub>2</sub> H <sub>4</sub>
207	Hydrazine C	0.2–0.4 mg/l N <sub>2</sub> H <sub>4</sub>
215	Iodine	Calibration with basic test 100 Chlorine free
220	Iron T	0.3–0.7 mg/l Fe
222	Iron PP	0.1–2 mg/l Fe
223	Iron (TPTZ) PP	0.3–0.7 mg/l Fe
224	Iron (Fe in Mo) PP	0.5–1.5 mg/l Fe
225	Iron LR L	0.5–1.5 mg/l Fe
226	Iron LR 2 L	1–15 mg/l Fe
227	Iron HR L	6–8 mg/l Fe
240	Manganese T	1–2 mg/l Mn
242	Manganese PP	0.1–0.4 mg/l Mn
243	Manganese HR PP	4–6 mg/l Mn
245	Manganese L	2–3 mg/l Mn
250	Molybdate T	5–15 mg/l Mo
251	Molybdate LR PP	1.5–2.5 mg/l Mo
252	Molybdate HR PP	10–30 mg/l Mo
254	Molybdate HR L	50–70 mg/l Mo
257	Nickel T	6–8 mg/l Ni
260	Nitrate LR	0.5–0.7 mg/l N
265	Nitrate TT	10 mg/l N
270	Nitrite T	0.2–0.3 mg/l N
272	Nitrite LR PP	0.1–0.2 mg/l N
280	Nitrogen, total LR	10 mg/l N
281	Nitrogen, total HR	50–100 mg/l N
300	Ozone (DPD)	Calibration with basic test 100 Chlorine free
290	Oxygen, active	Calibration with basic test 100 Chlorine free
292	Oxygen, dissolved	possible against meter for dissolved oxygen
329	pH-Value LR	6.0–6.6
330	pH-Value T	7.6–8.0
331	pH-Value L	7.6–8.0
332	pH-Value HR	8.6–9.0

No.	Method	Recommended range for user calibration
70	PHMB	15–30 mg/l
320	Phosphate LR T	1–3 mg/l PO <sub>4</sub>
321	Phosphate HR T	30–50 mg/l PO <sub>4</sub>
323	Phosphate, ortho PP	0.1–2 mg/l PO <sub>4</sub>
324	Phosphate, ortho TT	3 mg/l PO <sub>4</sub>
327	Phosphate 1, ortho C	20–30 mg/l PO <sub>4</sub>
328	Phosphate 2, ortho C	1–3 mg/l PO <sub>4</sub>
325	Phosphate, total TT	0.3–6 mg/l P
326	Phosphate, hydr. TT	0.3–0.6 mg/L P
334	Phosphate LR L	5–7 mg/L PO <sub>4</sub>
335	Phosphate HR L	30–50 mg/L PO <sub>4</sub>
316	Phosphonate	1–2 mg/l PO <sub>4</sub>
338	Polyacrylate L	15–20 mg/l Polyacrylic Acid 2'100 sodium salt
340	Potassium	3 mg/l K
350	Silica	0.5–1.5 mg/l SiO <sub>2</sub>
351	Silica LR PP	1 mg/l SiO <sub>2</sub>
352	Silica HR PP	50 mg/l SiO <sub>2</sub>
353	Silica L	4–6 mg/l SiO <sub>2</sub>
212	Sodium hypochlorite	8 %
360	Sulfate PP	50 mg/l SO <sub>4</sub>
355	Sulfate T	50 mg/l SO <sub>4</sub>
365	Sulfide	0.2–0.4 mg/l S
370	Sulfite	3–4 mg/l SO <sub>3</sub>
376	Surfactants, anionic	0.5–1.5 mg/l SDSA
377	Surfactants, nonionic	1.0–5.0 Triton® X-100
378	Surfactants, cationic	0.3–1.0 CTAB
384	Suspended Solids	operating range
380	TOC LR	50 mg/l TOC
381	TOC HR	500 mg/l TOC
388	Tolyltriazole PP	6 mg/ Benzotriazole
386	Turbidity	operating range
390	Urea	1–2 mg/l CH <sub>4</sub> N <sub>2</sub> O
400	Zinc	0.2–0.4 mg/L Zn
405	Zinc	1–1.5 mg/L Zn

## Store user calibration

**100 Chlorine T**  
**0.02-6 mg/l Cl<sub>2</sub>**  
**0.90 mg/l free Cl<sub>2</sub>**

Perform the required method as described in the manual using a standard of known concentration instead of the water sample.

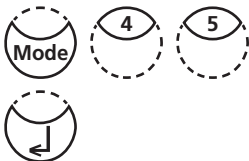

If the test result is displayed press [MODE], [Shift] + [4] [5] keys and confirm with [↵] key.

<user calibration>  
100 Chlorine T  
0.02-6 mg/l Cl2  
0.90 mg/l free Cl2  
up: ↑, down: ↓  
save: ↵

The display shows:

Pressing the arrow key [▲] once increases the displayed result.

Pressing the arrow key [▼] once decreases the displayed result.

Press keys till the displayed result corresponds to the value of the standard.

Confirm with [↵] key to store the new calibration factor.  
Cancel user calibration by pressing [ESC] key.



Jus Factor  
saved

The display shows:

100 Chlorine T  
0.02-6 mg/l Cl2  
1.00 mg/l free Cl2

Now the method name is displayed inverse and the test result is calculated with the new calibration factor.

## Delete user calibration

This chapter only applies for methods which can be user calibrated.

100 Chlorine T  
0.02-6 mg/l Cl2

Select the required method.

prepare ZERO  
press ZERO

Instead of zeroing the instrument press [MODE], [Shift] + [4][6] keys and confirm with [↵] key.

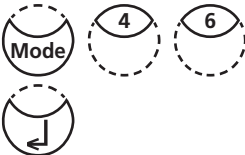

<user calibration>  
100 Chlorine T  
0.02-6 mg/l Cl2  
clear user  
calibration?  
YES: 1, NO: 0

The display shows:



Press [Shift] + [1] keys to delete user calibration.

Press [Shift] + [0] keys to keep the valid user calibration.

The instrument goes back to Zero-query automatically.

## 2.4.6 Lab function

### Reduced operator guidance => "Profi-Mode"

This function may be used for routine analyses with many samples of one method. The following information is always stored in the methods:

- Method
- Range
- Date and time
- Differentiation of results
- Detailed operator instruction
- Compliance with reaction periods

If the Profi-Mode is active, the photometer provides only a minimum of operator instructions. The criteria specified above in d, e, f are no longer included.



Press [MODE], [Shift] + [5][0] keys in succession.



Confirm with [↵] key.

**<Profi-Mode>**  
**ON : 1 OFF : 0**

The display shows:



- Press [Shift] + [0] keys to switch the Profi-Mode off.



- Press [Shift] + [1] keys to switch the Profi-Mode on.

**switched off**

The display shows:

or

**switched on**



Confirm with [↵] key.

Note:

Storage of test results is possible. When results are stored the display also shows "Profi-Mode".

The selected settings are kept by the photometer even when it is switched off. To change photometer setting a new setting is required.

## One Time Zero (OTZ)

OneTimeZero is available for all methods where Zero is performed in a 24 mm Ø round vial with sample water (see chapter 1.1 Table of Methods).

OneTimeZero can be used for different tests providing the tests are performed with the same sample water and under the same test conditions. When changing the method, it is not necessary to perform a new Zero. The test can be carried out straight away.

When the instrument is first being used for an OTZ compatible method and OneTimeZero is activated, the instrument will request a new Zero with "prepare OT-Zero". Perform Zero as described in the method. This Zero will be stored and used for all methods with OTZ function until the instrument is switched off.

If necessary, a new Zero can be performed by pressing [Zero] key at any time.

### Switching the "OTZ-Function" on and off:



Press [MODE], [Shift] + [5][5] keys.



Confirm with [↵] key.

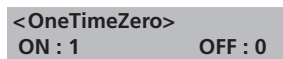

The display shows:



- Press [Shift] + [0] keys to switch the OTZ off.



- Press [Shift] + [1] keys to switch the OTZ on.



The display shows:

or

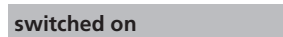

Confirm with [↵] key.

The instrument goes back to mode menu automatically.

### Note:

The specified accuracy is valid for all test results when Zero is performed for each test (OneTimeZero function is switched off).

## 2.4.7 User operations

### User method list

After switching on the instrument a scroll list of all available methods is automatically shown in the display. To shorten this list according to the requirements of the user it is possible to create a user defined scroll list.

The program structure requires that this list must have at least one active (switched on) method. For this reason it is necessary to activate first all required methods and then to switch off the automatically activated one if this method is not required.

### User-method list, adaptation



Press [MODE], [Shift] + [6][0] keys.



Confirm with [↵] key.

```
<Method list>
selected: •
toggle: F2
save: ↵
cancel: ESC
```

The display shows:

Start with [↵] key.

```
<Method list>
>> 30•Alkalinity-tot
    40•Aluminium
    50•Ammonium
....
```

The complete method list is displayed.

Methods with a point [•] behind the method number will be displayed in the method selection list. Methods without a point will not be displayed in the method selection list.

```
>> 30•Alkalinity-tot
```



Press key [▲] or [▼] to select the required method from the displayed list.

```
>> 30 Alkalinity-tot
```



Switch with [F2] key between "active" [•] and "inactive" [ ].

```
>> 30•Alkalinity-tot
```

Select next method, activate or inactivate it and continue.



Confirm with [↵] key.

Cancel without storing by pressing [ESC] key.

### Recommendation:

If only a few methods are required it is recommended to perform Mode 62 first, followed by Mode 60.

All user Polynomials (1-25) and Concentrations (1-10) are displayed in the method list, although they are not programmed by the user. Non-programmed user methods can't be activated!



## User method list, switch all methods on

This mode function activates all methods. After switching on the instrument a scroll list of all available methods is automatically shown in the display.



Press [MODE], [Shift] + [6][1] keys.



Confirm with [↵] key.

**<Mlist all on>**  
**switch on all**  
**methods**  
**YES: 1, NO: 0**

The display shows:



- Press [Shift] + [1] keys to display all methods in the method selection list.



- Press [Shift] + [0] keys to keep the valid method selection list.

The instrument goes back to mode menu automatically.

## User method list, switch all methods off

The program structure requires that the method list must have at least one active (switched on) method. For this reason the instrument activates one method automatically.



Press [MODE], [Shift] + [6][2] keys.



Confirm with [↵] key.

**<Mlist all off>**  
**switch off all**  
**methods**  
**YES: 1, NO: 0**

The display shows:



- Press [Shift] + [1] keys to display only one method in the method selection list.



- Press [Shift] + [0] keys to keep the valid method selection list.

The instrument goes back to mode menu automatically.

## User Concentration Methods

It is possible to enter and store up to 10 User Concentration Methods.

Therefore you need 2 to 14 standards of known concentration and one blank (deionised water or reagent blank value). The Standards should be measured with increasing concentrations and from the brightest to the darkest colouration.

The measuring range for „Underrange“ and „Overrange“ is defined with  $-2600 \text{ mAbs}^*$  and  $+2600 \text{ mAbs}^*$ . After selection of a method the concentration of the lowest and highest used standard is displayed as measuring range. The operation range should be within this range to achieve best results.

\*1000 mAbs = 1 Abs = 1 E (displayed)

### Entering a User Concentration:



Press [MODE], [Shift] + [6][4] keys.



Confirm with [↵] key.

< User concentr.>  
choose no.: \_\_\_\_  
(850-859)

The display shows:



Enter a method number in the range from 850 to 859, e.g.: [Shift] + [8][5][0]



Confirm with [↵] key.

Overwrite conc. meth.?  
YES: 1, NO: 0

#### Note:

if the entered number has already been used to save a concentration the display shows the query:

- Press [Shift] + [0] or [ESC] keys to go back to method no. query.
- Press [Shift] + [1] keys to start entry mode.

wavelength:  
1: 530 nm      4: 430 nm  
2: 560 nm      5: 580 nm  
3: 610 nm      6: 660 nm

Enter the required wavelength, e.g.: [Shift] + [2] for 560 nm.



choose unit:  
>>  
mg/l  
g/l  
mmol/l  
mAbs  
µg/l  
E  
A  
%

Press [▲] or [▼] keys to select the required unit.



Confirm with [↵] key.

**choose resolution**

- 1: 1
- 2: 0.1
- 3: 0.01
- 4: 0.001



Press the appropriate numerical key to select the required resolution, e.g.: [Shift] + [3] for 0.01.

**Note:**

Please enter the required resolution according to the instrument pre-sets:

range	max. resolutions
0.000 ...9.999	0.001
10.00 ...99.99	0.01
100.0... 999.9	0.1
1000 ...9999	1

## Measurement procedure with standards of known concentration:

< User concentr.>  
prepare Zero  
press ZERO



The display shows:

Prepare Zero and press [Zero] key.

**Note:**

Use deionised water or reagent blank value.

< User concentr.>  
Zero accepted  
S1: + \_\_\_\_\_  
⏪ | ESC | F1

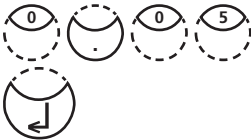

The display shows:

Enter the concentration of the first standard; e.g.: [Shift] + [0].[.] [0][5]

- One step back with [ESC].
- Press [F1] key to reset numerical input.

Confirm with [⏪] key.

< User concentr.>  
S1: 0.05 mg/l  
prepare  
press TEST



The display shows:

Prepare the first standard and press [Test] key.

S1: 0.05 mg/l  
mAbs: 12 ⏪

The display shows the input value and the measured absorption value. Confirm with [⏪] key.

S1 accepted  
S2: + \_\_\_\_\_  
⏪ | ESC | F1

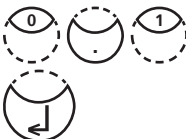

Enter the concentration of the second standard; e.g.: [Shift] + [0].[.] [1]

- One step back with [ESC].
- Press [F1] key to reset numerical input.

Confirm with [⏪] key.

S2: 0.10 mg/l  
prepare  
press TEST

S2: 0.10 mg/l  
mAbs: 150 ↵

S2 accepted  
S3: + \_\_\_\_\_  
↵ | ESC | F1 | Store



stored!

Prepare the second standard and press [Test] key.

The display shows the input value and the measured absorption value. Confirm with [↵] key.

**Note:**

- Perform as described above to measure further standards.
- The minimum of measured standards is 2.
- The maximum of measured standards is 14 (S1 to S14).

If all required standards or the maximum value of 14 standards are measured press [Store] key.

The display shows:

The instrument goes back to the mode menu automatically.

Now the concentration is stored in the instrument and can be recalled by entering its method number or selecting it from the displayed method list.

**TIP:**

Save all your concentration data in a written form because in case of power outage (e.g. changing the battery) all concentration data will be lost and must be entered again. You might want to use Mode 67 to transfer all concentration data to a PC.

## User Polynomials

It is possible to enter and store up to 25 User Polynomials.

The program allows the user to apply a Polynomial up to the 5th degree:

$$y = A + Bx + Cx^2 + Dx^3 + Ex^4 + Fx^5$$

If only a Polynomial of a lower degree is necessary the other coefficients are specified as zero (0), e.g.: for the 2nd degree is D, E, F = 0.

The values of the coefficients A, B, C, D, E, F must be entered in an academic notation with maximal 6 decimal places, e.g.: 121,35673 = 1,213567E+02

### Entering a User Polynomial:



Press [MODE], [Shift] + [6][5] keys.



Confirm with [↵] key.

<User polynoms>  
choose no.: \_\_\_\_  
(800-824)

The display shows:



Enter a method number in the range from 800 to 824, e.g.: [Shift] + [8][0][0]



**Overwrite polynomial?**  
**YES: 1, NO: 0**

**wavelength:**  
**1: 530 nm      4: 430 nm**  
**2: 560 nm      5: 580 nm**  
**3: 610 nm      6: 660 nm**



< User polynoms >  
 $y = A+Bx+Cx^2+Dx^3+Ex^4+Fx^5$   
**A: + \_\_\_\_\_**



**A: 1.32 \_\_\_\_\_ E+ \_\_\_\_\_**



**B: + \_\_\_\_\_**



**measurement range**  
**Min mAbs: + \_\_\_\_\_**  
**Max mAbs: + \_\_\_\_\_**



Confirm with [↵] key.

**Note:**

if the entered number has already been used to save a polynomial the display shows the query:

- Press [Shift] + [0] or [ESC] keys to go back to method no. query.
- Press [Shift] + [1] keys to start entry mode.

Enter the required wavelength, e.g.: [2] for 560 nm.

- Press [▲] or [▼] key to change between plus and minus sign
- Enter data of the coefficient A including decimal point, e.g.: [Shift] + [1][.][3][2]
- Press [F1] key to reset numerical input.

Confirm with [↵] key.

- Press [▲] or [▼] key to change between plus and minus sign
- Enter the exponent of the coefficient A, e.g.: [Shift] + [3]

Confirm with [↵] key.

Successively the instrument queries the data for the other coefficients (B, C, D, E and F).

**Note:**

If zero [0] is entered for the value of the coefficient, the input of the exponent is omitted automatically.

Confirm every input with [↵] key.

Enter measurement ranges from –2600 to +2600 mAbs.

- Press [▲] or [▼] key to change between plus and minus sign.
- Enter the values in Absorbance (mAbs) for the upper limit (Max) and the lower limit (Min).

Confirm every input with [↵] key.

**choose unit:**

&gt;&gt;

mg/l  
g/l  
mmol/l  
mAbs  
µg/l  
E  
A  
%

Press [▲] or [▼] keys to select the required unit.



Confirm with [↵] key.

**choose resolution**

1: 1  
2: 0.1  
3: 0.01  
4: 0.001

Press the appropriate numerical key to select the required resolution, e.g.: [Shift] + [3] for 0.01.

**Note:**

Please enter the required resolution according to the instrument pre-sets:



range	max. resolutions
0.000 ...9.999	0.001
10.00 ...99.99	0.01
100.0... 999.9	0.1
1000 ...9999	1

**stored!**

The display shows:

The instrument goes back to the mode menu automatically.

Now the polynomial is stored in the instrument and can be recalled by entering its method number or selecting it from the displayed method list.

**TIP:**

Save all your polynomial data in a written form because in case of power outage (e.g. changing the battery) all polynomial data will be lost and must be entered again. You might want to use Mode 67 to transfer all polynomial data to a PC.

## Delete User Methods (Polynomial or Concentration)

In principle a valid user method can be overwritten.

An existing user method (Polynomial or Concentration) can be totally deleted as well and is removed out of the method selection list:



Press [MODE], [Shift] + [6][6] keys.



Confirm with [↵] key.

<User m. clear>  
choose no.: \_\_\_\_\_  
(800-824), (850-859)

The display shows:



Enter the number of the User Method you want to delete (in the range from 800 to 824 or 850 to 859), e.g.: [Shift] + [8][0][0]



Confirm with [↵] key.

M800  
delete?  
YES: 1, NO: 0

The query is displayed:



- Press [Shift] + [1] keys to delete the selected User Method.



- Press [Shift] + [0] keys to keep the valid User Method.

The instrument goes back to mode menu automatically.

## Print Data of User Methods (Polynomials & Concentration)

With this Mode function all data (e.g. wavelength, unit ...) of stored user polynomials and concentration methods can be printed out or transferred with HyperTerminal to a PC.



Press [MODE], [Shift] + [6][7] keys.



Confirm with [↵] key.

<User m. print>  
Start: ↵

The display shows:



Press [↵] key to print out the data (e.g. wavelength, unit, ...) of all stored User Methods.

M800  
M803  
...

The display shows e.g.:

After data transfer the photometer goes back to mode menu automatically.



## Initialise User Method System (Polynomials & Concentration)

Power loss will cause incoherent data. The user method system must be initialised with this mode function to set it to a predefined state.

### ATTENTION:

All stored user methods (polynomial & concentration) are deleted with initialisation.



Press [MODE], [Shift] + [6][9] keys.



Confirm with [↵] key.

<User m. init>  
Start: ↵

The display shows:



Confirm with [↵] key.

Initialising?  
YES: 1, NO: 0

The query is displayed:



- Press [Shift] + [1] keys to start initialisation.



- Press [Shift] + [0] keys to cancel without initialisation.

The instrument goes back to mode menu automatically.

## 2.4.8 Special functions

### Langelier Saturation Index (Water Balance)

For calculation the following tests are required:

- pH-value
- Temperature
- Calcium hardness
- Total Alkalinity
- TDS (Total Dissolved Solids)

Run each test separately and note the results.

Calculate the Langelier Saturation Index as described:

### Calculation of Langelier Saturation Index



With Mode 71 (see below) it is possible to select between degree Celsius or degree Fahrenheit.

Press [MODE], [Shift] + [7][0] keys.



Confirm with [↵] key.

**<Langelier>**  
**temperature °C:**  
**3°C <=T<=53°C**  
+ \_ \_ \_ \_

The display shows:

Enter the temperature value (T) in the range between 3 and 53°C and confirm with [↵] key. If °F was selected, enter the temperature value in the range between 37 and 128°F.



**calcium hardness**  
**50<=CH<=1000**  
+ \_ \_ \_ \_

The display shows:

Enter the value for Calcium hardness (CH) in the range between 50 and 1000 mg/l CaCO<sub>3</sub> and confirm with [↵] key.



**tot. alkalinity**  
**5<=TA<=800**  
+ \_ \_ \_ \_

The display shows:

Enter the value for Total Alkalinity (TA) in the range between 5 and 800 mg/l CaCO<sub>3</sub> and confirm with [↵] key.



**total dissol. solids**  
**0<=TDS<=6000**  
+ \_ \_ \_ \_

The display shows:

Enter the value for TDS (Total Dissolved Solids) in the range between 0 and 6000 mg/l and confirm with [↵] key.



pH value  
0<=pH<=12  
+ \_ \_ \_ \_



The display shows:

Enter the pH-value in the range between 0 and 12 and confirm with [↵] key.

<Langelier>  
Langelier  
saturation index  
0.00  
Esc ↵

The display shows the Langelier Saturation Index.

Press [↵] key to start new calculation.

Return to mode menu by pressing [ESC] key.

**Examples:**

CH<=1000 mg/l CaCO3!

Values out of defined range:

The entered value is too high.

CH>=50 mg/l CaCO3!

The entered value is too low.



Confirm display message with [↵] key and enter a value in the defined range.

**Operating error:**

Selection of temperature unit

Entering the temperature value is possible in degree Celsius or degree Fahrenheit. Therefore the following preselection is (once) required.



Press [MODE], [Shift] + [7][1] keys.



Confirm with [↵] key.

<temperature>  
1: °C 2: °F

The display shows:



Press [Shift] + [1] keys to select degree Celsius.



Press [Shift] + [2] keys to select degree Fahrenheit.

The instrument goes back to mode menu automatically.

## 2.4.9 Instrument basic settings 2

### Adjusting display contrast



Press [MODE], [Shift] + [8][0] keys.



Confirm with [↵] key.

<LCD contrast>

The display shows:

1 ↑ 1 ↓



- Press arrow key [▲] to increase contrast of the LCD display about one unit.



- Press arrow key [▼] to decrease contrast of the LCD display about one unit.

10 ↑ 10 ↓



- Press [Store] key to increase contrast of the LCD display about ten units.



- Press [Test] key to decrease contrast of the LCD display about ten units.



Confirm with [↵] key.

### Adjusting display brightness



Press [MODE] [8] [1] keys.



Confirm with [↵] key.

<LCD brightness>

The display shows:

1 ↑ 1 ↓



Press [▲] key to increase brightness of the display about one unit.



Press [▼] key to decrease brightness of the display about one unit.

10 ↑ 10 ↓



Press [Store] key to increase brightness of the display about ten units.



Press [Test] key to decrease brightness of the display about ten units.

0...254 : 200

The display shows:

The brightness can be selected between 0 and 254 units, e.g.: 200.



Confirm with [↵] key.

## 2.4.10 Instrument special functions /service

### Photometer-Information



Press [MODE], [Shift] + [9][1] keys.



Confirm with [↵] key.

**<System-Info>**  
**Software:**  
**V201.001.1.001.002**  
**more: ↓, cancel: Esc**

This method informs you about the current software version, about the number of performed tests and free memory capacity.



Press arrow key [▼] to display the number of performed tests and free memory capacity.

**<System-Info>**  
**Number of Tests:**  
**139**  
**free records left**  
**999**  
**cancel: Esc**

Finish with [ESC] key.

## 2.5 Data transfer

To print data or to transmit to a PC the optional IRIM (Infra-Red Interface Module) is required.

### 2.5.1 Data Printing

Besides the IRIM module the following printer is required to print data directly using the USB Interface of the module: HP Deskjet 6940.

### 2.5.2 Data transfer to a personal computer

Besides the IRIM a transfer program, is required to transmit test results.

Please find detailed information in the IRIM manual or at our homepage in the download-area.

### 2.5.3 Internet Updates

To connect the instrument to the serial interface of a computer the optional connection cable with integrated electronic system is required.

It is possible to update new software applications and additional languages via the internet. Please find detailed information at our homepage in the download-area (as soon as available).

How to open and close the battery compartment cover see chapter 2.1.3!

#### **Please Note:**

To prevent loss of stored test results store or print them out before performing an Update. If the update procedure is interrupted (eg. interruption of connection, LoBat., etc.) the instrument isn't able to work (no display). The instrument will only work again after completing the data transfer.

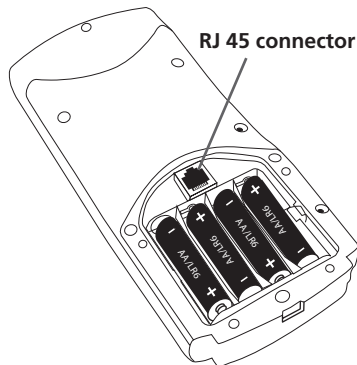

# **Part 3**

# **Enclosure**

## 3.1 Unpacking

Carefully inspect all items to ensure that every part of the list below is present and no visible damage has occurred during shipment. If there is any damage or something is missing, please contact your local distributor immediately.

## 3.2 Delivery contents

Standard contents for MD 600:

- 1 Photometer in plastic case
- 4 batteries (Type AA/LR 6)
- 1 Instruction manual
- 1 Guarantee declaration
- 1 Certificate of compliance
- Adapter for 16 mm Ø vials
- Adapter for 13 mm Ø vials
- Round vials with cap, height 48 mm, Ø 24 mm
- Round vials with cap, height 90 mm, Ø 16 mm
- Cleaning brush
- Stirring rod, plastic

Reagent sets, IRIM module and connection cable with integrated electronic system are not part of the standard scope of delivery. Please see the General Catalogue for details of available reagent sets.

## 3.3 blank because of technical requirements



### 3.4 Technical data

Display	Graphic Display with backlight
Serial Interface	IR interface for data transfer RJ45 connector for internet updates (see chapter 2.5.3)
Light source	light-emitting diode – photosensor – pair arrangement in a transparent measurement chamber Wavelength ranges: $\lambda_1 = 530 \text{ nm IF } \Delta \lambda = 5 \text{ nm}$ $\lambda_2 = 560 \text{ nm IF } \Delta \lambda = 5 \text{ nm}$ $\lambda_3 = 610 \text{ nm IF } \Delta \lambda = 6 \text{ nm}$ $\lambda_4 = 430 \text{ nm IF } \Delta \lambda = 5 \text{ nm}$ $\lambda_5 = 580 \text{ nm IF } \Delta \lambda = 5 \text{ nm}$ $\lambda_6 = 660 \text{ nm IF } \Delta \lambda = 5 \text{ nm}$ IF = Interference filter
Wavelength accuracy	$\pm 1 \text{ nm}$
Photometric accuracy*	2% FS (T = 20°C – 25°C)
Photometric resolution	0.005 A
Measuring range of absorbance	-2600 - 2600 mAbs
Protection	conforming to IP 68 (1 h, 0.1 m)
Operation	Acid and solvent resistant touch-sensitive keyboard with integral beeper as acoustic indicator.
Power supply	4 batteries (Type AA/LR 6); lifetime: approx. 26 hours continuous use or 3500 tests
Auto off	20 minutes after last function, 30 seconds acoustical signal before switch off
Dimensions	approx. 210 x 95 x 45 mm (unit) approx. 395 x 295 x 106 mm (case)
Weight (unit)	approx. 450 g
Working condition	5 – 40°C at max. 30–90% relative humidity (without condensation)
Language options	English, German, French, Spanish, Italian, Portuguese, Polish; further languages via Internet Update
Storage capacity	ca. 1000 data sets

\* *measured with standard solutions*

#### **Subject to technical modification!**



**To ensure maximum accuracy of test results, always use the reagent systems supplied by the instrument manufacturer.**

### 3.5 Abbreviations

Abbreviation	Definition
°C	degree Celsius (Centigrade)
°F	degree Fahrenheit $^{\circ}\text{F} = (^{\circ}\text{C} \times 1.8) + 32$
°dH	degree German Hardness
°fH	degree French hardness
°eH	degree English Hardness
°aH	degree American Hardness
Abs	Absorption unit ( $\triangleq$ Extinction E) 1000 mAbs = 1 Abs $\triangleq$ 1 A $\triangleq$ 1 E
µg/l	(= ppb) Microgram per litre
mg/l	(= ppm) Milligram per litre
g/l	(= ppth) gram per litre
KI	Potassium iodide
K <sub>S4.3</sub>	Acid demand to pH 4.3 – this method is similar to Total Alkalinity but converted into the unit “mmol/l”, as the German DIN 38409 demand.
TDS	Total Dissolved Solids
LR	Low Range
MR	Medium Range
HR	High Range
C	Reagents from Chemetrics®
L	Liquid reagent
P	Powder (reagent)
PP	Powder Pack
T	Tablet
TT	Tube Test
DEHA	N,N-Diethylhydroxylamine
DPD	Diethyl-p-phenyldiamine
DTNB	Ellmans reagent
PAN	1-(2-Pyridylazo)-2-naphthol
PDMAB	Paradimethylaminobenzaldehyde
PPST	3-(2-Pyridyl)-5,6-bis(4-phenylsulfonic acid)1,2,4-triazine
TBPE	Tetrabromophenolphthalein Ethyl Ester Potassium Salt
TPTZ	2,4,6-Tri-(2-Pyridyl)-1,3,5-triazine

## 3.6 Troubleshooting

### 3.6.1 Operating messages in the display / error display

Display	Possible Causes	Elimination
Overrange	reading is exceeding the range water sample is too cloudy too much light on the photo cell	if possible dilute sample or use other measuring range filtrate water sample seal on the cap? Repeat measurement with seal on the cap of the vial.
Underrange	result is under the detection limit	indicate result with lower x mg/l x = low end of measuring range; if necessary use other analytical method
Storagesystem error use Mode 34	mains power fails or is not connected	insert or change battery. Delete data with Mode 34
Battery warning 	warning signal every 3 minutes warning signal every 12 seconds	capacity of the battery is too low; change the batteries
	warning signal, the instrument switches itself off	change the batteries
Jus Overrange E4	The user calibration is out of the accepted range	Please check the standard, reaction time and other possible faults. Repeat the user calibration.
Jus Underrange E4		
Overrange E1	The concentration of the standard is too high/too low, so that during user calibration the limit of the range was exceeded	Perform the test with a standard of higher/lower concentration
Underrange E1		
E40 user calibration not possible	If the display shows Overrange/ Underrange for a test result a user calibration is not possible	Perform the test with a standard of higher/lower concentration
Zero not accepted	Light absorption is too great or too low	Refer to chapter 2.3.4 Performing Zero. Clean sample chamber. Repeat zeroing.

Display	Possible Causes	Elimination																		
<p data-bbox="120 181 165 213">???</p> <p data-bbox="109 309 202 335">Example 1</p> <table data-bbox="116 360 300 453"> <tr> <td>0,60 mg/l</td> <td>free Cl</td> </tr> <tr> <td>???</td> <td>comb Cl</td> </tr> <tr> <td>0,59 mg/l</td> <td>total Cl</td> </tr> </table> <p data-bbox="109 560 202 585">Example 2</p> <table data-bbox="116 611 300 703"> <tr> <td>Underrange</td> <td></td> </tr> <tr> <td>???</td> <td>comb Cl</td> </tr> <tr> <td>1,59 mg/l</td> <td>total Cl</td> </tr> </table> <p data-bbox="109 852 202 877">Example 3</p> <table data-bbox="116 903 300 995"> <tr> <td>0,60 mg/l</td> <td>free Cl</td> </tr> <tr> <td>???</td> <td>comb Cl</td> </tr> <tr> <td>Overrange</td> <td></td> </tr> </table>	0,60 mg/l	free Cl	???	comb Cl	0,59 mg/l	total Cl	Underrange		???	comb Cl	1,59 mg/l	total Cl	0,60 mg/l	free Cl	???	comb Cl	Overrange		<p data-bbox="327 172 575 252">The calculation of a value (e.g. combined Chlorine) is not possible</p>	<p data-bbox="620 172 833 225">Test procedure correct? If not – repeat test</p> <p data-bbox="620 309 911 496">Example 1: The readings for free and total Chlorine are different, but considering the tolerances of each reading they are the same. For this reason the combined Chlorine is most likely zero.</p> <p data-bbox="620 564 911 772">Example 2: The reading for free Chlorine is under the detection limit. The instrument is not able to calculate the combined Chlorine. In this case the combined Chlorine is most likely the same as the total Chlorine.</p> <p data-bbox="620 852 911 1038">Example 3: The reading for total Chlorine is exceeding the range. The instrument is not able to calculate the combined Chlorine. The test should be repeated with a diluted sample.</p>
0,60 mg/l	free Cl																			
???	comb Cl																			
0,59 mg/l	total Cl																			
Underrange																				
???	comb Cl																			
1,59 mg/l	total Cl																			
0,60 mg/l	free Cl																			
???	comb Cl																			
Overrange																				
<p data-bbox="109 1102 266 1155">Error absorbance e.g.: T2&gt;T1</p>	<p data-bbox="327 1102 575 1155">Fluoride calibration was not correct</p>	<p data-bbox="620 1102 788 1128">Repeat calibration</p>																		

### 3.6.2 General

<b>Finding</b>	<b>Possible Causes</b>	<b>Elimination</b>
Test result deviates from the expected.	Chemical species not as required.	Press arrow keys to select the required chemical species.
No differentiation: e.g. for the Chlorine test there is no selection between differentiated, free or total.	Profi-Mode is switched on.	Switch Profi-Mode off with Mode 50.
The pre-programmed countdown is not displayed.	Countdown is not activated and/or the Profi-Mode is activated.	Switch the countdown on with Mode 13 and/or switch the Profi-Mode off with Mode 50.
It seems that a method is not available.	Method is not activated in the user method list.	Activate the required method in the user method list with Mode 60.

Konformitätserklärung mit gefordertem Inhalt gemäß EN ISO/IEC 17050-1  
 Supplier's declaration of conformity in accordance with EN ISO/IEC 17050-1

## EU-Konformitätserklärung / EU-Declaration of Conformity

Dokument-Nr. / Monat:Jahr: 2 / 12.2017  
 Document No. / Month:Year:

Für das nachfolgend bezeichnete Erzeugnis / For the following mentioned product

Bezeichnung / Name, Modellnummer / Model No.	MD 600 AL 400 PM 600 PM620 , 214020, 4214020, 214060, 214065
---	--

wird hiermit erklärt, dass es den grundlegenden Anforderungen entspricht, die in den nachfolgend bezeichneten Harmonisierungsrechtsvorschriften festgelegt sind: / It is hereby declared that it complies with the essential requirements which are determined in the following harmonisation rules:

Richtlinie 2014/30/EU des Europäischen Parlaments und des Rates vom 26. Februar 2014 zur Harmonisierung der Rechtsvorschriften der Mitgliedstaaten über die elektromagnetische Verträglichkeit . Directive 2014/30/EU of the European Parliament and of the Council of 26 February 2014 on the harmonisation of the laws of the Member States relating to electromagnetic compatibility .
RICHTLINIE 2011/65/EU DES EUROPÄISCHEN PARLAMENTS UND DES RATES vom 8. Juni 2011 zur Beschränkung der Verwendung bestimmter gefährlicher Stoffe in Elektro- und Elektronikgeräten (Neufassung) DIRECTIVE 2011/65/EU OF THE EUROPEAN PARLIAMENT AND OF THE COUNCIL of 8 June 2011 on the restriction of the use of certain hazardous substances in electrical and electronic equipment (recast)

Angabe der einschlägigen harmonisierten Normen, die zugrunde gelegt wurden, oder Angabe der Spezifikationen, für die die Konformität erklärt wird: / Information of relevant harmonised standards and specifications on which the conformity is based:

Fundstelle / Reference	Ausgabedatum/ Edition	Titel / Title
Harmonisierte Normen / Harmonised Standards		
DIN EN 61326-1	2013-07	Elektrische Mess-, Steuer-, Regel- und Laborgeräte - EMV-Anforderungen - Teil 1: Allgemeine Anforderungen (IEC 61326-1:2012)
DIN EN 50581	2013-02	Technische Dokumentation zur Beurteilung von Elektro- und Elektronikgeräten hinsichtlich der Beschränkung gefährlicher Stoffe; Deutsche Fassung EN 50581:2012

Weitere angewandte technische Spezifikationen (z.B. nicht im EU-Amtsblatt veröffentlicht) / Further applied technical specifications (e.g. not published in the Official Journal of the EU)

Diese Erklärung wird verantwortlich für den Hersteller oder seinem Bevollmächtigten / This declaration is made for and on behalf of the manufacturer or his representatives

Name:	Tintometer GmbH
Anschrift / Address:	Schleefstr. 8-12, 44287 Dortmund, Germany

abgegeben durch / declared by

Name, Vorname / First name:	Dr. Grabert, Elmar
Funktion / Function:	Technische Leitung / Director Technology

Bevollmächtigte Person im Sinne des Anhangs II Nr. 1. A. Nr. 2, 2006/42/EG für die Zusammenstellung der technischen Unterlagen / Authorized person for compilation of technical documents on behalf of Annex II No. 1. A. No. 2, 2006/42/EC:

Name:	Corinna Meier
Anschrift / Address:	c/o Tintometer GmbH, Schleefstr. 8-12, 44287 Dortmund

Dortmund 19.12.2017



Ort, Datum / Place and date of issue

Rechtsgültige Unterschrift / Authorized signature

Diese Erklärung bescheinigt die Übereinstimmung mit den so genannten Harmonisierungsrechtsvorschriften, beinhaltet jedoch keine Zusicherung von Eigenschaften. / This declaration certifies the conformity to the specified directives but contains no assurance of properties.

### Zusatzangaben / Additional details:

Diese Erklärung gilt für alle Exemplare, die nach den entsprechenden Fertigungszeichnungen - die Bestandteil der technischen Unterlagen sind - hergestellt werden. Weitere Angaben über die Einhaltung obiger Fundstellen enthält die beiliegende Konformitätsaussage unterstützende Begleitdokumentation. / This statement is valid for all copies which were manufactured in accordance with the technical drawings which are part of the technical documentation. More details about compliance of the above mentioned references includes the supporting documentation.

Doc file:

MD 600 AL 400 PM 600 PM620 DoAnw\_2\_12\_2017



**Tintometer GmbH**

Lovibond® Water Testing  
Schleefstraße 8-12  
44287 Dortmund  
Tel.: +49 (0)231/94510-0  
sales@lovibond.com  
www.lovibond.com  
Germany

**The Tintometer Limited**

Lovibond House  
Sun Rise Way  
Amesbury, SP4 7GR  
Tel.: +44 (0)1980 664800  
Fax: +44 (0)1980 625412  
water.sales@lovibond.uk  
www.lovibond.com  
UK

**Tintometer Inc.**

6456 Parkland Drive  
Sarasota, FL 34243  
Tel: 941.756.6410  
Fax: 941.727.9654  
sales@lovibond.us  
www.lovibond.us  
USA

**Tintometer Spain**

Postbox: 24047  
08080 Barcelona  
Tel.: +34 661 606 770  
sales@tintometer.es  
www.lovibond.com  
Spain

**Tintometer China**

9F, SOHO II C.  
No.9 Guanghualu,  
Chaoyang District,  
Beijing, 100020  
Customer Care China Tel.:  
4009021628  
Tel.: +86 10 85251111 Ext. 330  
Fax: +86 10 85251001  
chinaoffice@tintometer.com  
www.lovibond.com  
China

**Tintometer South East Asia**

Unit B-3-12, BBT One Boulevard,  
Lebu Nilam 2, Bandar Bukit Tinggi,  
Klang, 41200, Selangor D.E  
Tel.: +60 (0)3 3325 2285/6  
Fax: +60 (0)3 3325 2287  
lovibond.asia@lovibond.com  
www.lovibond.com  
Malaysia

**Tintometer Brazil**

Caixa Postal: 271  
CEP: 13201-970  
Jundiaí – SP  
Tel.: +55 (11) 3230-6410  
sales@lovibond.us  
www.lovibond.com.br  
Brazil

**Tintometer Indien Pvt. Ltd.**

Door No: 7-2-C-14, 2<sup>nd</sup>, 3<sup>rd</sup> & 4<sup>th</sup> Floor  
Sanathnagar Industrial Estate,  
Hyderabad: 500018, Telangana  
Tel: +91 (0) 40 23883300  
Toll Free: 1 800 599 3891/ 3892  
indiaoffice@lovibond.in  
www.lovibondwater.in  
India



Technical changes without notice  
Printed in Germany 02/24  
Lovibond® and Tintometer® are  
registered trademarks of the  
Tintometer group of companies.