

Lovibond® Water Testing

Tintometer® Group

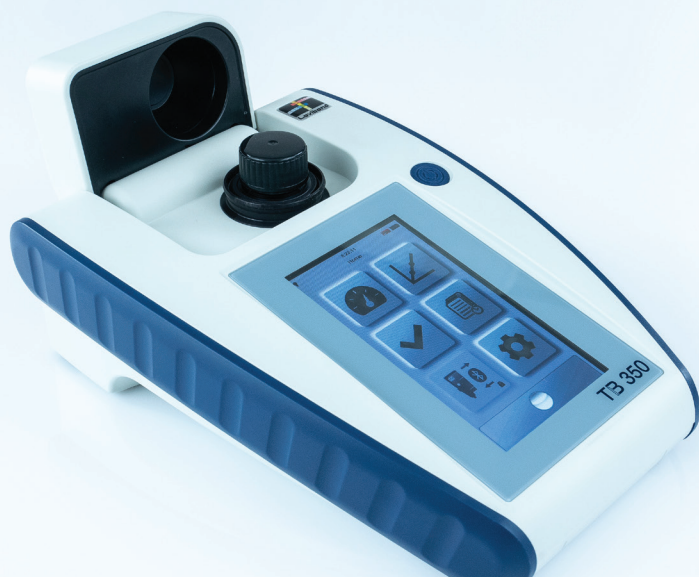

Turbidimeter



TB 350

(EN) Instruction manual.....	3	(DE) Gebrauchsanleitung.....	42
(ES) Manual de instrucciones.....	82	(FR) Mode d'emploi.....	122
(PT) Manual de instruções.....	164	(IT) Manuale d'istruzione.....	204
(NL) Gebruiksaanwijzing.....	244	(TR) Kullanım Talimatları.....	284
(RU) Инструкции по эксплуатации.....	324	(ZH) 使用说明.....	365

Table of Contents

	Page
1 Introduction	5
1.1 General Information	5
1.1.1 Read instructions before use	5
1.1.2 Purpose of the Product	5
1.1.3 Authorized use	5
1.1.4 Requirements for safe use	5
1.1.5 Keep instructions	6
1.1.6 User qualification	6
1.1.7 Handling of hazardous chemicals	6
1.1.8 Disposal notes	6
1.2 List of all used signs in the document	7
1.3 Abbreviations	7
2 Product overview	8
2.1 Certification	8
2.2 Features	9
2.3 Product description	9
2.4 Instrument view	9
3 Commissioning	11
3.1 Operating environment	11
3.2 Contents of delivery	11
3.3 Inserting and replacing the batteries	12
4 Operation	14
4.1 First start up	14
4.2 General operation principles	15
4.3 List of control elements and their function	16
4.3.1 Display Overview	16
4.3.2 Status Bar	17
4.3.3 Home Bar	19
4.4 Measurement	20
4.4.1 Measurement Overview	20
4.4.2 Performing a Measurement	21
4.4.3 Measurement Tips	22
4.4.4 Measurement Settings	23
4.5 Calibration	24
4.5.1 Calibration Overview	24
4.5.2 Performing a Calibration	24
4.5.3 Calibration Settings	25

	Page
4.6 Verification	26
4.6.1 Verification Overview	26
4.6.2 Performing a Verification	27
4.6.3 Verification Settings	27
4.7 Logs	28
4.7.1 Selecting a Log Type	28
4.7.2 Retrieving a Log	28
4.8 Instrument Settings	29
5 Maintenance	32
5.1 Recommended maintenance schedule	32
6 Troubleshooting	34
6.1 Error messages and what to do	34
7 Accessories & Replacement parts	36
7.1 List of Accessories	36
7.2 Replacement Parts	36
8 Specifications	37
8.1 Specifications - Mains adapter	39
9 Appendix	41
9.1 List of Trademarks	41

1 Introduction

1.1 General Information

1.1.1 Read instructions before use

This manual provides important information on the safe operation of the product. Please read this manual carefully and familiarize yourself with the product before use.

1.1.2 Purpose of the Product

The TB Series Portable Turbidimeter is designed to analyze aqueous samples that are collected into a glass vial that is then capped. The vial is prepared for measurement using a scrupulous technique to minimize interferences from dust and scratches. Once prepared, the vial is placed in the instrument for measurement.

The instrument can be used in the laboratory or taken to the field to perform measurements on samples as they are collected.

The handling of this turbidimeter should be done with care during any transport. If the instrument is taken into the field, the carrying case should be used. If used for regulatory applications, consultation with the local regulatory authorities is advised to ensure the correct model of instrument is selected.

1.1.3 Authorized use

The manufacturer's liability and warranty for damage is voided with improper use, failure to follow this manual, use by unqualified personnel, or unauthorized changes to the product.

The manufacturer is not liable for costs or damages that arise from the user or third parties due to the use of this product, especially in cases of improper use of the product or misuse or faults in the connection of the product.

The manufacturer assumes no liability for print errors.

1.1.4 Requirements for safe use

Note the following points for safe use of the unit:

- If the equipment is used in a manner not specified by the manufacturer, the protection provided by the equipment may be impaired.
- The product may only be used according to the authorized use specified above.
- The product may only be supplied with power by the energy sources mentioned in this operating manual.
- The product may only be used under the environmental conditions mentioned in this operating manual.
- The product must not be opened or modified.

The product must not be used if:

- it is visibly damaged (e.g. after being transported)
- it was stored under adverse conditions for a lengthy period of time (storage conditions, see Chapter "Specifications")

Prerequisites for safe use of the plug-in power supply unit

Observe the following points for safe use:

- Check for visible damage before use. If damaged, do not put into operation.
- Use only in dry rooms.
- Handle only with dry hands.
- Only the power supply recommended by the manufacturer may be used.
- The product must not be opened or modified.
- Only the USB-C cable recommended by the manufacturer may be used to power the device.

1.1.5 Keep instructions

The manual must be kept in the vicinity of the product so you can always find the information you need.

1.1.6 User qualification

The operating personnel must be able to understand and correctly implement the safety labels and safety instructions on the packages and inserts of the products.

The user must be capable and able to read and understand this manual in order to familiarize themselves with the handling and to ensure safe use.

1.1.7 Handling of hazardous chemicals

Chemical and/or biological hazards may exist where this product is used. Abide by all governing laws, regulations and protocols when using this product.

For the development of products, Lovibond® pays close attention to safety. Some hazards from dangerous substances cannot be avoided. If self-produced tests or solutions are used, the responsibility concerning any risks caused by those tests or solutions lies with the user (personal responsibility).

For your own protection, for turbidity standards greater than 5 NTU, wearing protective gloves or goggles is recommended. Observe the relevant safety data sheet.

The safety datasheets of the chemicals comprise all instructions on safe handling, occurring hazards, preventive actions and actions to take in hazardous situations.

1.1.8 Disposal notes

Dispose of the batteries and electrical devices at a suitable facility according to local legal requirements.

It is illegal to dispose of the batteries with household waste.



Within the European Union, the batteries are removed at a specialized treatment center at the instrument's end of life.



Instruments marked with this symbol must not be disposed of in normal domestic waste.

1.2 List of all used signs in the document

The following symbols are used in this manual to identify sections that require special attention:

 Danger!	<p>A hazard exists that will result in death or severe injury if not avoided.</p>
 Warning!	<p>Improper handling of certain reagents can cause damage to your health. In any case follow the safety labels on the packing, the safety instructions of the package insert and available SDS. Protective measures specified there have to be followed exactly.</p>
 Caution!	<p>A hazard exists that may result in minor or moderate injury.</p>

1.3 Abbreviations

Abbreviation	Definition
NTU	Nephelometric Turbidity Unit
FNU	Formazin Nephelometric Units
mg/l	Milligram per liter

2 Product overview

2.1 Certification

EMC Conducted and radiated emissions	CISPR 11 (Class A Limits)	CE mark
EMC Immunity	EN 61326-1 (Industrial limits)	CE mark
Safety	EN 61010-1	TÜV safety mark
FCC	FCC Class A	FCC mark

FCC Class A Notice

This device complies with Part 15 of the FCC Rules. Operation is subject to the following two conditions:

- This device may not cause harmful interference.
- This device must accept any interference received, including interference that may cause undesired operation.

Note: This equipment has been tested and found to comply with the limits for a Class A digital device, pursuant to Part 15 of the FCC Rules. These limits are designed to provide reasonable protection against harmful interference when the equipment is operated in a commercial environment. This equipment generates, uses and can radiate radio frequency energy and, if not installed and used in accordance with the instruction manual, may cause harmful interference to radio communications. Operation of this equipment in a residential area is likely to cause harmful interference in which case the user will be required to correct the interference at their expense.

Shielded Cables



Connections between the system and its peripherals must be made using shielded cables in order to maintain compliance with FCC radio frequency emission limits.

Caution!

Modifications



Any modifications made to this device that are not approved by Tintometer may void the authority granted to the user by the FCC to operate this equipment.

Caution!

DOC Class A Notice - Avis DOC, Class A

This Class A digital apparatus meets all requirements of the Canadian Interference-Causing Equipment Regulations.

2.2 Features

Laboratory accuracy meets portability

The Lovibond® TB Series eliminates the complexities in turbidity measurement. This new technology provides the highest level of accuracy, operational and regulatory efficiencies.

- Touchscreen interface for ease of operation
- Guided routine procedures to eliminate errors
- Straightforward data management protocols to ensure data integrity

2.3 Product description

Turbidity is an expression of the optical properties of a sample that causes light rays to be scattered and absorbed rather than transmitted in straight lines through a fluidic sample. In water, turbidity is often caused by the presence of matter such as clay, silt, finely divided organic matter, plankton, other microscopic organisms, organic acids, and pigments. Turbidity measurement is used to monitor processes that remove or alter the concentrations of particles in solutions, such as in the production of drinking water. These Lovibond® turbidimeters are designed to combine high accuracy and high sensitivity that are expected of a laboratory turbidimeter with portability.

2.4 Instrument view

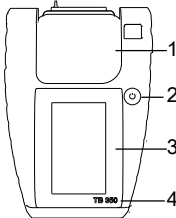
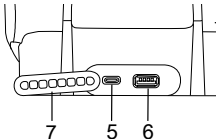
Position	Description	Function
	1. Lid	When lifted, allows the user to place the sample cell in the instrument for a reading.
	2. Power button	Powers the instrument ON and OFF.
	3. Touch Screen	Displays the user interface of the instrument.
	4. Model Number	Identifies instrument version.
	5. USB-C Port	Supplies power to the instrument from an external source or will re-charge the battery pack accessory (if installed).
	6. USB-A Port	Supports external USB-A device for functions such as data transfer or backups.
	7	
	5	
	6	

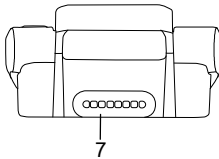
Position	Description	Function
	7. Plug	Used to cover USB-C and USB ports when connections are not in use.

EN

3 Commissioning

3.1 Operating environment

The instrument can be used in any indoor or outdoor environment that is deemed safe for an operator to perform the analysis.

The instrument can accept aqueous samples from 0 to 70 °C.

The instrument should be level $\pm 15^\circ$ when performing a measurement.

The instrument should be placed on a level surface to achieve the best measurement performance.

EN

3.2 Contents of delivery

Inspect items to ensure no damage has occurred during shipment. If there is damage or something is missing, please contact local distributor immediately.

TB	350 IR	350 WL
Instrument	X	X
Silicone Oil, 15 ml	X	X
Microfiber Cloth	X	X
2 x Sample Cells	X	X
Screwdriver	X	X
Brush	X	X
Case with insert	X	X
Quick Start Guide	X	X
Certificate of Conformity	X	X
Warranty Booklet	X	X
4 x AA Batteries	X	X
Rechargeable Battery Pack		
USB-C Cable		
AC Power Supply		
Adapter for US, UK and EU Plugs		
T-CAL [®] Standard, 5 NTU	X	X
T-CAL [®] Standard, 20 NTU	X	X
T-CAL [®] Standard, 800 NTU	X	X
T-CAL [®] Standard, 2000 NTU		X
T-CAL [®] Standard, 4000 NTU	X	X

3.3 Inserting and replacing the batteries

When using batteries

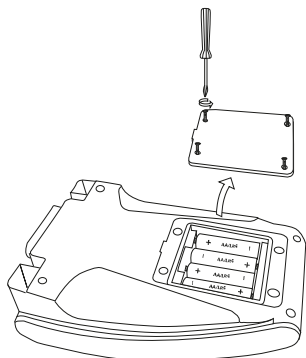

EN

Step	Description
1	Use a screwdriver to remove the four screws on the back of the instrument and remove the panel.
2	Insert four AA batteries in the correct orientation.
3	Attach the panel back onto the instrument.



Caution!

- Only use the approved type: alkaline manganese battery, LR6, with 1.5V voltage.
- Remove empty batteries from the unit as soon as possible.
- If the unit is not used for a long time, remove the batteries from the unit.

When using rechargeable battery packs

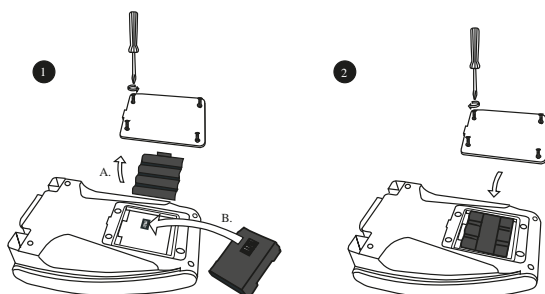

Step	Description
1	Use a screwdriver to remove the four screws on the back of the instrument, remove the panel and the battery tray.
2	Insert the rechargeable battery pack in the correct orientation.
3	Attach the panel back onto the instrument.



Warning!

The rechargeable battery pack (19820-011) is only compatible with instruments with the serial number 23041000 and higher.

Using the battery pack for instruments with serial numbers prior to 23041000 may cause the device to overheat during charging.

This overheating can lead to incorrect readings and damage to the device and must therefore be avoided.

For devices with serial numbers prior to 23041000, please contact Lovibond® for details on the use of this accessory.

4 Operation

4.1 First start up



1. Welcome Screen

Initial screen user sees upon first power on.
Press > button



2. Select Language

Select desired language to set.
Press > button



3. Set Date and Time

Choose between 12- and 24-hour format.
Change values using up and down arrows.
Press > button



4. Password

Set a user-selected password to implement security features on instrument.
Press save button.
If no password is desired, select "Skip".
Press > button



5. Default Units

Select desired unit type to set.
Press > button



6. Contact Details

Enter instrument owner information.
Press save button.
If no details are desired, select "Skip".
Press > button



7. Summary Screen

Review of initial setting.
Press < to change setting before proceeding.
Press > to proceed with the Home Screen.
User can select task to perform with instrument.

4.2 General operation principles

The designs of the TB Series Portable Turbidimeters are broken down into their respective functional components that are discussed in detail. These include the light source, the 90-degree scattered light trap, the scattered light detector, turbidimeter sample vial and how these key components work together to deliver the turbidity result.

The simplified optical configuration for the TB Series of Portable Turbidimeters. This figure shows the incident light path and the view of the 90° scattered light detector.

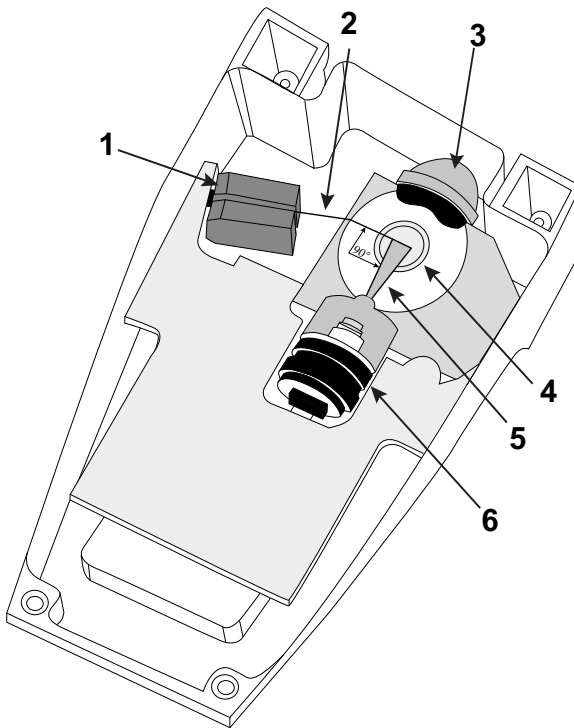





- 1 Illuminator (LED and Optics)
- 2 Incident Light Path
- 3 90° Stray Light Trap
- 4 Sample Vial
- 5 Scattered Light (10°-20° Detector View)
- 6 Scattered Light Detector and Optics



4.3 List of control elements and their function

4.3.1 Display Overview























Description	Function
1 Status Bar	Displays the icons and labels that are universal including Time, Bluetooth®, USB, Security, Light Source & Power.
2 Action Area	Area that displays application steps and interaction.
3 Home Bar	Used primarily for navigation, to start or save or dismiss actions & return Home.

Icon	Description
	Measurement Mode
	Calibration Mode
	Verification Mode
	Data Logs

Icon	Description
	Bluetooth connection to PTV process turbidimeter (not available for TB 350)
	Instrument settings

4.3.2 Status Bar









Icon	Description	Function
	Application Name	Title of the app that the user is currently using.
	Time	Time set by user in initial setup or by accessing the instrument settings. 12 hour or 24 hour format is available.
	USB	If displayed, indicates a USB module is attached to the unit.
	Bluetooth Icon - Plain ²⁾	If displayed, Bluetooth® module is attached.
	Bluetooth Icon – With arrows ²⁾	If displayed, Bluetooth® module is attached and actively communicating with a PTV or AquaLX App.
	Red Light Source – Filled	Instrument contains a red LED light source; light is switched on for measurement.
	Red Light Source – Outline	Instrument contains a red LED light source; no measurement is active.
	White Light Source – Filled	Instrument contains a white LED light source; light is switched on for measurement.
	White Light Source – Outline	Instrument contains a white LED light source; no measurement is active.



Icon	Description	Function
	Infrared Light Source – On	Instrument contains an infrared LED light source; light is switched on for measurement.
	Infrared Light Source – Off	Instrument contains an Infrared LED light source; no measurement is active.
	Laser Light Source – Filled ¹⁾	Instrument contains a laser LED light source; light is switched on for measurement.
	Laser Light Source – Outline ¹⁾	Instrument contains a laser LED light source; no measurement is active.
	AC Battery Charging	AC Battery is charging.
	AC Power Icon	Indicates instrument is powered via AC power.
	Battery Power – Green	Indicates 100% life of battery remains.
	Battery Power – Yellow	Indicates 75% of battery life remains.
	Battery Power – Orange	Indicates 50% of battery life remains.
	Battery Power - Red	Indicates 25% of battery life remains.
	Sample chamber cover open	Indicates open Sample chamber cover.
	Sample chamber cover closed	Indicates closed Sample chamber cover.

¹⁾ only TB 600

²⁾ not TB 350

4.3.3 Home Bar

Icon	Description	Function
	Home Button	Returns user to home screen.
	Home Button - Locked	Security is active; password has been enabled and is required to perform certain functions.
	Home Button - Unlocked	Security is inactive; no functions are blocked to the user.
	Save Button	Saves the content displayed in the active area.
	Settings Button	Opens the setting menu of an application.
	Export Button	Exports the log(s) displayed in the active area.
	Measurement Button	Starts or Begins or Initiates a measurement.
	Measurement Button – with Bluetooth ^{®2)}	Takes a measurement while connected to a PTV unit.
	Bluetooth [®] Refresh Button ²⁾	Refreshes the list of available PTV units within proximity of the instrument.

Icon	Description	Function
	Cancel Button	Gives option to cancel current activity in the active area.
	Right Chevron	Advance to the next step within a process.
	Left Chevron	Return to a previous step within a process.

²⁾ not TB350

4.4 Measurement

4.4.1 Measurement Overview

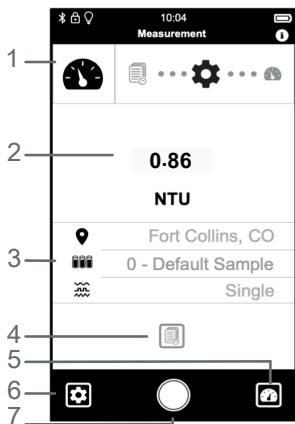

Description	Function
1 Application Bar	Navigation path to help the user through the process steps.
2 Measurement Value	Display of measured sample value with unit type.
3 Settings	Settings applied to measurement are displayed.
4 Log Button	Creates a Log when pressed.
5 Measurement Button	Starts a measurement when pressed.
6 Settings Button	Used to change settings.
7 Home Button	Returns user to home screen.

4.4.2 Performing a Measurement

Please prepare the sample cells included in the scope of delivery before measurement. Make sure that the sample cells are free of stains, scratches or blemishes.

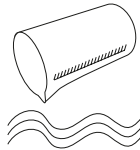

1. Collect sample

Ensure sample is representative (well mixed).
Glassware should be free of stains, scratches or other blemishes.

Rinse collection vessel at least two times with sample prior to sample collection.



2. Prepare sample cell

Using a lint free cloth, dry the exterior of the sample vial.

Use silicone oil to minimize stray light reflections.



3. Insert vial into instrument

Ensure sample is bubble free.

Invert slowly to mix. Do not shake.

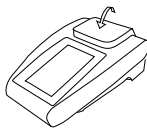

4. Close lid

Measurement will not be allowed without lid in place.



5. Check settings

Ensure the measurement settings are correct.

Settings for measurement cannot be changed after measurement occurs.



6. Press measure button

Starts Measurement.



7. Data Log

Enter Data Log to save measurement.



8. Save measurement

If desired, press Save Button in order to create a measurement log



9. Pause

Pauses the measurement in "continuous" measurement mode.



- Do not bring any objects into the measuring chamber except the cuvettes intended for the measurements.
- Do not bring any liquids into the chamber.

Warning!

4.4.3 Measurement Tips

Indexing the vial: This is best performed with a vial that is filled with water that is filtered through a 0.2 µm filter.

- Press Measurement button.
- Rotate the sample. While rotating the vial, identify the lowest reading.
- When position is determined, stop the measurement. Mark the vial.
- Before proceeding with additional measurements, ensure measurement mode is updated, as necessary.
- Indexing the sample vial is recommended if there is a noticeable scratch or pit in the glassware.

Use of Silicone Oil

- Take care to handle the vial by the top third only.
- Wipe the vial with the supplied cleaning cloth to remove water, dust and fingerprints.
- Oil the outside of the vial with silicone oil.
 - Place a very thin bead of silicone oil down the side of the vial. Evenly spread the bead of oil over the bottom 2/3's of the vial.
 - Wipe the silicone from the vial through rotation of the vial against a clean, dust-free cloth.
- Oiling cells is critical and recommended when measuring samples with an expected turbidity that is below 0.5 NTU.

Samples containing excess bubbles

- Allow sample to stand for a minimum of five minutes.
- Gently invert sample two to three times to resuspend the turbidity.
- Place in instrument and proceed as instructed.

Other Notes

- Use of ultrasonic baths is not recommended. Ultrasonic energy can change particle distribution.
- Use Fast Setting Mode for samples that have high concentrations of sands or particles of high density.

4.4.4 Measurement Settings



Press the Settings Button to access the Measurement Settings Mode.

Icon	Description	Option	Function
	Mode	Single	Push to Read.
		Continuous ¹⁾	Measurement updates every X seconds until stopped.
		Fast Settling	Recommended for samples with rapid settling characteristics.
	Location	Default	Used if no Custom ID is set.
		Custom	Custom description of measurement location and measurement limits.
	Signal Avg.	On	If on, can be set up to 255 measurements. Function should be utilized if measurements are unstable.
		Off	deactivated
	Sample ID	Default	Used if no Custom ID is set.
		Custom	Unique identifier of sample; user selectable.

¹⁾not TB350

4.5 Calibration

4.5.1 Calibration Overview

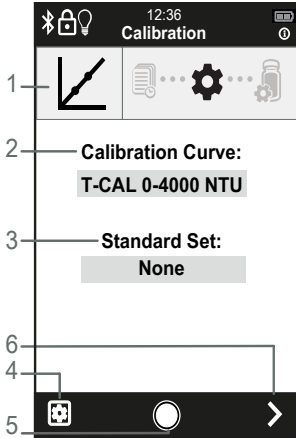

Description	Function
1 Application Bar	Breadcrumb to help the user through the process steps.
2 Calibration Curve	Specifies calibration type.
3 Standard Set	Unique identifier of standard set.
4 Settings Button	Used to change settings.
5 Home Button	Returns user to home screen.
6 Next Button	Progress to next screen.

4.5.2 Performing a Calibration

Please prepare the T-CAL[®] standards included in the scope of delivery before calibration. Make sure that the T-CAL[®] vials are free of stains, scratches or blemishes.

- T-CAL[®] standards for TB 350 IR: 20 / 800 / 4000 NTU
- T-CAL[®] standards for TB 350 WL: 20 / 800 / 2000 / 4000 NTU



- 1. Zero Adjustment:**
Sets zero standard.

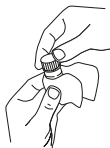

2. Prepare Vial:
Oil sample vial if necessary.



3. Insert Standard:
Insert standard value specified on screen.
User will insert series of various turbidity standards to complete calibration.



4. Modal:
Represents active process.



5. Log Summary:
Press Save Button to save log.
Press Cancel Button to return to beginning of calibration process.

4.5.3 Calibration Settings



Press the Settings Button to access the settings mode.

Icon	Description	Option	Function
	Cal Curve	T-CAL®	Selects prepared stabilized formazine standard at pre-defined concentrations
		User Formazin	Selects user prepared formazine standard at pre-defined concentrations
	Standard Set	Default	Used if no unique identifier is set.
		Unique	Unique identifier of standard set.
	Reminder ¹⁾	On	Reminds user that calibration is due. Option to force Calibration before additional measurements occur.
		Off	Default setting.
	Default Cal		Option to return to factory calibration setting.
	Post Verify	On	Requires user to perform a Verification after calibration is complete.
		Off	Default setting.



Cal Checker

On (Default)	During the calibration procedure, if an individual standard is out of tolerance, the user must correct the standard to proceed or cancel the calibration procedure. Feature prevents user from a calibration error due to an incorrect standard. The log screen will have a line item for Calibration Checker and it will show an "On" or "Enabled" state.
Off	During the calibration procedure, if an individual standard is out of tolerance, user will not be notified that a calibrator is out of Tintometers predefined range. The log screen will have a line item for Calibration Checker and it will show an "Off" or "Disabled" state.

¹⁾not TB350

4.6 Verification

4.6.1 Verification Overview

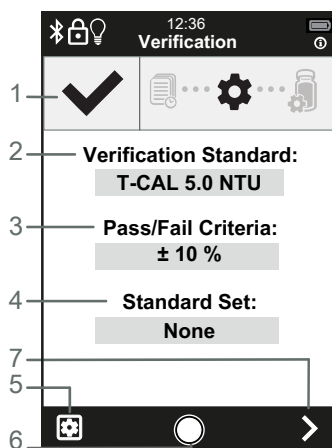

Description	Function
1 Application Bar	Breadcrumb to help the user through the process steps.
2 Verification Standard	Value of Standard to be measured.
3 Pass / Fail Criteria	Tolerance used for determining if a verification passes or fails.
4 Standard Set	Unique identifier of standard set.
5 Settings Button	Used to change settings.

Description	Function
1 Application Bar	Breadcrumb to help the user through the process steps.
6 Home Button	Returns user to home screen.
7 Next Button	Progress to next screen.

4.6.2 Performing a Verification

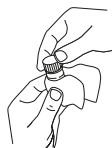

1. Prepare Vial

Oil sample vial if necessary.



3. Insert Standard

Insert standard value specified on screen.



4. Modal

Represents active process.



5. Log Summary

Press Save button to save log.

Press Cancel Button to return to beginning of Verification process.

4.6.3 Verification Settings



Press the Settings button to enter the settings mode.

Icon	Description	Option	Function
	Standard	T-CAL 5.0 NTU	Selects prepared stabilized formazin standard at 5.0 NTU concentration.
		User Prepared	Selects user prepared standard between 1 and 1000 NTU.



Pass/Fail criteria	$\pm 10\%$	Tolerance used for determining if a verification passes or fails.
	$\pm 5\%$	
	± 0.05 NTU	
	± 0.10 NTU	
	Custom	User entered value. Tolerance of $\pm 20\%$ or $\pm 0.05 - 0.2$ NTU allowed.



Reminder¹⁾	On	Reminds user that verification is due.
	Off	Default setting.

¹⁾ not TB350

4.7 Logs

4.7.1 Selecting a Log Type



Press the Log Type Button in the Action Area to access the Logs.

Application Bar:



Measurement Logs:

Displays all recorded measurements.



Calibration Logs:

Displays all calibration records.



Verification Logs:

Displays all verification records.

¹⁾

GLP Mode Logs:

Displays record of GLP mode being enabled or disabled.

¹⁾ not TB350

4.7.2 Retrieving a Log



1. Select log type

Displays the records of the type of log user would like to view.



2. Export Individual Logs

If a single record is selected, that log is exported in CSV format.
All details associated with log are exported.



3. Select Transmission Method

USB: Exports log to USB drive.



Bluetooth[®]¹⁾: Exports log to AquaLX mobile application.
Not available on TB 350.

Note: an external Lovibond[®] Bluetooth[®] dongle is required for connection to the USB-A port.

¹⁾ not TB 350

EN

4.8 Instrument Settings



Press the Settings Button to access the Settings Mode.

Icon	Description	Option	Function
	Security	Enable	Set up, verify, and change password.
		Disable	Default Setting.
	Power Settings	Screen Brightness	Adjust brightness of the screen.
		Backlight Sleep	Off 20 Seconds 30 Seconds 1 Minute* 5 Minutes
		System Shutoff	Off 1 Minute 2 Minutes 5 Minutes 15 Minutes*
			Note: If USB-C power cable is in use, System Shutoff is overridden to "Off" until instrument is unplugged, then will default back to selected option.

**Bluetooth¹⁾**

Enable

Enables Bluetooth® when hardware is present.

Disable

Default Setting.

**USB Shortcuts¹⁾**

Enable

If enabled, when a USB storage device is connected, the user is presented with a modal which presents an option for “transferring logs” or “backup/restore” settings. By selecting an option, the user is directed to the appropriate function.

Disable

Default Setting; users must access the “Logs” or “Backup/Restore” settings when USB storage device is connected.

**Language**

Select language.

**Date/Time**

Select time displayed and format.

**Backup/Restore**Backup All Settings¹⁾

Option to store settings to local SD Card or save to external USB drive.

Restore All Settings¹⁾

Recovers previously stored settings saved to local SD card or external USB drive.

Restore Factory Settings

Resets all settings to factory defaults. Saved logs are still available.

**Unit Type**

NTU	Select unit displayed.
FNU	Defines the unit type of the displayed measurement value.
mg.l Kaolin	NTU is Default setting.
mg.l PSL	
Degrees	
mNTU ¹⁾	
mFNU ¹⁾	
Custom ¹⁾	Allow user defined unit type and ability to set a factor based on NTU/FNU values.

**GLP¹⁾**

Enable	Establishes protocol for data integrity for laboratories following Good Laboratory Practices.
Disable	Default setting.

**Owner**

Contact details of instrument owner.

**Contact**

Contact information for Lovibond® offices.

**About**

About Lovibond®.

¹⁾ not TB 350

* Default Setting

5 Maintenance

5.1 Recommended maintenance schedule

Task	Do	Do not
1. Clean measurement chamber	1. Ensure the measurement chamber is clean and dry prior to measurement. Use a dry microfiber cloth to remove impurities.	1. Spray or pour any fluid directly into the measurement chamber.
2. Clean instrument display	2. Wipe touchscreen with a dry or slightly damp microfiber cloth.	2. Measure a sample that is not tightly capped.
Clean exterior housing	Clean the outer housing with a mild detergent solution or diluted alcohol.	
Sample Cell Storage & Care	Always rinse vials with turbidity-free water after use.	Use excessive silicone oil that has not been wiped from the vial. A single bead is all that is necessary.
	Fill vial with DI water. Cap vial to prevent formation of water spots.	Leave sample cells uncapped to air dry.
	Wipe outside of vial dry with a microfiber cloth.	Use any vial that has visible imperfections, including pits, scratches, or cracks.
Battery Replacement	It is suggested to remove batteries if instrument is stored for more than 30 days to prevent battery leakage.	Use unspecified type of battery.
Calibration	Calibrate as needed under the following conditions: <ol style="list-style-type: none"> 1. Verification failure. 2. Maintenance of optical or electronic systems are performed. 3. As required by regional regulatory authorities. 	Use expired standards.
	Carefully follow the instructions preparation and use of standards.	

Task	Do	Do not
Verification	Verify instrument performance under the following conditions: <ol style="list-style-type: none"> 1. After performing a calibration. 2. Per internal quality control procedures. 3. As required by regional regulatory authorities. 	Use expired standards.
	Carefully follow the instructions for preparation and use of standards.	
Connectors	Ensure connector plugs are in place when not in a laboratory environment.	Store instrument without connector plugs in place. Transport or support instrument via a connector cable.

**Warning!**

Improper handling of certain reagents can cause damage to your health. In any case follow the safety labels on the packing, the safety instructions of the package insert and available SDS. Protective measures specified there have to be followed exactly.

6 Troubleshooting

6.1 Error messages and what to do

Symptom	Possible Cause	Solution
Overrange	The turbidity of the sample is beyond the measuring range of the instrument.	<ul style="list-style-type: none"> • Dilute the sample • Verify calibration using a high-range standard.
Under range	The turbidity of the sample is below the detection limit of the instrument	<ul style="list-style-type: none"> • Repeat the stray light measurement (zero adjustment) as instructed ensuring the sample lid is closed. • Repeat the calibration after the stray light was determined.
Instrument does not turn on	Batteries are defective Batteries are not inserted correctly	<ul style="list-style-type: none"> • Replace batteries with a complete new set.
“Save” button for a function does not appear, so a log cannot be created.	Required information is missing	Ensure that the user initials and all other required fields are properly addressed.
Instrument will not take a measurement	Lid is not closed	Close the lid.
Low battery notification	Battery is below 20%	Replace or recharge batteries
Instrument settings cannot be accessed by user	Instrument security protocol is in place	Enter the password to unlock settings and calibration functions
Calibration Error	Sample vials were not cleaned prior to calibration	<ul style="list-style-type: none"> • Re-wash sample vials using the procedure in the manual. Store vials as prescribed in the manual. • Check expiration date of standard
Calibration Error	Calibration standards were ran in the wrong order	Repeat calibration with standards run from lowest to highest value.

Symptom	Possible Cause	Solution
Calibration Error	Calibration standards were not adequately mixed.	Mix standards as instructed immediately prior to performing the calibration.
Calibration Error	Calibration Standards prepared to wrong turbidity values	Repeat preparation of calibration standards, making sure dilutions are correct.
Verification Error	Verification falls outside the Error boundaries	<ul style="list-style-type: none"> • Mix the verification standard prior to verification. • Check pass/fail criteria to ensure the criteria is not tighter than the accuracy of the standard and adjust these criteria accordingly. • Check expiration date of standard

7 Accessories & Replacement parts

7.1 List of Accessories

Title		Part Number
Batteries (AA), set of 4	TB350 IR, TB350 WL	1950025
Brush, 11 cm length	TB350 IR, TB350 WL	380230
Cleaning cloth	TB350 IR, TB350 WL	197635
Cuvette stand for 6 round cuvettes Ø 24 mm	TB350 IR, TB350 WL	418951
Power supply TB series	TB350 IR, TB350 WL	19820-170
Rechargeable battery pack, Ni-MH	TB350 IR, TB350 WL	19820-011
Sample cuvettes with black lid, Height 55 mm, ø 24 mm, set of 12	TB350 IR, TB350 WL	197655
Set turbidity standards T-CAL (5, 20, 800, 2000, 4000 NTU)	TB350 WL	194152
Set turbidity standards T-CAL (5, 20, 800, 4000 NTU)	TB350 IR	194154
Silicon oil	TB350 IR, TB350 WL	194295
T-CAL®-Standard, 4000 NTU, 125 ml	TB350 IR, TB350 WL	48012912
T-CAL®-Standard, 4000 NTU, 500 ml	TB350 IR, TB350 WL	48012950
USB-C cable 1 m, USB-C to A	TB350 IR, TB350 WL	19820-081

7.2 Replacement Parts

Description	Part Number
Carrying Case	19820-130
Lid, sample chamber	19820-095
Cover, Battery compartment	19820-098
Plug, Elastomeric, IP67, I/O	19820-084
Insert for 4 AA batteries	19820-012

8 Specifications

Model	Model WM-040-1004 (IR) Model WM-040-1001 (WL)
Light Source	IR LED (860 nm) White LED
Regulatory Compliance	ISO 7027 EPA approved (alternative to US EPA 180.1)
Measuring Principle	Nephelometric (Multipath 90° BLAC)
Measuring Range	0.01 - 4000 NTU (FNU)
Resolution	Auto ranging: 0.01-9.99: 0.01 NTU ; 10.0-99.9: 0.1 NTU ; 100-4000: 1 NTU
Accuracy	± 1.8 % of reading + straylight
Repeatability	< 1 % or ± 0.01 NTU
Stray Light	< 0.014 NTU
Display Units	NTU, FNU, Degrees, mg/L Kaolin, mg/L PSL
Response Time	7 seconds
Reading Modes	Single, Signal Averaging, Fast-Settling
Calibration Options	Full-range calibration from 0 - 4000 NTU
Detector	Silicon Photodiode
Ratio Mode	Yes
Sample Required	10 mL (0.4 oz)
Display	Full-Colour Touchscreen
Display Size	55 x 95 mm (W x H)
Interfaces	<ul style="list-style-type: none"> • USB-A • USB-C
Data Logger	250 measurements, all calibrations, verifications and factory-restore actions
Data Transfer Format	.csv
Power Save Mode	Yes
Auto – OFF	Selectable

Power Supply	<ul style="list-style-type: none"> • 3 NiMH-battery pack (AA) • 4 batteries (AA) • Universal (90 - 240 VAC), via external power supply
Environmental Conditions	<p>Temperature: 0 - 50 °C (32 - 122 °F)</p> <p>Humidity: 0 - 90 % at 30 °C, noncondensing</p> <p>Humidity: 0 - 80 % at 40 °C, noncondensing</p> <p>Humidity: 0 - 70 % at 60 °C, noncondensing</p>
Protection Class	IP 67 (Instrument)
Compliance	<ul style="list-style-type: none"> • CE • CSA • FCC A • RoHS • TÜV • UL • WEE
Languages User Interface	<ul style="list-style-type: none"> • Chinese • Dutch • English • French • German • Japanese • Polish • Portuguese • Spanish • Turkish
Languages Quick Start Guide	<ul style="list-style-type: none"> • Chinese • Dutch • English • French • German • Italian • Portuguese • Russian • Spanish • Turkish

Languages Full User Manual	<ul style="list-style-type: none"> • Chinese • Dutch • English • French • German • Italian • Portuguese • Russian • Spanish • Turkish
Dimensions	155 x 83 x 225 mm
Weight	804 g (898 g with four AA alkaline batteries)
Weight with Packaging	(898 g with four AA alkaline batteries)

**Caution!**

Subject to technical modification!
To ensure maximum accuracy of test results, always use the reagent systems supplied by the instrument manufacturer.

8.1 Specifications - Mains adapter

Type	WR9QA2500USB52NMR6B
Design	Mains adapter plug, switching power supply
Input voltage, frequency	100 – 240 V \pm 10 %, 50 / 60 Hz \pm 5 %
Input current	0.3 A
Primary adapter	Europe, UK, Australia, USA
Protection class	II
Output voltage, frequency	5.2 V, DC
Max. output current	2.5 A
Output protection	Output shut down and auto restart
Environmental conditions	0 °C to 40 °C, with max. 95 % relative air humidity
Energy efficiency class	VI
Safety standard	EN 62368
EMC	EN 55032 FCC Part 15 Class A EN 55024
Dimensions [mm]	31.5 x 41 x 71 (without primary adapter)
Weight, with EU adapter	48 g (without primary adapter blades)

Type **WR9QA2500USB52NMR6B**

Approval, EMC CE, FCC

Permitted altitude meters 5000 m

Pollution level 2

**Caution!**

Subject to technical modification!
To ensure maximum accuracy of test results, always use the reagent systems supplied by the instrument manufacturer.

EN

9 Appendix

9.1 List of Trademarks

Lovibond®, Tintometer® and T-CAL® are registered trademarks of the Tintometer group of companies. All translations and transliterations of Lovibond® and Tintometer® are asserted as trademarks of The Tintometer® Group.

The Bluetooth® mark, figure mark and combination mark are trademarks owned by the Bluetooth SIG and any use by the Tintometer® Group is under license.

Inhaltsverzeichnis

DE

	Seite
1 Einleitung	44
1.1 Allgemeine Informationen	44
1.1.1 Anleitung vor Gebrauch lesen	44
1.1.2 Zweck des Produkts	44
1.1.3 Bestimmungsgemäße Verwendung	44
1.1.4 Voraussetzungen für einen sicheren Gebrauch	44
1.1.5 Anleitung aufbewahren	45
1.1.6 Benutzerqualifikation	45
1.1.7 Umgang mit gefährlichen Chemikalien	45
1.1.8 Entsorgungshinweise	46
1.2 Liste aller verwendeten Zeichen im Dokument	46
1.3 Abkürzungen	46
2 Produktübersicht	47
2.1 Zertifizierung	47
2.2 Ausstattung	48
2.3 Beschreibung des Produktes	48
2.4 Geräteansicht	49
3 Inbetriebnahme	50
3.1 Betriebsumgebung	50
3.2 Lieferumfang	50
3.3 Einsetzen und Auswechseln der Batterien	51
4 Arbeitsweise	53
4.1 Erstmalige Inbetriebnahme	53
4.2 Allgemeine Funktionsprinzipien	54
4.3 Liste der Bedienelemente und deren Funktion	55
4.3.1 Display Übersicht	55
4.3.2 Statuszeile	56
4.3.3 Startseite	58
4.4 Messung	59
4.4.1 Anzeige der Messergebnisse	59
4.4.2 Durchführen einer Messung	60
4.4.3 Tipps zur Messung	61
4.4.4 Messeinstellungen	62
4.5 Kalibrierung	63
4.5.1 Anzeige der Kalibrierung	63
4.5.2 Durchführung einer Kalibrierung	63
4.5.3 Kalibrierungseinstellungen	64

	Seite
4.6 Verifikation	65
4.6.1 Anzeige der Verifikation	65
4.6.2 Durchführen einer Verifizierung	66
4.6.3 Verifikationseinstellungen	67
4.7 Protokolle	67
4.7.1 Auswahl einer Protokollart	67
4.7.2 Abrufen eines Protokolls	68
4.8 Geräteeinstellungen	68
5 Wartung	72
5.1 Empfohlener Wartungsplan	72
6 Fehlerbehebung	74
6.1 Fehlermeldungen und was zu tun ist	74
7 Zubehör & Ersatzteile	76
7.1 Zubehörliste	76
7.2 Ersatzteile	76
8 Spezifikationen	77
8.1 Spezifikationen - Netzadapter	79
9 Appendix	81
9.1 Hinweis zu Copyright und Warenzeichen	81

1 Einleitung

1.1 Allgemeine Informationen

1.1.1 Anleitung vor Gebrauch lesen

Diese Gebrauchsanleitung enthält wichtige Informationen zur sicheren Handhabung des Produkts. Lesen Sie diese Gebrauchsanleitung sorgfältig durch und machen Sie sich mit dem Produkt vertraut, bevor Sie damit arbeiten.

1.1.2 Zweck des Produkts

Das tragbare Trübungsmessgerät der TB-Serie wurde entwickelt, um wässrige Proben zu analysieren, die in Glasküvetten gesammelt und dann verschlossen werden. Die Küvette wird mit einer sorgfältigen Technik für die Messung vorbereitet, um Störungen durch Staub und Kratzer zu minimieren. Nach der Vorbereitung wird die Küvette zur Messung in das Instrument gestellt.

Das Instrument kann im Labor oder bei Aussen-/Feldanwendung verwendet werden, um Messungen an Proben unmittelbar nach Probennahme durchzuführen.

Der Transport dieses Trübungsmessgeräts sollte mit Vorsicht erfolgen. Wenn das Gerät ins Feld mitgenommen wird, sollte der Tragekoffer verwendet werden. Wenn das Gerät für behördliche Anwendungen verwendet wird, ist es ratsam, sich mit den örtlichen Behörden in Verbindung zu setzen, um sicherzustellen, dass das richtige Gerätemodell ausgewählt wird.

1.1.3 Bestimmungsgemäße Verwendung

Die Haftung und Gewährleistung des Herstellers für Schäden und Folgeschäden erlischt bei unsachgemäßer Verwendung, wie Missachtung dieser Gebrauchsanleitung, Einsatz von nicht ausreichend qualifiziertem Fachpersonal oder nicht autorisierten Änderungen am Produkt.

Der Hersteller haftet nicht für Kosten oder Schäden, die dem Benutzer oder Dritten durch die Verwendung dieses Produkts entstehen.

Der Hersteller übernimmt keine Haftung für Druckfehler.

1.1.4 Voraussetzungen für einen sicheren Gebrauch

Beachten Sie die folgenden Punkte für einen sicheren Gebrauch des Gerätes:

- Wenn das Gerät in einer vom Hersteller nicht festgelegten Weise benutzt wird, kann der vom Gerät unterstützte Schutz beeinträchtigt sein.
- Das Produkt darf nur gemäß der oben angegebenen autorisierten Verwendung benutzt werden.
- Das Produkt darf nur von den in dieser Gebrauchsanleitung genannten Energiequellen mit Strom versorgt werden.
- Das Produkt darf nur unter den in dieser Gebrauchsanleitung genannten Umgebungsbedingungen eingesetzt werden.
- Das Produkt darf nicht geöffnet oder verändert werden.

Das Produkt darf nicht in Gebrauch genommen werden, wenn:

- es sichtbar beschädigt ist (z. B. nach dem Transport)
- es über einen längeren Zeitraum unter ungünstigen Bedingungen gelagert wurde (Lagerbedingungen; siehe Kapitel "Spezifikationen")

Voraussetzungen für einen sicheren Gebrauch des Steckernetzteil

Beachten Sie die folgenden Punkte für einen sicheren Gebrauch:

- Vor Inbetriebnahme auf sichtbare Beschädigung prüfen. Bei Beschädigung nicht in Betrieb nehmen.
- Nur in trockenen Räumen verwenden.
- Nur mit trockenen Händen handhaben.
- Es dürfen nur die vom Hersteller empfohlenen Netzteile verwendet werden.
- Das Produkt darf nicht geöffnet oder verändert werden.
- Für die Stromversorgung des Geräts darf nur das vom Hersteller empfohlene USB-C-Kabel verwendet werden.

DE

1.1.5 Anleitung aufbewahren

Die Gebrauchsanleitung muss in der Nähe des Produktes aufbewahrt werden, damit die benötigten Informationen immer verfügbar sind.

1.1.6 Benutzerqualifikation

Das Bedienpersonal muss in der Lage sein, die Sicherheitsetiketten und Sicherheitshinweise auf den Verpackungen und Beilagen der Produkte zu verstehen und korrekt umzusetzen.

Der Benutzer muss fähig und in der Lage sein, diese Gebrauchsanleitung zu lesen und zu verstehen, um sich mit der Handhabung vertraut zu machen und einen sicheren Umgang zu gewährleisten.

1.1.7 Umgang mit gefährlichen Chemikalien

Bei Verwendung dieses Produkts können chemische und / oder biologische Gefahren bestehen. Befolgen Sie alle geltenden Gesetze, Vorschriften und Protokolle, wenn Sie dieses Produkts benutzen.

Bei der Entwicklung von Produkten achtet Lovibond® besonders auf die Sicherheit. Einige Gefahren durch gefährliche Substanzen können nicht vermieden werden. Wenn selbst erstellte Tests oder Lösungen verwendet werden, liegt die Verantwortung für alle durch diese Tests oder Lösungen verursachten Risiken beim Benutzer (persönliche Verantwortung).

Beachten Sie zu Ihrem eigenen Schutz, dass bei Trübungsstandards größer 5 NTU das Tragen von Schutzhandschuhen oder Schutzbrille empfohlen wird. Beachten Sie das jeweilige Sicherheitsdatenblatt.

Die Sicherheitsdatenblätter der Chemikalien enthalten alle Anweisungen zur sicheren Handhabung, zu auftretenden Gefahren, vorbeugenden Maßnahmen und Maßnahmen in Gefahrensituationen.

1.1.8 Entsorgungshinweise

Entsorgen Sie die Batterien und elektrischen Geräte in einer geeigneten Einrichtung gemäß den örtlichen gesetzlichen Bestimmungen.

Es ist illegal, die Batterien mit dem Hausmüll zu entsorgen.

Innerhalb der Europäischen Union werden die Batterien am Ende der Lebensdauer des Gerätes in einer spezialisierten Recycling-Sammelstelle entsorgt.



Geräte, die mit diesem Symbol gekennzeichnet sind, dürfen nicht über den normalen Hausmüll entsorgt werden.

DE

1.2 Liste aller verwendeten Zeichen im Dokument

Die folgenden Symbole werden in diesem Handbuch verwendet, um Abschnitte zu kennzeichnen, die besondere Aufmerksamkeit erfordern:



Gefahr!

Es besteht eine Gefahr, die zum Tod oder zu schweren Verletzungen führt, wenn sie nicht vermieden wird!



Warnung!

Ein unsachgemäßer Umgang mit bestimmten Reagenzien kann Ihre Gesundheit schädigen. Befolgen Sie in jedem Fall die Angaben auf den Sicherheitsetiketten der Verpackung, die Sicherheitshinweise der Packungsbeilage und das verfügbare Sicherheitsdatenblatt. Dort festgelegte Schutzmaßnahmen müssen genau befolgt werden.



Vorsicht!

Es besteht eine Gefahr, die zu leichten oder mittelschweren Verletzungen führen kann.

1.3 Abkürzungen

Abkürzungen	Definition
NTU	Nephelometric Turbidity Unit
FNU	Formazin Nephelometric Units
mg/l	Milligramm pro Liter

2 Produktübersicht

2.1 Zertifizierung

EMV leitungsgebundene und abgestrahlte Störungen	CISPR 11 (Grenzwerte der Klasse A)	CE- Kennzeichnung
EMC Störsicherheit	EN 61326-1 (Industrielle Grenzwerte)	CE- Kennzeichnung
Sicherheit	EN 61010-1	TÜV Sicherheitszeichen
FCC	FCC Klasse A	FCC- Kennzeichnung

Hinweis FCC-Klasse A

Dieses Gerät entspricht Teil 15 der FCC-Bestimmungen. Der Betrieb unterliegt den folgenden zwei Bedingungen:

- Dieses Gerät darf keine schädlichen Störungen verursachen.
- Dieses Gerät muss alle empfangenen Störungen akzeptieren, einschließlich Störungen, die einen unerwünschten Betrieb verursachen können.

Hinweis: Dieses Gerät wurde getestet und entspricht den Grenzwerten für ein digitales Gerät der Klasse A gemäß Teil 15 der FCC-Vorschriften. Diese Grenzwerte sind so ausgelegt, dass sie einen angemessenen Schutz gegen schädliche Störungen bieten, wenn das Gerät in einer kommerziellen Umgebung betrieben wird. Dieses Gerät erzeugt und verwendet Hochfrequenzenergie und kann diese ausstrahlen. Wenn es nicht gemäß der Bedienungsanleitung installiert und verwendet wird, kann es schädliche Störungen des Funkverkehrs verursachen. Der Betrieb dieses Geräts in einem Wohngebiet wird wahrscheinlich schädliche Störungen verursachen, in diesem Fall muss der Benutzer die Störungen auf eigene Kosten beheben.

Abgeschirmte Kabel



Die Verbindungen zwischen dem System und seinen Peripheriegeräten müssen mit abgeschirmten Kabeln hergestellt werden, um die Einhaltung der FCC-Grenzwerte für Funkfrequenzen zu gewährleisten.

Vorsicht!

Modifikationen



Jegliche Änderungen an diesem Gerät, die nicht von Tintometer genehmigt wurden, können dazu führen, dass die dem Benutzer von der FCC erteilte Genehmigung zum Betrieb dieses Geräts erlischt.

Vorsicht!

DE

DOC Klasse A Hinweis - Avis DOC, Klasse A

Dieses digitale Gerät der Klasse A erfüllt alle Anforderungen der Canadian Interference-Causing Equipment Regulations.

2.2 Ausstattung

Laborgenauigkeit trifft Tragbarkeit

Die Lovibond® TB-Serie vereinfacht die Trübungsmessung. Mit ihrer neuen Technologie bietet sie ein Höchstmaß an Genauigkeit sowie gesteigerte Effizienz im Betriebsablauf und bei der Anwendung geltender Vorschriften.

- Touchscreen-Oberfläche für einfache Bedienung
- Bildgeschützte Anweisungen, um den Benutzer durch die Prozessschritte zu führen und Fehler zu vermeiden.
- Einfache Datenverwaltungsprotokolle zur Gewährleistung der Datenintegrität

2.3 Beschreibung des Produktes

Die Trübung ist ein optischer Eindruck einer Probe, die dazu führt, dass Lichtstrahlen gestreut und absorbiert werden, anstatt in geraden Linien durch eine flüssige Probe durchgeleitet zu werden. In Wasser wird Trübung oft durch das Vorhandensein von Stoffen wie Ton, Schlack, fein verteiltem organischem Material, Plankton, anderen mikroskopischen Organismen, organischen Säuren und Pigmenten verursacht. Die Trübungsmessung wird zur Überwachung von Prozessen eingesetzt, bei denen die Konzentration von Partikeln in Lösungen entfernt oder verändert wird, wie z. B. bei der Herstellung von Trinkwasser. Diese Lovibond® Trübungsmessgeräte sind so konzipiert, dass sie hohe Genauigkeit und hohe Empfindlichkeit, die von einem Labortrübungsmessgerät erwartet werden, mit Tragbarkeit verbinden.

2.4 Geräteansicht

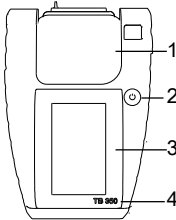
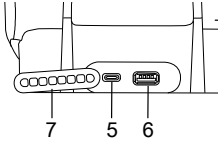
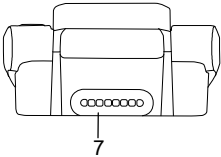
Position	Beschreibung	Funktion
	1. Messschachtdeckel	Wenn er angehoben wird, kann der Benutzer die Probenküvette für eine Messung in das Gerät einsetzen.
	2. Ein/Aus-Taste	Schaltet das Gerät EIN und AUS.
	3. Touchscreen	Zeigt die Benutzeroberfläche des Geräts an.
	4. Modellbezeichnung	Bezeichnet die Geräteversion.
	5. USB-C-Anschluss	Versorgt das Gerät mit Strom aus einer externen Quelle oder lädt den Zusatzakku auf (falls installiert).
	6. USB-A-Anschluss	Unterstützt externe USB-A-Geräte für Funktionen wie Datenübertragung oder Backups.
	7. Dichtung	Dient zur Abdeckung der USB-Anschlüsse, wenn die Anschlüsse nicht verwendet werden.

DE

3 Inbetriebnahme

3.1 Betriebsumgebung

Das Gerät kann in jeder Innen- oder Außenumgebung verwendet werden, die für einen Bediener als sicher gilt, um die Analyse durchzuführen.

Mit dem Gerät können wässrige Proben von 0 bis 70 °C gemessen werden.

Das Gerät sollte bei der Durchführung einer Messung waagrecht $\pm 15^\circ$ aufgestellt werden.

Das Gerät sollte auf eine ebene Fläche gestellt werden, um die beste Messleistung zu erzielen.

3.2 Lieferumfang

Überprüfen Sie sorgfältig alle Teile, um sicherzustellen, dass jedes Teil der untenstehenden Liste vorhanden ist und keine sichtbaren Schäden während des Transports aufgetreten sind. Sollte etwas beschädigt sein oder fehlen, wenden Sie sich bitte sofort an Ihren lokalen Händler.

TB	350 IR	350 WL
Instrument	X	X
Silikon Öl, 15 ml	X	X
Mikrofasertuch	X	X
2 x Probenküvetten	X	X
Schraubendreher	X	X
Bürste	X	X
Koffer mit Einsatz	X	X
Kurzanleitung	X	X
Konformitätserklärung	X	X
Garantieerklärung	X	X
4 x AA Batterien	X	X
Wiederaufladbares Akkupack		
USB-C Kabel		
AC-Netzgerät		
Adapter für US, UK und EU-Stecker		
T-CAL® Standard, 5 NTU	X	X
T-CAL® Standard, 20 NTU	X	X
T-CAL® Standard, 800 NTU	X	X
T-CAL® Standard, 2000 NTU		X
T-CAL® Standard, 4000 NTU	X	X

3.3 Einsetzen und Auswechseln der Batterien

Bei Verwendung von Batterien

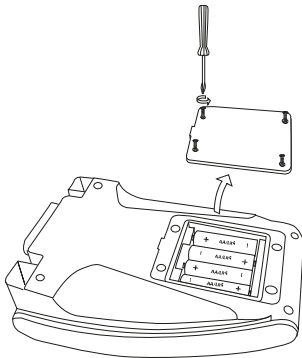

DE

Schritt	Beschreibung
1	Verwenden Sie einen Schraubendreher, um die vier Schrauben auf der Rückseite des Geräts zu entfernen und den Batteriefachdeckel abzunehmen.
2	Legen Sie vier AA-Batterien in der richtigen Ausrichtung ein.
3	Bringen Sie den Batteriefachdeckel wieder am Gerät an.



- Nur den zugelassenen Typ: Alkali-Mangan Batterie, LR6, mit 1,5V Spannung verwenden.
- Leere Batterien möglichst bald aus dem Gerät entnehmen.
- Wenn das Gerät längere Zeit nicht benutzt wird, die Batterien aus dem Gerät entnehmen.

Vorsicht!

Bei der Verwendung von wiederaufladbaren Akku Packs

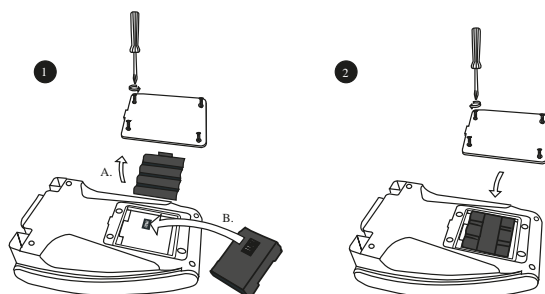

Schritt	Beschreibung
1	Entfernen Sie mit einem Schraubendreher die vier Schrauben auf der Rückseite des Geräts, nehmen Sie die Abdeckung und das Batteriefach ab.
2	Legen Sie den wiederaufladbaren Akku in der richtigen Ausrichtung ein.
3	Bringen Sie die Blende wieder am Gerät an.



Warnung!

Das wiederaufladbare Akkupacks (19820-011) ist nur mit Geräten mit der Seriennummer 23041000 und höher kompatibel.

Die Verwendung des Akkupacks für Geräte mit Seriennummern vor 23041000 kann zu einer Überhitzung des Geräts während des Ladevorgangs führen.

Diese Überhitzung kann zu falschen Messwerten und einer Beschädigung des Geräts führen und muss daher vermieden werden.

Für Geräte mit Seriennummern vor 23041000 wenden Sie sich bitte an Lovibond®, um Einzelheiten zur Verwendung dieses Zubehörs zu erfahren.

4 Arbeitsweise

4.1 Erstmalige Inbetriebnahme



1. Willkommensbildschirm

Startbildschirm, den der Benutzer beim ersten Einschalten sieht.
Drücken Sie die Taste >



2. Sprache wählen

Wählen Sie die gewünschte Sprache aus.
Drücken Sie die Taste >



3. Datum und Uhrzeit einstellen

Zwischen 12- und 24-Stunden-Format wählen.
Ändern Sie die Werte mit den Auf- und Abwärtspfeilen.
Drücken Sie die Taste >



4. Passwort

Legen Sie ein vom Benutzer gewähltes Passwort fest, um Sicherheitsfunktionen auf dem Gerät zu implementieren.
Drücken Sie die Speichertaste.
Wenn kein Passwort gewünscht ist, wählen Sie "Überspringen".
Drücken Sie die Taste >



5. Standard-Einheiten

Wählen Sie die gewünschte Einheit aus.
Drücken Sie die Taste >



6. Kontaktinformationen

Informationen zum Gerätebesitzer eingeben.
Speichern-Taste drücken.
Wenn keine Details gewünscht sind, wählen Sie "Überspringen".
Drücken Sie die Taste >



7. Übersichtsbildschirm

Überprüfung der Anfangseinstellungen.
Drücken Sie <, um die Einstellung zu ändern, bevor Sie fortfahren.
Drücken Sie >, um mit dem Startbildschirm fortzufahren.
Der Benutzer kann eine Aufgabe auswählen, die mit dem Gerät durchgeführt werden soll.

4.2 Allgemeine Funktionsprinzipien

Die Konstruktionen der tragbaren Trübungsmessgeräte der TB-Serie werden in ihre jeweiligen funktionellen Komponenten unterteilt, die im Detail besprochen werden. Dazu gehören die Lichtquelle, die 90-Grad-Streulichtfalle, der Streulichtdetektor, die Probenküvette und die Art und Weise, wie diese Hauptbestandteile zusammenarbeiten, um das Trübungsergebn zu liefern.

DE

Der vereinfachte optische Aufbau für die tragbaren Trübungsmessgeräte der TB-Serie.

Diese Abbildung zeigt den Weg des einfallenden Lichtes und die Ansicht des 90°-Streulichtdetektors.

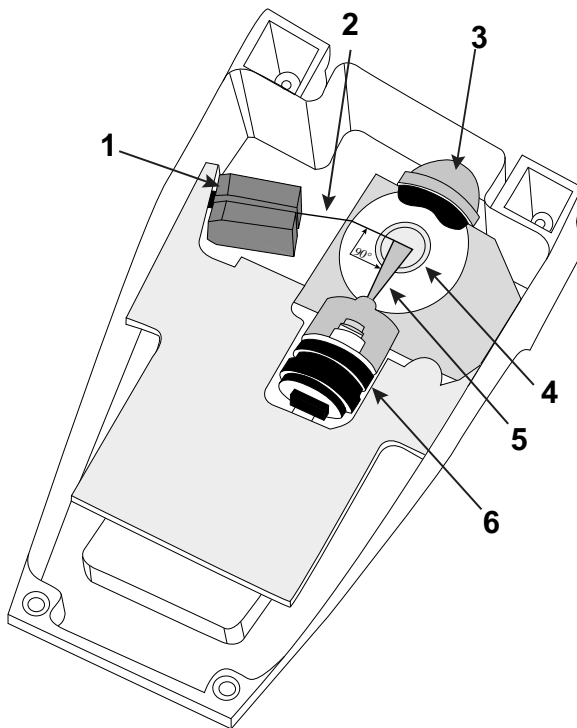



- 1 Lichtquelle (LED und Optik)
- 2 einfallendes Licht
- 3 90° Lichtfalle für Streulicht
- 4 Probenküvette
- 5 Streulicht (10°-20° Detektoransicht)
- 6 Streulichtdetektor und Optik



4.3 Liste der Bedienelemente und deren Funktion

4.3.1 Display Übersicht



















Beschreibung	Funktion
1 Statuszeile	Zeigt die universellen Symbole und Beschriftungen an, einschließlich Zeit, Bluetooth®, USB, Sicherheit, Lichtquelle und Stromversorgung.
2 Aktionsfläche	Bereich, der Anwendungsschritte und Interaktion anzeigt.
3 Home-Taste	Dient in erster Linie zur Navigation, zum Starten oder Speichern oder Verwerfen von Aktionen und zur Rückkehr auf die Startseite.



Symbol	Beschreibung
	Messmodus
	Kalibrierungsmodus
	Verifikationsmodus

Symbol	Beschreibung
	Datenprotokolle
	Bluetooth-Verbindung zum PTV-Prozessstrübungsmessgerät (nicht verfügbar für TB 350)
	Geräteeinstellungen

4.3.2 Statuszeile

Symbol	Beschreibung	Funktion
	Anwendung Bezeichnung	Titel der Anwendung, die der Benutzer gerade verwendet.
	Zeit	Die Zeit wird vom Benutzer bei der Ersteinrichtung oder durch Zugriff auf die Geräteeinstellungen eingestellt. Das 12-Stunden- oder 24-Stunden-Format ist verfügbar.
	USB	Wird angezeigt wenn das USB-Modul an das Gerät angeschlossen ist.
	Bluetooth Symbol - einfach ²⁾	Wenn angezeigt, ist Bluetooth® eingeschaltet.
	Bluetooth Symbol – mit Pfeilen ²⁾	Wenn angezeigt, ist Bluetooth® eingeschaltet und kommuniziert aktiv mit einem PTV oder einer AquaLX-App.
	Rote Lichtquelle - ausgefüllt	Instrument zeigt eine rote LED-Lichtquelle; Licht wird zur Messung eingeschaltet.
	Rote Lichtquelle – Umriss	Instrument zeigt eine rote LED-Lichtquelle; Messung nicht aktive.
	Weißer Lichtquelle - ausgefüllt	Instrument zeigt eine weiße LED-Lichtquelle; Licht wird zur Messung eingeschaltet.







Symbol	Beschreibung	Funktion
	Weiß e Lichtquelle – Umriss	Instrument zeigt eine weiße LED-Lichtquelle; Messung nicht aktive.
	Infrarotlichtquelle – an	Instrument zeigt eine Infrarot-LED-Lichtquelle; Licht wird zur Messung eingeschaltet.
	Infrarotlichtquelle – aus	Instrument zeigt eine Infrarot-LED-Lichtquelle; Messung nicht aktive.
	Laserlichtquelle – ausgefüllt ¹⁾	Instrument zeigt eine Laser-LED-Lichtquelle; Licht wird zur Messung eingeschaltet.
	Laserlichtquelle – Umriss ¹⁾	Instrument zeigt eine Laser-LED-Lichtquelle; Messung nicht aktive.
	AC-Akkuladung	Akku wird geladen.
	AC-Netzsymbol	Zeigt an, dass das Gerät über mit Strom versorgt wird.
	Batterieleistung – Grün	Zeigt an, dass die Lebensdauer der Batterie noch 100 % beträgt.
	Batterieleistung – Gelb	Zeigt an, dass noch 75 % der Batterielaufzeit übrig sind.
	Batterieleistung – Orange	Zeigt an, dass noch 50 % der Batterielaufzeit übrig sind.





Symbol	Beschreibung	Funktion
	Batterieleistung - Rot	Zeigt an, dass noch 25 % der Batterielaufzeit übrig sind.
	Messschachtdeckel geöffnet	Zeigt an, wenn der Messschacht geöffnet ist.
	Messschachtdeckel geschlossen	Zeigt an, wenn der Messschacht geschlossen ist.

¹⁾ nur TB 600

²⁾ nicht TB 350

4.3.3 Startseite

Symbol	Beschreibung	Funktion
	Home-Taste	Bringt den Benutzer zum Startbildschirm zurück.
	Home-Taste - gesperrt	Die Sicherheitsfunktion ist aktiv; das Passwort wurde aktiviert und ist erforderlich, um bestimmte Funktionen auszuführen.
	Home-Taste - Entsperrt	Die Sicherheitsfunktion ist inaktiv; es sind keine Funktionen für den Benutzer gesperrt.
	Speichern-Taste	Speichert den im aktiven Bereich angezeigten Inhalt.
	Taste Einstellungen	Öffnet das Einstellungsmenü einer Anwendung.
	Export Taste	Exportiert die im aktiven Bereich angezeigten Protokolle.
	Taste Messung	Startet oder beginnt oder leitet eine Messung ein.

Symbol	Beschreibung	Funktion
	Taste Messung – mit Bluetooth ²⁾	Nimmt eine Messung vor, während das Gerät mit einer PTV-Einheit verbunden ist.
	Bluetooth [®] Aktualisieren-Taste ²⁾	Aktualisiert die Liste der verfügbaren PTV-Einheiten in der Nähe des Geräts.
	Abbrechen-Taste	Bietet die Möglichkeit, die aktuelle Aktivität im aktiven Bereich abzubrechen.
	Pfeil rechts	Weiterschalten zum nächsten Schritt innerhalb eines Prozesses.
	Pfeil links	Rückkehr zu einem vorherigen Schritt innerhalb eines Prozesses.

²⁾ nicht TB350

4.4 Messung

4.4.1 Anzeige der Messergebnisse

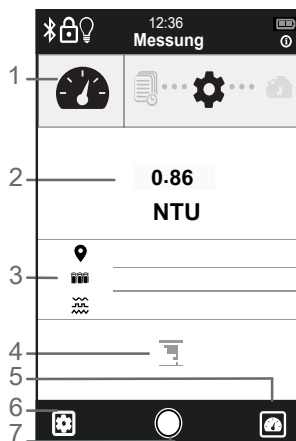

Beschreibung	Funktion
1 Anwendungsleiste	Navigationspfad, um den Benutzer durch die Prozessschritte zu führen.

Beschreibung	Funktion
2 Messwert	Anzeige des Messergebnis mit Einheit.
3 Einstellungen	Die für die Messung geltenden Einstellungen werden angezeigt.
4 Taste "Protokoll"	Erzeugt beim Drücken ein Protokoll.
5 Taste "Messung"	Startet oder beginnt oder leitet eine Messung ein, wenn sie gedrückt wird.
6 Taste "Einstellungen"	Dient zum Ändern von Einstellungen.
7 Taste "Home"	Bringt den Benutzer zum Startbildschirm zurück.

DE

4.4.2 Durchführen einer Messung

Bitte bereiten Sie die im Lieferumfang enthaltenen Probenküvetten vor der Messung vor. Stellen Sie sicher, dass die Probenküvetten frei von Flecken, Kratzern oder Unreinheiten sind.

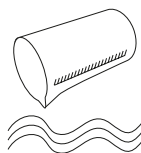

1. Probe sammeln:

Stellen Sie sicher, dass die Probe gut durchgemischt ist. Die Glaswaren sollten frei von Flecken, Kratzern oder anderen Verunreinigungen sein. Spülen Sie das Sammelgefäß vor der Probenentnahme mindestens zweimal mit der Probe aus.



2. Küvette vorbereiten:

Trocknen Sie das Äußere des Probengefäßes mit einem fusselfreien Tuch ab. Verwenden Sie Silikonöl, um Streulichtreflexionen zu minimieren.



3. Küvette in das Gerät einsetzen:

Stellen Sie sicher, dass die Probe blasenfrei ist. Durch langsames Umschwenken mischen. Nicht schütteln!

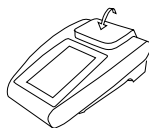

4. Deckel schließen:

Ohne geschlossenen Deckel ist keine Messung zulässig.



5. Einstellungen prüfen:

Stellen Sie sicher, dass die Messeinstellungen korrekt sind. Die Einstellungen für die Messung können nicht mehr geändert werden, nachdem die Messung erfolgt ist.



6. Drücken Sie die Messtaste:
Startet die Messung.



7. Datenprotokolle:
Wählen Sie "Datenprotokolle", um die Messung zu speichern.



8. Messung speichern:
Falls gewünscht, drücken Sie die Taste Speichern, um ein Messprotokoll zu erstellen.



9. Pause:
Hält im "kontinuierlichen" Messmodus die Messung an.



- Keine Gegenstände in den Messschacht bringen, außer die für die Messungen vorgesehenen Küvetten.
- Keine Flüssigkeiten in den Schacht bringen.

Warnung!

4.4.3 Tipps zur Messung

Indizieren einer Küvette: Benutzen Sie eine Küvette, die mit Wasser gefüllt ist, das durch einen 0,2 µm-Filter gefiltert wurde.

- Drücken Sie die Messtaste.
- Drehen Sie die Probe. Während Sie die Küvette drehen, identifizieren Sie den niedrigsten Messwert.
- Wenn die Position bestimmt ist, stoppen Sie die Messung. Markieren Sie die Küvette.
- Bevor Sie mit weiteren Messungen fortfahren, vergewissern Sie sich, dass der Messmodus ggf. aktualisiert wurde.
- Das Indizieren einer Küvette wird empfohlen, wenn ein auffälliger Kratzer oder eine Vertiefung in der Glasware vorhanden ist.

Verwendung von Silikonöl

- Achten Sie darauf, die Küvette nur am oberen Drittel anzufassen.
- Wischen Sie die Küvette mit dem mitgelieferten Reinigungstuch ab, um Wasser, Staub und Fingerabdrücke zu entfernen.
- Ölen Sie die Außenseite der Küvette mit Silikonöl.
 - Geben Sie einen sehr dünnen Streifen Silikonöl auf die Seite des Fläschchens. Verteilen Sie das Öl gleichmäßig über die unteren 2/3 des Fläschchens.
 - Wischen Sie das Silikonöl durch Drehen der Küvette in einem sauberen, staubfreien Tuch ab.
- Die Messungen von Wasserproben mit niedrigen Trübungswerten verlangen eine sehr gute Technik. Deshalb wird das Ölen der Küvetten empfohlen, wenn Proben mit einer zu erwartenden Trübung von unter 0,5 NTU gemessen werden.

Proben, die überschüssige Blasen enthalten

- Lassen Sie die Probe für mindestens fünf Minuten stehen.
- Probe zwei- bis dreimal vorsichtig umdrehen, um die Trübung zu resuspendieren.
- Setzen Sie die Küvette in das Gerät ein und verfahren Sie wie angewiesen.

Sonstige Hinweise

- Die Verwendung von Ultraschallbädern wird nicht empfohlen. Ultraschall kann die Partikelverteilung verändern.
- Verwenden Sie den Schnelleinstellungsmodus für Proben, die hohe Konzentrationen von Sanden oder Partikeln mit hoher Dichte aufweisen.

DE

4.4.4 Messeinstellungen

Drücken Sie die Taste "Einstellungen", um den Modus "Messeinstellungen" aufzurufen.

Symbol	Beschreibung	Option	Funktion
	Modus	Single	Drücken um einen Test auszulösen.
		Kontinuierlich ¹⁾	Die Messung wird alle X Sekunden aktualisiert, bis sie gestoppt wird.
		Fast Settling	Empfohlen für Proben mit schnellem Absetzverhalten.
	Ort	Standard-einstellung	Wird verwendet, wenn keine benutzerdefinierte ID eingestellt ist.
		Benutzerdefiniert	Benutzerdefinierte Beschreibung des Messortes und der Messgrenzen.
	Signal-durchschnitt	an	Wenn eingeschaltet, können bis zu 255 Messungen durchgeführt werden. Die Funktion sollte verwendet werden, wenn die Messungen instabil sind.
		aus	deaktiviert
	Proben-ID	Standard-einstellung	Wird verwendet, wenn keine benutzerdefinierte ID eingestellt ist.
		Benutzerdefiniert	Eindeutiger Bezeichnung der Probe; vom Benutzer wählbar.

¹⁾ nicht TB350

4.5 Kalibrierung

4.5.1 Anzeige der Kalibrierung

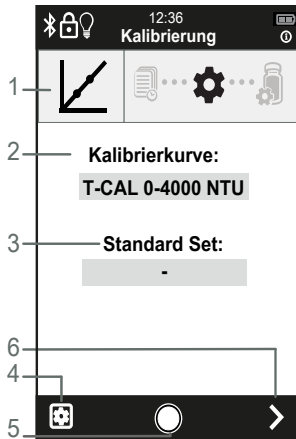

Beschreibung	Funktion
1 Anwendungsleiste	Navigationspfad, um den Benutzer durch die Prozessschritte zu führen.
2 Kalibrierkurve	Gibt den Kalibriertyp an.
3 Standard Set	Anzeige des zu verwendenden Standardsatzes.
4 Taste "Einstellungen"	Zum Ändern von Einstellungen.
5 Taste "Home"	Bringt den Benutzer zum Startbildschirm zurück.
6 Taste "Weiter"	Weiter zur nächsten Anzeige.

4.5.2 Durchführung einer Kalibrierung

Bitte bereiten Sie die im Lieferumfang enthaltenen T-CAL®-Standards vor der Kalibrierung vor. Achten Sie darauf, dass die T-CAL®-Küvetten frei von Flecken, Kratzern oder Verunreinigungen sind.

- T-CAL®-Standards für TB 350 IR: 20 / 800 / 4000 NTU
- T-CAL®-Standards für TB 350 WL: 20 / 800 / 2000 / 4000 NTU



1. Nullabgleich:

Führt einen Nullabgleich durch.

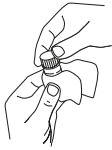

2. Küvette vorbereiten:

Küvette bei Bedarf ölen.

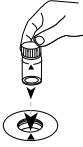

3. Standard in das Gerät einsetzen:

Den auf dem Bildschirm angegebenen Standard einsetzen. Der Benutzer setzt eine Reihe verschiedener Trübungsstandards ein, um die Kalibrierung durchzuführen.



4. Aktion:

Steht für einen aktiven Prozess.



5. Protokoll-Zusammenfassung:

Drücken Sie die Taste "Speichern", um das Protokoll zu speichern.
Drücken Sie die Taste "Abbrechen", um zum Anfang des Kalibrierungsvorgangs zurückzukehren.

4.5.3 Kalibrierungseinstellungen



Drücken Sie die Taste "Einstellungen", um den Einstellungsmodus aufzurufen.

Symbol	Beschreibung	Option	Funktion
	Kal-Kurve	T-CAL®	Wählt vorbereitete stabilisierte Formazin-Standards in vordefinierten Konzentrationen aus
		Anwender-Formazin	Wählt vom Anwender hergestellten Formazin-Standard in vordefinierten Konzentrationen aus
	Standard Set	Standard-einstellung	Wird verwendet, wenn keine eindeutige Kennung eingestellt ist.
		spezifisch	Eindeutiger Bezeichner des Standardsatzes.
	Erinnerung ¹⁾	an	Reminds user that calibration is due. Option to force Calibration before additional measurements occur.
		aus	Grundeinstellung
	Standard Kal		Option zur Rückkehr zur Werkskalibrierung.



Verifizierung

an Erfordert, dass der Benutzer nach Abschluss der Kalibrierung eine Verifizierung durchführt.

aus Grundeinstellung.



Kal Checker

an (Standard-einstellung) Wenn während des Kalibriervorgangs ein einzelner Standard außerhalb der Toleranz liegt, muss der Benutzer den Standard korrigieren, um fortzufahren oder den Kalibriervorgang abbrechen. Diese Funktion verhindert, dass der Benutzer einen Kalibrierungsfehler aufgrund eines falschen Standards macht. Der Protokollbildschirm enthält eine Zeile für den "Calibration Checker" und zeigt den Status "an" oder "Aktiviert" an.

aus Wenn während des Kalibrierungsvorgangs ein einzelner Standard außerhalb der Toleranz liegt, wird der Benutzer nicht benachrichtigt, dass ein Standard außerhalb des von Tintometer vordefinierten Bereichs liegt. Der Protokollbildschirm enthält eine Zeile für den "Calibration Checker" und zeigt den Status "Aus" oder "Deaktiviert" an.

¹⁾ nicht TB350

4.6 Verifikation

4.6.1 Anzeige der Verifikation

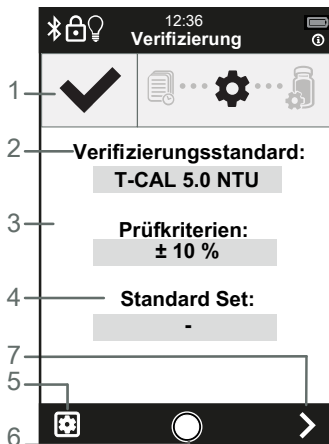

Beschreibung	Funktion
1 Anwendungsleiste	Navigationspfad, um den Benutzer durch die Prozessschritte zu führen.
2 Verifizierungsstandard	Wert des zu messenden Standards.
3 Prüfkriterien	Toleranz, die verwendet wird, um zu bestimmen, ob eine Verifizierung erfolgreich ist oder nicht.
4 Standard Set	Eindeutiger Bezeichner des Standardsatzes.
5 Taste "Einstellungen"	Dient zum Ändern von Einstellungen.
6 Taste "Home"	Bringt den Benutzer zum Startbildschirm zurück.
7 Taste "Weiter"	Weiter zur nächsten Anzeige.

4.6.2 Durchführen einer Verifizierung



1. Küvette vorbereiten:
Küvette bei Bedarf ölen.



3. Standard in das Gerät einsetzen:
Den auf dem Bildschirm angegebenen Standard einsetzen.



4. Aktion:
Steht für einen aktiven Prozess.



5. Protokoll-Zusammenfassung:
Drücken Sie die Taste "Speichern", um das Protokoll zu speichern.
Drücken Sie die Taste "Abbrechen", um zum Anfang des Verifikationsvorgangs zurückzukehren.

4.6.3 Verifikationseinstellungen



Drücken Sie die Taste "Einstellungen", um den Modus "Einstellungen" aufzurufen.

Symbol	Beschreibung	Option	Funktion
	Standard	T-CAL 5,0 NTU	Wählt einen vorbereiteten stabilisierten Formazin-Standard bei einer Konzentration von 5,0 NTU aus.
		Benutzer vorbereitet	Wählt den vom Benutzer vorbereiteten Standard zwischen 1 und 1000 NTU.
	Pass/Fail-Kriterien	±10%	Toleranz, die verwendet wird, um zu bestimmen, ob eine Verifizierung erfolgreich ist oder nicht.
		± 5%	
		±0,05 NTU	
		±0,10 NTU	
	Erinnerung¹⁾	an	Erinnert den Benutzer daran, dass eine Verifizierung fällig ist.
		aus	Voreinstellung.

¹⁾ nicht TB350

4.7 Protokolle

4.7.1 Auswahl einer Protokollart



Drücken Sie auf die Schaltfläche Protokolltyp im Aktionsbereich, um auf die Protokolle zuzugreifen.

Anwendungsleiste:



Messprotokolle:

Zeigt alle aufgezeichneten Messungen an.



Kalibrierungsprotokolle:
Zeigt alle Kalibrierungsprotokolle an.



Verifizierungsprotokoll:
Zeigt alle Verifizierungsprotokolle an.

¹⁾

GLP-Modus-Protokolle:
Zeigt an, ob der GLP-Modus aktiviert oder deaktiviert wurde.

¹⁾ nicht TB 350

DE

4.7.2 Abrufen eines Protokolls



1. Protokolltyp auswählen

Zeigt die Datensätze des Protokolltyps an, den der Benutzer ausgewählt hat.



2. Einzelne Protokolle exportieren

Wenn ein einzelner Datensatz ausgewählt wird, wird das Protokoll im CSV-Format exportiert.
Alle mit dem Protokoll verbundenen Details werden exportiert.



3. Wählen Sie die Übertragungsmethode

USB: Exportiert das Protokoll auf einen USB-Speicher.



Bluetooth[®] ¹⁾: Exportiert das Protokoll in die mobile Anwendung AquaLX.
Nicht verfügbar für TB 350.
Hinweis: Für den Anschluss an den USB-A-Anschluss ist ein externer Lovibond[®] Bluetooth[®]-Dongle erforderlich.

¹⁾ nicht TB 350

4.8 Geräteeinstellungen



Drücken Sie die Taste "Einstellungen", um den Modus "Geräteeinstellungen" aufzurufen.

Symbol	Beschreibung	Option	Funktion
	Sicherheit	Aktivieren	Passwort einrichten, überprüfen und ändern.
		deaktiviert	Standardeinstellung

**Energie-
einstellungen**

Bildschirmhelligkeit

Helligkeit des
Bildschirms einstellen.

Hintergrundlicht

 aus
 20 Sekunden
 30 Sekunden
 1 Minute*
 5 Minuten

Systemabschaltung

 aus
 1 Minute
 2 Minuten
 5 Minuten
 15 Minuten*

Hinweis: Wenn das USB-C-Netzkabel verwendet wird, wird die Systemabschaltung auf "Aus" gesetzt, bis das Gerät vom Stromnetz getrennt wird, und kehrt dann zur ausgewählten Option zurück.

Bluetooth¹⁾

Aktivieren

 Aktiviert Bluetooth®,
 wenn die Hardware
 vorhanden ist.

deaktiviert

Standardeinstellung

**USB-Ver-
knüpfungen¹⁾**

Aktivieren

 Wenn diese Option
 aktiviert ist, wird
 dem Benutzer beim
 Anschließen eines
 USB-Speichergeräts
 ein Dialogfenster
 angezeigt, in dem er die
 Option "Übertragung
 von Protokollen"
 oder "Sicherung/
 Wiederherstellung"
 auswählen kann. Durch
 Auswahl einer Option
 wird der Benutzer
 zur entsprechenden
 Funktion weitergeleitet.

deaktiviert

 Standardeinstellung;
 Benutzer müssen
 auf die Einstellungen
 "Protokolle"
 oder "Sichern/
 Wiederherstellen"
 zugreifen, wenn ein
 USB-Speichergerät
 angeschlossen ist.

**Sprache**

Sprache auswählen.

**Datum/
Uhrzeit**

Stellen Sie die Uhrzeit und das Datum ein.

**Backup/
Werkseinst.**Alle Einstellungen sichern¹⁾

Option zum Speichern der Einstellungen auf der lokalen SD-Karte oder auf einem externen USB-Laufwerk.

Alle Einstellungen wiederherstellen¹⁾

Stellt zuvor gespeicherte Einstellungen wieder her, die auf einer lokalen SD-Karte oder einem externen USB-Laufwerk gespeichert sind.

Zurück auf Werkseinstellungen

Setzt alle Einstellungen auf die Werkseinstellungen zurück. Gespeicherte Protokolle sind weiterhin verfügbar.

**Einheit**

NTU

Wählen Sie eine angezeigte Einheit.

FNU

mg.l Kaolin

mg.l PSL

Grad

mNTU¹⁾mFNU¹⁾Benutzerdefiniert¹⁾

Legt die Art der Einheit für den angezeigten Messwert fest. NTU ist die Standardeinstellung.

Benutzerdefinierte Einheiten und die Möglichkeit, einen Faktor auf der Grundlage von NTU/FNU-Werten festzulegen.

**GLP¹⁾**

Aktivieren

Legt ein Protokoll für die Datenintegrität von Laboratorien fest, die die Gute Laborpraxis befolgen.

deaktiviert

Standardeinstellung

**Inhaber**

Kontaktdaten des
Gerätebenutzers.

**Kontakt**

Kontaktinformationen
für Lovibond®-
Niederlassungen.

**Über**

Informationen über
Lovibond®.

¹⁾ nicht TB 350

* Standardeinstellung

5 Wartung

5.1 Empfohlener Wartungsplan

Aufgabe	Was zu tun ist	Was man nicht macht
1. Messschacht reinigen 2. Touchscreen reinigen	1. Stellen Sie sicher, dass der Messschacht vor der Messung sauber und trocken ist. Verwenden Sie ein trockenes Mikrofasertuch, um Verunreinigungen zu entfernen. 2. Wischen Sie den Touchscreen mit einem trockenen oder leicht feuchten Mikrofasertuch ab.	1. Sprühen oder gießen Sie keine Flüssigkeit direkt in den Messschacht. 2. Messen Sie keine Probe, die nicht fest verschlossen ist.
Äußeres Gehäuse reinigen	Reinigen Sie das Außengehäuse mit einer milden Spülmittellösung oder verdünntem Alkohol.	
Lagerung und Pflege von Probenküvetten	Spülen Sie die Küvetten nach Gebrauch immer mit trübungsfreiem Wasser aus.	Wischen Sie übermäßig aufgetragenes Silikonkonöl von der Küvette ab. Es ist nur ein einzelner Tropfen notwendig.
	Küvette mit VE-Wasser füllen. Küvette verschließen, um die Bildung von Wasserflecken zu vermeiden.	Lassen Sie die Probenküvetten nicht ohne Deckel an der Luft trocknen.
	Wischen Sie die Außenseite der Küvette mit einem Mikrofasertuch trocken.	Verwenden Sie keine Küvette mit sichtbaren Mängeln, wie z. B. Macken, Kratzer oder Risse.
Batteriewechsel	Es wird empfohlen, die Batterien zu entfernen, wenn das Gerät länger als 30 Tage gelagert wird, um ein Auslaufen der Batterien zu verhindern.	Keinen nicht spezifizierten Batterietypen verwenden.

Aufgabe	Was zu tun ist	Was man nicht macht
Kalibrierung	Kalibrieren Sie bei Bedarf unter den folgenden Bedingungen: <ol style="list-style-type: none"> 1. Verifizierungsfehler. 2. Wartung von optischen oder elektronischen Systemen. 3. Wie von den regionalen Aufsichtsbehörden gefordert. 	Keine abgelaufene Standards verwenden.
	Befolgen Sie sorgfältig die Anweisungen zur Vorbereitung und Anwendung der Standards.	
Verifizierung	Verifizieren Sie das Gerät unter den folgenden Bedingungen: <ol style="list-style-type: none"> 1. Nach der Durchführung einer Kalibrierung. 2. Gemäß den internen Qualitätskontrollverfahren. 3. Wie von den regionalen Regulierungsbehörden gefordert. 	Keine abgelaufenen Standards verwenden.
	Befolgen Sie sorgfältig die Anweisungen zur Vorbereitung und Verwendung der Standards.	
Stecker / Dichtung	Stellen Sie sicher, dass die Anschlussdichtung angebracht ist, wenn Sie sich nicht in einer Laborumgebung befinden.	Gerät nicht ohne angeschlossener Dichtung lagern.
		Gerät nicht an dem Anschlusskabel transportieren oder tragen.

**Warnung!**

Ein unsachgemäßer Umgang mit bestimmten Reagenzien kann Ihre Gesundheit schädigen. Befolgen Sie in jedem Fall die Angaben auf den Sicherheitsetiketten der Verpackung, die Sicherheitshinweise der Packungsbeilage und das verfügbare Sicherheitsdatenblatt. Dort festgelegte Schutzmaßnahmen müssen genau befolgt werden.

6 Fehlerbehebung

6.1 Fehlermeldungen und was zu tun ist

Anzeichen	Mögliche Ursache	Lösung
Messbereichs- überschreitung	Die Trübung der Probe liegt außerhalb des Messbereichs des Geräts.	<ul style="list-style-type: none"> • Probe verdünnen • Überprüfen Sie die Kalibrierung mit einem hohen Standard
Messbereichs- unterschreitung	Die Trübung der Probe liegt unter der Nachweisgrenze des Geräts	<ul style="list-style-type: none"> • Wiederholen Sie die Streulichtmessung (Nullabgleich) wie vorgeschrieben und achten Sie darauf, dass der Probendeckel geschlossen ist. • Wiederholen Sie die Kalibrierung, nachdem das Streulicht ausgeschlossen wurde.
Gerät schaltet sich nicht ein	Batterien sind defekt Batterien sind nicht richtig eingelegt	<ul style="list-style-type: none"> • Ersetzen Sie die Batterien durch einen komplett neuen Satz.
"Speichern" Taste für eine Funktion erscheint nicht, daher kann kein Protokoll erstellt werden.	Erforderliche Angaben fehlen	Vergewissern Sie sich, dass die Benutzernamen und alle anderen erforderlichen Felder korrekt ausgefüllt sind.
Gerät nimmt keine Messung vor	Messschachtdeckel ist nicht geschlossen	Messschachtdeckel schließen.
Meldung bei niedrigem Batteriestand	Batterieladung unter 20 %	Batterien austauschen oder Akkus laden
Geräteeinstellungen sind für den Benutzer nicht zugänglich	Gerätesicherheitsprotokoll ist aktiv	Geben Sie das Passwort ein, um Einstellungen und Kalibrierungsfunktionen freizuschalten
Kalibrierungsfehler	Probenküvette wurde vor der Kalibrierung nicht gereinigt	<ul style="list-style-type: none"> • Reinigen Sie die Probenküvette erneut wie im Handbuch beschrieben. Lagern Sie die Küvetten wie in der Anleitung beschrieben. • Verfallsdatum des Standards prüfen

Anzeichen	Mögliche Ursache	Lösung
Kalibrierungsfehler	Kalibrierstandards wurden in der falschen Reihenfolge verwendet.	Wiederholen Sie die Kalibrierung mit den Standards, vom niedrigsten zum höchsten Wert aufsteigend.
Kalibrierungsfehler	Kalibrierstandards wurden nicht ausreichend durchmischt.	Mischen Sie die Standards wie angegeben unmittelbar vor der Durchführung der Kalibrierung.
Kalibrierungsfehler	Kalibrierstandards auf falsche Trübungswerte eingestellt.	Wiederholen Sie die Vorbereitung der Kalibrierstandards und stellen Sie sicher, dass die Verdünnungen korrekt sind.
Verifikationsfehler	Verifizierung liegt außerhalb der Fehlergrenzen.	<ul style="list-style-type: none"> • Mischen Sie den Verifizierungsstandard vor der Verifizierung. • Überprüfen Sie die Bestanden/ Nichtbestanden-Kriterien, um sicherzustellen, dass die Kriterien nicht strenger sind als die Genauigkeit des Standards und passen Sie diese Kriterien entsprechend an. • Verfallsdatum des Standards prüfen

7 Zubehör & Ersatzteile

7.1 Zubehörliste

Titel		Bestell-Nr.
Batterien (AA), 4er Set	TB350 IR, TB350 WL	1950025
Bürste, 11 cm Länge	TB350 IR, TB350 WL	380230
Küvettenständer für 6 Rundküvetten Ø 24 mm	TB350 IR, TB350 WL	418951
Messküvetten mit schwarzem Deckel, Höhe 55 mm, ø 24 mm, 12er Set	TB350 IR, TB350 WL	197655
Netzteil TB-Serie	TB350 IR, TB350 WL	19820-170
Rechargeable battery pack, Ni-MH	TB350 IR, TB350 WL	19820-011
Reinigungstuch	TB350 IR, TB350 WL	197635
Satz Trübungsstandards T-CAL (5, 20, 800, 2000, 4000 NTU)	TB350 WL	194152
Satz Trübungsstandards T-CAL (5, 20, 800, 4000 NTU)	TB350 IR	194154
Silikonöl	TB350 IR, TB350 WL	194295
T-CAL®-Standard, 4000 NTU, 125 ml	TB350 IR, TB350 WL	48012912
T-CAL®-Standard, 4000 NTU, 500 ml	TB350 IR, TB350 WL	48012950
USB-C-Kabel 1 m, USB-C auf A	TB350 IR, TB350 WL	19820-081

7.2 Ersatzteile

Beschreibung	Bestellnummer
Transportkoffer	19820-130
Deckel, Messschacht	19820-095
Deckel, Batteriefach	19820-098
Stecker, elastomer, IP67, I/O	19820-084
Einsatz für 4 AA Batterien	19820-012

8 Spezifikationen

Model	Model WM-040-1004 (IR) Model WM-040-1001 (WL)
Lichtquelle	Infrarot LED (860 nm) Weißlicht (LED)
Einhaltung von Vorschriften	ISO 7027 EPA zugelassen (alternativ zu US EPA 180.1)
Messprinzip	Nephelometrisch (Multipath 90° BLAC)
Messbereich	0,01 - 4000 NTU (FNU)
Messwertauflösung	Autoranging: 0.01-9.99: 0.01 NTU ; 10.0-99.9: 0.1 NTU ; 100-4000: 1 NTU
Genauigkeit	± 1,8 % vom Messergebnis + Streulicht
Wiederholbarkeit	< 1 % oder ± 0,01 NTU
Streulicht	< 0.014 NTU
Angezeigte Einheit	NTU, FNU, Grad, mg/L Kaolin, mg/L PSL
Reaktionszeit	7 Sekunden
Lesemodi	Single, Signaldurchschnitt, Fast-Settling
Kalibrierungsoptionen	Vollbereichskalibrierung von 0 - 4000 NTU
Detektor	Silizium-Fotodiode
Ratio Modus	Ja
Benötigtes Probenvolumen	10 mL (0,4 oz)
Display	Vollfarbiger Touchscreen
Displaygröße	55 x 95 mm (W x H)
Schnittstellen	<ul style="list-style-type: none"> • USB-A • USB-C
Datenlogger	250 Messungen, alle Kalibrierungen, Verifizierungen und Werkswiederherstellungen
Datenübertragungsformat	.csv
Stromsparmodus	Ja
Auto – OFF	Auswählbar
Stromversorgung	<ul style="list-style-type: none"> • 3 NiMH-battery pack (AA) • 4 batteries (AA) • Universal (90 - 240 VAC), via external power supply

Umgebungsbedingungen	Temperatur: 0 - 50 °C (32 - 122 °F) Luftfeuchtigkeit: 0 - 90 % bei 30 °C, nicht kondensierend Luftfeuchtigkeit: 0 - 80 % bei 40 °C, nicht kondensierend Luftfeuchtigkeit: 0 - 70% bei 60 °C, nicht kondensierend
Schutzklasse	IP 67 (Gerät)
Konformität	- <ul style="list-style-type: none"> • CE • CSA • FCC A • RoHS • TÜV • UL • WEE
Sprachen Benutzeroberfläche	<ul style="list-style-type: none"> • Chinesisch • Deutsch • Englisch • Französisch • Japanisch • Niederländisch • Polnisch • Portugiesisch • Spanisch • Türkisch
Sprachen Kurzanleitung	<ul style="list-style-type: none"> • Chinesisch • Deutsch • Englisch • Französisch • Italienisch • Niederländisch • Portugiesisch • Russisch • Spanisch • Türkisch

Sprachen Bedienungsanleitung	<ul style="list-style-type: none"> • Chinesisch • Deutsch • Englisch • Französisch • Italienisch • Niederländisch • Portugiesisch • Russisch • Spanisch • Türkisch
Abmessungen	155 x 83 x 225 mm
Gewicht	804 g (898 g with four AA alkaline batteries)
Gewicht mit Verpackung	(898 g with four AA alkaline batteries)

**Vorsicht!**

Technische Änderungen vorbehalten!
Um eine maximale Genauigkeit der Testergebnisse zu gewährleisten, verwenden Sie immer die vom Gerätehersteller gelieferten Reagenzsysteme.

8.1 Spezifikationen - Netzadapter

Typ	WR9QA2500USB52NMR6B
Design	Steckernetzteil, Schaltnetzteil
Eingangsspannung, Frequenz	100 – 240 V \pm 10 %, 50 / 60 Hz \pm 5 %
Eingangsstrom	0,3 A
Primär-Adapter	Europa, UK, Australien, USA
Schutzklasse	II
Ausgangsspannung, Frequenz	5,2 V, DC
Max. Ausgangsstrom	2,5 A
Ausgangssicherung	Abschaltung und automatischer Neustart des Ausgangs
Umgebungsbedingungen	0 °C bis 40 °C, mit max. 95 % relativer Luftfeuchtigkeit
Energieeffizienzklasse	VI
Sicherheitsstandard	EN 62368

Typ **WR9QA2500USB52NMR6B**

EMC	EN 55032 FCC Part 15 Class A EN 55024
-----	---

Abmessungen [mm]	31,5 x 41 x 71 (ohne Primäradapter)
------------------	-------------------------------------

Gewicht, mit EU Adapter	48 g (ohne primäre Adapterflügel)
-------------------------	-----------------------------------

Zulassung, EMC	CE, FCC
----------------	---------

Zugelassene Höhenmeter	5000 m
------------------------	--------

Verschmutzungsgrad	2
--------------------	---

**Vorsicht!**

Technische Änderungen vorbehalten!
Um eine maximale Genauigkeit der Testergebnisse zu gewährleisten, verwenden Sie immer die vom Gerätehersteller gelieferten Reagenzsysteme.

9 Appendix

9.1 Hinweis zu Copyright und Warenzeichen

Lovibond®, Tintometer® und T-CAL® sind eingetragene Marken der Tintometer Firmengruppe. Alle Übersetzungen und Umschreibungen von Lovibond® und Tintometer® werden als Marken von The Tintometer® Group geltend gemacht. Die Bluetooth®-Marke, die Bildmarke und die Kombinationsmarke sind Marken im Besitz der Bluetooth SIG, und jegliche Verwendung durch die Tintometer®-Gruppe erfolgt unter Lizenz.

DE

Contenido

ES

	Página
1 Introducción	84
1.1 Información general	84
1.1.1 Leer las instrucciones antes de usar	84
1.1.2 Finalidad del producto	84
1.1.3 Uso autorizado	84
1.1.4 Requisitos para un uso seguro	84
1.1.5 Conserve las instrucciones	85
1.1.6 Cualificación del usuario	85
1.1.7 Manipulación de productos químicos peligrosos	85
1.1.8 Instrucciones de eliminación	85
1.2 Lista de todos los símbolos utilizados en el documento	86
1.3 Abreviaturas	86
2 Resumen del producto	87
2.1 Certificación	87
2.2 Características	88
2.3 Descripción del producto	88
2.4 Vista del instrumento	88
3 Puesta en funcionamiento	90
3.1 Entorno operativo	90
3.2 Contenido de la entrega	90
3.3 Colocación y sustitución de las pilas/baterías	91
4 Operación	93
4.1 Primera puesta en marcha	93
4.2 Principios generales de funcionamiento	94
4.3 Lista de elementos de control y su función	95
4.3.1 Lista de elementos de control y su función	95
4.3.2 Lista de elementos de control y su función	96
4.3.3 Barra de estado	98
4.4 Medición	99
4.4.1 Resumen de mediciones	99
4.4.2 Realizar una medición	100
4.4.3 Consejos de medición	101
4.4.4 Ajustes de medición	102
4.5 Calibración	103
4.5.1 Visión general de la calibración	103
4.5.2 Realización de una calibración	103
4.5.3 Ajustes de calibración	104

	Página
4.6 Verification	105
4.6.1 Resumen de la verificación	105
4.6.2 Realización de una verificación	106
4.6.3 Configuración de la verificación	107
4.7 Registros	107
4.7.1 Seleccionar un tipo de registro	107
4.7.2 Recuperar un registro	108
4.8 Ajustes del instrumento	108
5 Mantenimiento	112
5.1 Programa de mantenimiento delete reanudado	112
6 Resolución de problemas	114
6.1 Mensajes de error y qué hacer	114
7 Accesorios y piezas de repuesto	116
7.1 Lista de accesorios	116
7.2 Lista de accesorios	116
8 Especificaciones	117
8.1 Especificaciones - Adaptador de red	119
9 Apéndice	121
9.1 Aviso de derechos de autor y marcas comerciales	121

1 Introducción

1.1 Información general

1.1.1 Leer las instrucciones antes de usar

Este manual proporciona información importante sobre el funcionamiento seguro del producto. Lea atentamente este manual y familiarícese con el producto antes de utilizarlo.

1.1.2 Finalidad del producto

El turbidímetro portátil de la serie TB está diseñado para analizar muestras acuosas que se recogen en cubetas de vidrio y luego se sellan. La cubeta se prepara para la medición utilizando una técnica cuidadosa para minimizar la interferencia del polvo y los arañazos. Después de la preparación, la cubeta se coloca en el instrumento para la medición.

El instrumento puede utilizarse en el laboratorio o llevarse al campo para realizar mediciones en las muestras a medida que se recogen.

Se debe tener cuidado al transportar este turbidímetro. Si el instrumento se lleva al campo, debe utilizarse el estuche de transporte. Si el instrumento se va a utilizar para aplicaciones reguladas, es aconsejable ponerse en contacto con las autoridades locales para asegurarse de que se selecciona el modelo de instrumento correcto.

1.1.3 Uso autorizado

La responsabilidad del fabricante y la garantía sobre daños en el instrumento quedan anuladas en caso de realizar un uso impropio del mismo, ignorar las instrucciones de este manual, el uso del instrumento por parte de personal no cualificado o modificaciones no autorizadas del instrumento.

El fabricante no es responsable por los costes o daños que pueda recibir un tercero o un usuario debido al uso de este producto, especialmente en casos de uso impropio o de defectos en la conexión del mismo.

El fabricante no asume ninguna responsabilidad por errores de imprenta.

1.1.4 Requisitos para un uso seguro

Tenga en cuenta los siguientes puntos para un uso seguro del aparato:

- Si el equipo se utiliza de una manera no especificada por el fabricante, la protección proporcionada por el equipo puede verse afectada.
- El producto sólo puede utilizarse de acuerdo con el uso autorizado especificado anteriormente.
- El producto sólo puede ser alimentado por las fuentes de energía mencionadas en este manual de instrucciones.
- El producto sólo puede utilizarse en las condiciones ambientales mencionadas en este manual de instrucciones.
- El producto no debe abrirse ni modificarse.

El producto no debe utilizarse si:

- está visiblemente dañado (por ejemplo, después de ser transportado)
- se ha almacenado en condiciones adversas durante un largo periodo de tiempo (condiciones de almacenamiento, véase el capítulo "Especificaciones")

Requisitos para el uso seguro de la fuente de alimentación enchufable

Tenga en cuenta los siguientes puntos para un uso seguro:

- Compruebe que no hay daños visibles antes de utilizarlo. Si está dañado, no lo ponga en funcionamiento.
- Utilizar sólo en ambientes secos.
- Manipule el aparato sólo con las manos secas.
- Solo puede utilizarse la fuente de alimentación recomendada por el fabricante.
- El producto no debe abrirse ni modificarse.
- Solo puede utilizarse el cable USB-C recomendado por el fabricante para alimentar el dispositivo.

ES

1.1.5 Conserve las instrucciones

El manual debe guardarse cerca del producto para que siempre pueda encontrar la información que necesita.

1.1.6 Cualificación del usuario

El personal de servicio debe ser capaz de comprender y aplicar correctamente las etiquetas de seguridad y las instrucciones de seguridad que figuran en los envases y los insertos de los productos.

El usuario debe ser capaz y entender este manual para familiarizarse con el manejo y garantizar un uso seguro.

1.1.7 Manipulación de productos químicos peligrosos

Pueden existir riesgos químicos y/o biológicos cuando se utiliza este producto. Respete todas las leyes, reglamentos y protocolos vigentes cuando utilice este producto.

Para el desarrollo de los productos, Lovibond presta mucha atención a la seguridad.

Algunos riesgos derivados de sustancias peligrosas no pueden evitarse. Si se utilizan pruebas o soluciones de producción propia, la responsabilidad relativa a los riesgos causados por dichas pruebas o soluciones recae en el usuario (responsabilidad personal).

Para su propia protección, en el caso de estándares de turbidez superiores a 5 NTU, se recomienda utilizar guantes o gafas de protección. Observe la hoja de datos de seguridad correspondiente.

Las fichas de seguridad de los productos químicos comprenden todas las instrucciones sobre la manipulación segura, los peligros que se presentan, las acciones preventivas y las medidas que se deben tomar en situaciones de peligro.

1.1.8 Instrucciones de eliminación

Elimine las baterías y el equipo eléctrico en una instalación adecuada de acuerdo con la legislación local.

Es ilegal eliminar las pilas con la basura doméstica.

En la Unión Europea, al final de la vida útil del aparato, las pilas se eliminan en un punto de recogida especializado en reciclaje.



Los instrumentos marcados con este símbolo no deben eliminarse con la basura doméstica normal.

ES

1.2 Lista de todos los símbolos utilizados en el documento

Los siguientes símbolos se utilizan en este manual para indicar las secciones que requieren una atención especial:



¡Peligro!

Existe un peligro que provocará la muerte o lesiones graves si no se evita.



¡Atención!

La manipulación incorrecta de ciertos reactivos puede dañar su salud. En cualquier caso, siga la información de las etiquetas de seguridad del envase, las instrucciones de seguridad del prospecto y la hoja de datos de seguridad disponible. Las medidas de protección allí especificadas deben seguirse con exactitud.



¡Precaución!

Existe un peligro que puede provocar lesiones leves o moderadas.

1.3 Abreviaturas

Abreviaturas	Definición
NTU	Unidades Nefelométricas de Turbidez
FNU	Unidades Nefelométricas de Formazina
mg/l	Miligramo por litro

2 Resumen del producto

2.1 Certificación

EMC Emisiones conducidas y radiadas	CISPR 11 (Límites de la clase A)	Marca CE
Inmunidad EMC	EN 61326-1 (Límites industriales)	Marca CE
Seguridad	EN 61010-1	Marca de seguridad TÜV
FCC	FCC clase A	Marca FCC

Aviso de la clase A de la FCC

Este dispositivo cumple con la parte 15 de las normas de la FCC. Su funcionamiento está sujeto a las dos condiciones siguientes:

- Este dispositivo no puede causar interferencias perjudiciales.
- Este dispositivo debe aceptar cualquier interferencia recibida, incluidas las que puedan causar un funcionamiento no deseado.

Nota: Este equipo ha sido probado y se ha comprobado que cumple con los límites de un dispositivo digital de clase A, de acuerdo con la parte 15 de las normas de la FCC. Estos límites están diseñados para proporcionar una protección razonable contra las interferencias perjudiciales cuando el equipo se utiliza en un entorno comercial. Este equipo genera, utiliza y puede irradiar energía de radiofrecuencia y, si no se instala y utiliza de acuerdo con el manual de instrucciones, puede causar interferencias perjudiciales en las comunicaciones por radio. El funcionamiento de este equipo en una zona residencial puede causar interferencias perjudiciales, en cuyo caso el usuario deberá corregir las interferencias a su cargo.

Cables apantallados



Las conexiones entre el sistema y sus periféricos deben realizarse con cables apantallados para mantener el cumplimiento de los límites de emisión de radiofrecuencia de la FCC.

Precaución!

Modificaciones



Cualquier modificación realizada en este dispositivo que no esté aprobada por Tintometer puede anular la autoridad otorgada al usuario por la FCC para operar este equipo.

Precaución!

Aviso de DOC Clase A - Avis DOC, Clase A

Este aparato digital de clase A cumple todos los requisitos de la normativa canadiense sobre equipos causantes de interferencias.

2.2 Características

La precisión del laboratorio se une a la portabilidad





La serie Lovibond® TB elimina las complejidades en la medición de la turbidez. Esta nueva tecnología proporciona el más alto nivel de precisión y eficiencia operativa y normativa.

- Interfaz de pantalla táctil para facilitar el manejo
- Instrucciones con imágenes para guiar al usuario en los pasos del proceso y evitar errores.
- Protocolos sencillos de gestión de datos para garantizar su integridad

2.3 Descripción del producto

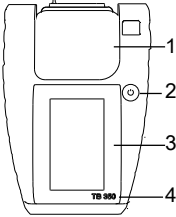
La turbidez es una expresión de las propiedades ópticas de una muestra que hace que los rayos de luz se dispersen y absorban en lugar de transmitirse en líneas rectas a través de una muestra fluida. En el agua, la turbidez suele estar causada por la presencia de materia como arcilla, limo, materia orgánica finamente dividida, plancton, otros organismos microscópicos, ácidos orgánicos y pigmentos. La medición de la turbidez se utiliza para controlar los procesos que eliminan o alteran las concentraciones de partículas en las soluciones, como en la producción de agua potable. Estos turbidímetros Lovibond® están diseñados para combinar la alta precisión y la alta sensibilidad que se espera de un turbidímetro de laboratorio con la portabilidad.

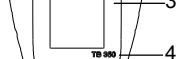
2.4 Vista del instrumento

Posición	Descripción	Función
	1. Tapa	Cuando se levanta, permite al usuario colocar la cubeta de muestra en el instrumento para una lectura.
	2. Botón de encendido	Enciende y apaga el instrumento.
	3. Pantalla táctil	Muestra la interfaz de usuario del instrumento.
	4. Número de modelo	Identifica la versión del instrumento.

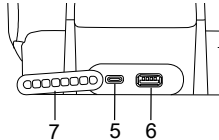
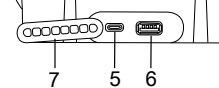
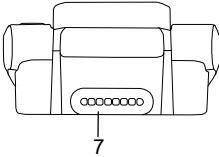
Posición	Descripción	Función
	5. Puerto USB-C	Suministra energía al instrumento desde una fuente externa o recarga el accesorio del paquete de baterías (si está instalado).
	6. Puerto USB-A	Admite un dispositivo USB-A externo para funciones como la transferencia de datos o las copias de seguridad.
	7. Cubierta	Se utiliza para cubrir los puertos USB cuando las conexiones no están en uso.

ES

3 Puesta en funcionamiento

3.1 Entorno operativo

El instrumento puede utilizarse en cualquier entorno interior o exterior que se considere seguro para que un operador realice el análisis.

El instrumento puede aceptar muestras acuosas de 0 a 70 °C.

El instrumento debe estar nivelado $\pm 15^\circ$ al realizar una medición.

El instrumento debe colocarse en una superficie nivelada para lograr el mejor rendimiento de la medición.

ES

3.2 Contenido de la entrega

Inspeccione cuidadosamente todos los artículos para asegurarse de que todas las partes de la lista de abajo están presentes y que no se ha producido ningún daño visible durante el envío. Si hay algún daño o falta algo, póngase en contacto con su distribuidor local inmediatamente.

TB	350 IR	350 WL
Instrumento	X	X
Aceite de silicona, 15 ml	X	X
Paño de microfibra	X	X
2 x cubetas de muestra	X	X
Destornillador	X	X
Cepillo	X	X
Estuche con inserción	X	X
Guía de inicio rápido	X	X
Certificado de conformidad	X	X
Folleto de la garantía	X	X
4 pilas AA	X	X
Pack de baterías recargables		
Cable USB-C		
Fuente de alimentación de CA		
Adaptador para enchufes de EE.UU., Reino Unido y la UE		
T-CAL® Standard, 5 NTU	X	X
T-CAL® Standard, 20 NTU	X	X
T-CAL® Standard, 800 NTU	X	X
T-CAL® Standard, 2000 NTU		X
T-CAL® Standard, 4000 NTU	X	X

3.3 Colocación y sustitución de las pilas/baterías

Cuando se utilizan baterías

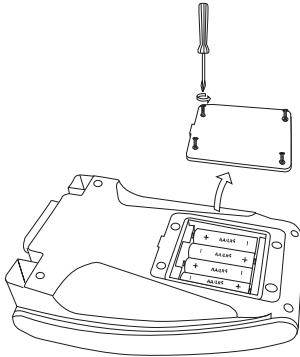

Paso	Descripción
1	Utilice un destornillador para quitar los cuatro tornillos de la parte posterior del instrumento y retire el panel.
2	Inserte cuatro pilas AA en la orientación correcta.
3	Vuelva a colocar el panel en el instrumento.



Precaución

- Utilice únicamente el tipo aprobado: pila alcalina de manganeso, LR6, con una tensión de 1,5V.
- Retire las pilas vacías del aparato lo antes posible.
- Si el aparato no se utiliza durante mucho tiempo, retire las pilas del aparato.

Cuando se utilizan paquete de baterías recargables

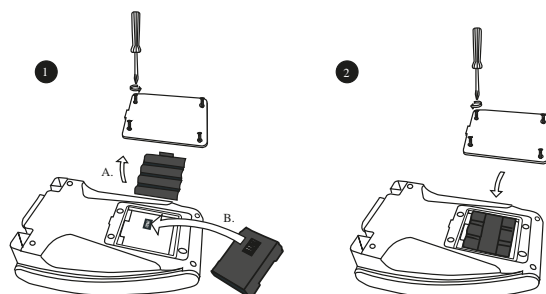

ES

Paso	Descripción
1	Utilice un destornillador para quitar los cuatro tornillos de la parte posterior del instrumento, retire el panel y la bandeja de las pilas.
2	Inserte el paquete de baterías recargables en la orientación correcta.
3	Vuelva a colocar el panel en el instrumento.



¡Atención!

El paquete de baterías recargables (19820-011) sólo es compatible con instrumentos con el número de serie 23041000 y superiores.

El uso del paquete de baterías para instrumentos con números de serie anteriores a 23041000 puede provocar el sobrecalentamiento del dispositivo durante la carga. Este sobrecalentamiento puede provocar lecturas incorrectas y daños en el dispositivo, por lo que debe evitarse.

Para instrumentos con número de serie inferior a 23041000, póngase en contacto con Lovibond® para obtener información detallada sobre cómo utilizar este accesorio.

4 Operación

4.1 Primera puesta en marcha



1. Pantalla de bienvenida

Pantalla inicial al encender el instrumento por primera vez
Pulse el botón >



2. Seleccione el idioma

Seleccione el idioma deseado para establecer
Pulse el botón >



3. Establecer la fecha y la hora

Elija entre el formato de 12 y 24 horas.
Modificar los valores con las flechas arriba y abajo.
Pulse el botón >



4. Contraseña

Establezca una contraseña seleccionada por el usuario para implementar funciones de seguridad en el instrumento.
Pulse el botón de guardar.
Si no desea ninguna contraseña, seleccione "Saltar".
Pulse el botón >



5. Unidades por defecto

Seleccione el tipo de unidad que desea establecer.
Pulse el botón >



6. Datos de contacto

Introduzca la información del propietario del instrumento.
Pulse el botón de guardar.
Si no desea ningún detalle, seleccione "Saltar".
Pulse el botón >



7. Pantalla de resumen

Revisión de la configuración inicial.
Pulse < para cambiar la configuración antes de continuar.
Pulse > para continuar con la pantalla de inicio.
El usuario puede seleccionar la tarea a realizar con el instrumento.

4.2 Principios generales de funcionamiento

Los diseños de los turbidímetros portátiles de la serie TB se desglosan en sus respectivos componentes funcionales que se discuten en detalle. Estos incluyen la fuente de luz, la trampa de luz difusa de 90 grados, el detector de luz difusa, el vial de muestra del turbidímetro y cómo estos componentes clave trabajan juntos para ofrecer el resultado de turbidez.

ES

La configuración óptica simplificada para la serie TB de turbidímetros portátiles. Esta figura muestra la trayectoria de la luz incidente y la vista del detector de luz dispersa a 90°.

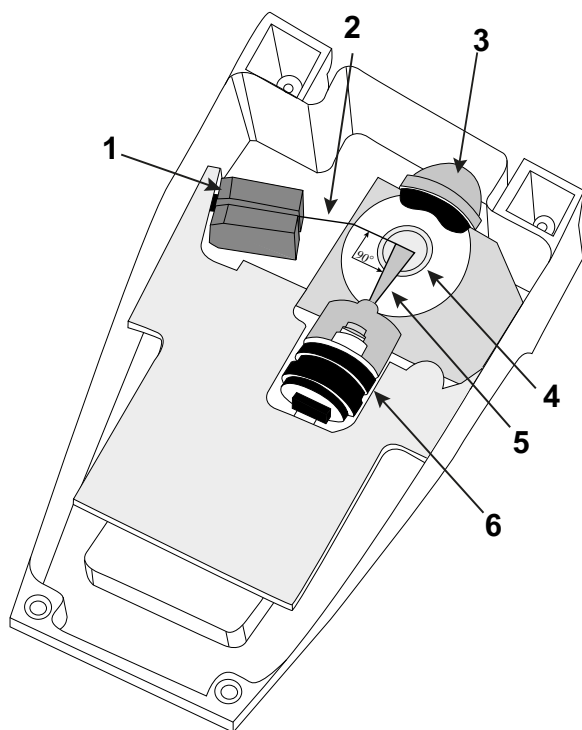





- 1 Iluminador (LED y óptica)
- 2 Trayectoria de la luz incidente
- 3 90° Trampa para luces parásitas
- 4 Vial de muestra
- 5 Luz difusa (10°-20° vista del detector)
- 6 Detector de luz difusa y óptica



4.3 Lista de elementos de control y su función

4.3.1 Lista de elementos de control y su función



Descripción	Función
1 Barra de estado	Muestra los iconos y etiquetas que son universales, incluyendo Hora, Bluetooth®, USB, Seguridad, Fuente de luz y Alimentación.
2 Área de acción	Área que muestra los pasos de la aplicación y la interacción.
3 Inicio	Se utiliza principalmente para la navegación, para iniciar o guardar o descartar acciones y volver a casa.

Icono	Descripción
	Modo de medición
	Modo de calibración
	Modo de verificación
	Registros de datos

Icono	Descripción
	Conexión Bluetooth con el turbidímetro de proceso PTV (no disponible para el TB 350)
	Ajustes del instrumento

ES

4.3.2 Lista de elementos de control y su función

Icono	Descripción	Función
	Nombre de la aplicación	Título de la aplicación que el usuario está utilizando actualmente.
	Tiempo	La hora la establece el usuario en la configuración inicial o accediendo a los ajustes del instrumento. Está disponible el formato de 12 o 24 horas.
	USB	Si se muestra, indica que hay un módulo USB conectado a la unidad.
	Icono Bluetooth - Plain ²⁾	Si se muestra, el módulo Bluetooth® está conectado.
	Icono Bluetooth - Con flechas ²⁾	Si se muestra, el módulo Bluetooth® está conectado y se comunica activamente con un PTV o una aplicación AquaLX.
	Fuente de luz roja - rellena	El instrumento contiene una fuente de luz LED roja; la luz se enciende para la medición.
	Fuente de luz roja - Esquema	El instrumento contiene una fuente de luz LED roja; no hay ninguna medición activa.
	Fuente de luz blanca - rellena	El instrumento contiene una fuente de luz LED blanca; la luz se enciende para la medición.
	Fuente de luz blanca - Outline	El instrumento contiene una fuente de luz LED blanca; no hay ninguna medición activa.



Icono	Descripción	Función
	Fuente de luz infrarroja - Encendido	El instrumento contiene una fuente de luz LED infrarroja; la luz se enciende para la medición.
	Fuente de luz infrarroja - Apagado	El instrumento contiene una fuente de luz LED infrarroja; no hay ninguna medición activa.
	Fuente de luz láser - rellena ¹⁾	El instrumento contiene una fuente de luz LED láser; la luz se enciende para la medición.
	Fuente de luz láser - Outline ¹⁾	El instrumento contiene una fuente de luz LED láser; no hay ninguna medición activa.
	Carga de la batería de CA	La batería de CA se está cargando.
	Icono de alimentación de CA	Indica que el instrumento está alimentado por corriente alterna.
	Energía de la batería - Verde	Indica que queda el 100% de la vida útil de la batería.
	Energía de la batería - Amarillo	Indica que queda el 75% de la vida útil de la batería.
	Energía de la batería - Naranja	Indica que queda el 50% de la vida útil de la batería.
	Energía de la batería - Rojo	Indica que queda el 25% de la vida útil de la batería.
	Tapa de compartimento de medición abrió	Indica que la tapa de compartimento de medición está abierta.
	Tapa de compartimento de medición cerrado	Indica que la tapa de compartimento de medición está cerrada.

¹⁾ sólo TB 600

2) no TB 350

4.3.3 Barra de estado

Icono	Descripción	Función
	Botón de inicio	Devuelve al usuario a la pantalla de inicio.
	Botón de inicio - Bloqueado	La seguridad está activada; la contraseña ha sido activada y es necesaria para realizar ciertas funciones.
	Botón de inicio - Desbloqueado	La seguridad está inactiva; ninguna función está bloqueada para el usuario.
	Botón de guardar	Guarda el contenido mostrado en el área activa.
	Botón de configuración	Abre el menú de configuración de una aplicación.
	Botón de exportación	Exporta el(los) registro(s) mostrado(s) en el área activa.
	Botón de medición	Comienza o inicia una medición.
	Botón de medición - con Bluetooth ⁽²⁾	Realiza una medición mientras está conectado a una unidad PTV.
	Botón de actualización de Bluetooth ⁽²⁾	Actualiza la lista de unidades PTV disponibles en las proximidades del instrumento.

Icono	Descripción	Función
	Botón de cancelación	Da la opción de cancelar la actividad actual en el área activa.
	Chevron derecho	Avanzar al siguiente paso dentro de un proceso.
	Chevron izquierdo	Volver a un paso anterior dentro de un proceso.

²⁾ no TB350

4.4 Medición

4.4.1 Resumen de mediciones

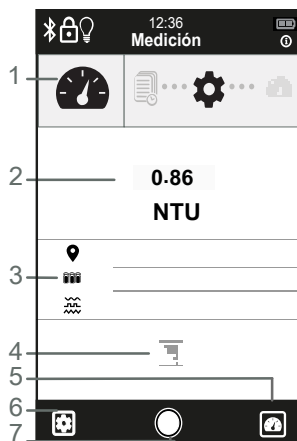

Descripción	Función
1 Barra de aplicaciones	Ruta de navegación para ayudar al usuario en los pasos del proceso.
2 Valor de medición	Visualización del resultado con la unidad seleccionada.
3 Ajustes	Se muestran los ajustes aplicados a la medición.
4 "Protocol" button	Crea un registro cuando se pulsa.
5 Botón "Medición"	Inicia una medición cuando se pulsa.
6 Botón "Configuración"	Sirve para cambiar los ajustes.

Descripción**Función**

7 Botón "Home" (Inicio) Devuelve al usuario a la pantalla de inicio.

4.4.2 Realizar una medición

Por favor, prepare las cubetas de muestra incluidas en el volumen de suministro antes de la medición. Asegúrese de que las cubetas de muestra no tengan manchas, arañazos ni imperfecciones.

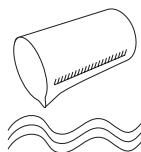
**1. Recoger la muestra**

Asegúrese de que la muestra es representativa (bien mezclada). El material de vidrio debe estar libre de manchas, arañazos u otras imperfecciones. Enjuague el recipiente de recogida al menos dos veces con la muestra antes de recogerla.

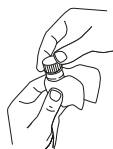
**2. Preparar la cubeta**

Con un paño que no suelte pelusa, secar el exterior del vial de muestra. Utilice aceite de silicona para minimizar los reflejos de luz parásita.

**3. Insertar el vial en el instrumento**

Asegúrese de que la muestra no tiene burbujas. Invierta lentamente para mezclar. No agitar.

**4. Cierre la tapa**

No se permitirá la medición sin la tapa colocada.

**5. Compruebe los ajustes**

Asegúrese de que los ajustes de medición son correctos. Los ajustes para la medición no se pueden cambiar después de que se produzca la medición.

**6. Pulse el botón de medición**

Inicia la medición.

**7. Registro de datos**

Entre en el registro de datos para guardar la medición.

**8. Guardar medición**

Si lo desea, pulse el botón Guardar para crear un registro de mediciones.



9. Pausa

Pone en pausa la medición en el modo de medición "continuo".



- No introduzca ningún objeto en la cámara de medición, excepto las cubetas destinadas a las mediciones.
- No introduzca ningún líquido en la cámara.

¡Atención!

ES

4.4.3 Consejos de medición

Indexación del vial: La mejor manera de hacerlo es con un vial lleno de agua filtrada a través de un filtro de 0,2 μm .

- Pulse el botón de medición.
- Gire la muestra. Mientras gira el vial, identifique la lectura más baja.
- Cuando se determine la posición, detenga la medición. Marque la ampolla.
- Antes de proceder a otras mediciones, asegúrese de que el modo de medición está actualizado, según sea necesario.
- Se recomienda marcar la ampolla de la muestra si hay un rasguño o una fosa notable en la cristalería.

Uso del aceite de silicona

- Tenga cuidado de manipular el vial sólo por el tercio superior.
- Limpie la ampolla con el paño de limpieza suministrado para eliminar el agua, el polvo y las huellas dactilares.
- Unte el exterior del vial con aceite de silicona.
 - Coloque un cordón muy fino de aceite de silicona en el lateral del vial. Distribuya uniformemente la gota de aceite sobre los 2/3 del fondo del vial.
 - Limpie la silicona del vial mediante la rotación del mismo contra un paño limpio y sin polvo.
- La lubricación de las cubetas es fundamental y se recomienda cuando se miden muestras con una turbidez prevista inferior a 0,5 NTU.

Muestras con exceso de burbujas

- Deje reposar la muestra durante un mínimo de cinco minutos.
- Invierta suavemente la muestra dos o tres veces para resuspender la turbidez.
- Colóquela en el instrumento y proceda según las instrucciones.

Otras notas

- No se recomienda el uso de baños de ultrasonidos. La energía ultrasónica puede cambiar la distribución de las partículas.
- Utilice el modo de ajuste rápido para las muestras que tienen altas concentraciones de arenas o partículas de alta densidad.

4.4.4 Ajustes de medición



Pulse el botón de configuración para acceder al modo de configuración de las mediciones.

ES

Icono	Descripción	Opción	Función
	Modo	Individual	Empuje para leer.
		Continuo ¹⁾	Measurement updates every X seconds until stopped.
		Muestra con sedimentos	Recommended for samples with rapid settling characteristics.
	Ubicación	Predeterminado	Se utiliza si no se establece un ID personalizado.
		Personalizado	Descripción personalizada del lugar de medición y de los límites de medición.
	Promedio de señal	Encendido	Si está activada, se pueden establecer hasta 255 mediciones. La función debe utilizarse si las mediciones son inestables.
		Apagado	Desactivado
	Ejemplo de identificación	Predeterminado	Se utiliza si no se establece un ID personalizado.
		Personalizado	Identificador único de la muestra; seleccionable por el usuario.

¹⁾ no TB350

4.5 Calibración

4.5.1 Visión general de la calibración

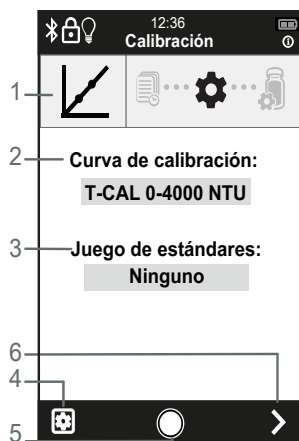

Descripción	Función
1 Barra de aplicaciones	Ruta de navegación para ayudar al usuario en los pasos del proceso.
2 Curva de calibración	Especifica el tipo de calibración.
3 Juego de estándares	Identificador único del conjunto de estándares.
4 Botón "Configuración"	Sirve para cambiar los ajustes.
5 Botón "Home" (Inicio)	Devuelve al usuario a la pantalla de inicio.
6 Botón "Siguiente"	Avanza a la siguiente pantalla.

4.5.2 Realización de una calibración

Prepare los estándares T-CAL® incluidos en el volumen de suministro antes de la calibración. Asegúrese de que los frascos de T-CAL® no tengan manchas, arañazos o imperfecciones.

- Estándares T-CAL® para TB 350 IR: 20 / 800 / 4000 NTU
- Estándares T-CAL® para TB 350 WL: 20 / 800 / 2000 / 4000 NTU

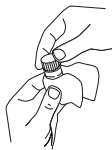

- 1. Ajuste cero:**
Realiza un ajuste del cero.

**2. Prepare la cubeta:**

Cubeta de muestra, aceite si es necesario.

**3. Insertar estándar:**

Inserta el valor estándar especificado en la pantalla.

El usuario insertará series de varios estándares de turbidez para completar la calibración.

**4. Modal:**

Representa el proceso activo.

**5. Resumen del registro:**



Pulse el botón Guardar para guardar el registro.

Pulse el botón Cancelar para volver al principio del proceso de calibración.

4.5.3 Ajustes de calibración

Pulse el botón de configuración para acceder al modo de configuración.

Icono	Descripción	Opción	Función
	Curva de calibrado	T-CAL®	Selecciona el estándar de formazina estabilizado preparado en concentraciones predefinidas
		Formazina propia usuario	Selecciona el estándar de formazina preparado por el usuario en concentraciones predefinidas
	Juego de estándares	Predeterminado	Se utiliza si no se establece un identificador único.
		Único	Identificador único del conjunto de estándares.
	Recordatorio¹⁾	Activar	Recuerda al usuario que la calibración está pendiente. Opción para forzar la calibración antes de que se realicen mediciones adicionales.
		Apagado	Configuración por defecto.
	Calibración predeterminada		Opción para volver al ajuste de calibración de fábrica.

	Verif. Posterior	Activar	Requiere que el usuario realice una Verificación después de completar la calibración.
		Apagado	Configuración por defecto.
	Calificador de cal	Activar (Predeterminado)	Durante el procedimiento de calibración, si un estándar individual está fuera de la tolerancia, el usuario debe corregir el estándar para continuar o cancelar el procedimiento de calibración. Esta función evita que el usuario cometa un error de calibración debido a un estándar incorrecto. La pantalla de registro tendrá un elemento de línea para el Verificador de Calibración y mostrará un estado "Activado" o "Habilitado".
		Apagado	Durante el procedimiento de calibración, si un estándar individual está fuera de la tolerancia, el usuario no será notificado de que un calibrador está fuera del rango predefinido de los Tintómetros. La pantalla de registro tendrá un elemento de línea para el Comprobador de Calibración y mostrará un estado "Desactivado" o "Inhabilitado".

ES

¹⁾ no TB350

4.6 Verification

4.6.1 Resumen de la verificación

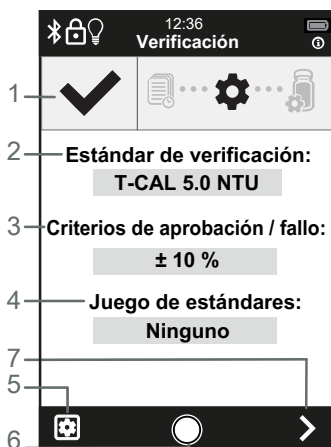

Descripción	Función
1 Barra de aplicaciones	Ruta de navegación para ayudar al usuario en los pasos del proceso.
2 Norma de verificación	Valor del Estándar a medir.
3 Criterios de aprobación/fallo	Tolerancia utilizada para determinar si una verificación pasa o falla.
4 Juego de estándares	Identificador único del conjunto de estándares.
5 Botón "Configuración"	Sirve para cambiar los ajustes.
6 Botón "Home" (Inicio)	Devuelve al usuario a la pantalla de inicio.
7 Botón "Siguiente"	Avanza a la siguiente pantalla.

ES

4.6.2 Realización de una verificación

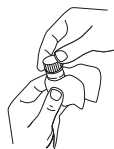

1. Prepare la cubeta:

Cubeta de muestra de aceite si es necesario.



3. Insertar estándar:

Inserta el valor estándar especificado en la pantalla.



4. Modal:

Representa el proceso activo.



5. Resumen del registro:

Pulse el botón Guardar para guardar el registro.

Pulse el botón Cancelar para volver al principio del proceso de verificación.

4.6.3 Configuración de la verificación



Pulse el botón de configuración para entrar en el modo de configuración.

Icono	Descripción	Opción	Función
	Estándar	T-CAL 5.0 NTU	Selecciona el estándar de formazina estabilizado preparado a una concentración de 5,0 NTU.
		Usuario preparado	Selecciona el estándar preparado por el usuario entre 1 y 1000 NTU.
	Criterios de Pass/Fail	±10%	Tolerancia utilizada para determinar si una verificación pasa o falla.
		± 5%	
		±0.05 NTU	
		±0.10 NTU	
	Recordatorio ¹⁾	en	Recuerda al usuario que la verificación está pendiente.
		apagado	Configuración por defecto.

¹⁾ no TB350

4.7 Registros

4.7.1 Seleccionar un tipo de registro



Pulse el botón de tipo de registro en el área de acción para acceder a los registros.

Barra de aplicación:



Registros de medición:

Muestra todas las mediciones registradas.



Registros de Calibración:

Muestra todos los registros de calibración.



Registros de verificación:
Muestra todos los registros de verificación.



Registros del modo GLP:
Muestra el registro del modo GLP activado o desactivado.

¹⁾ no TB 350

ES

4.7.2 Recuperar un registro



1. Seleccionar tipo de registro

Muestra los registros del tipo de registro que el usuario desea ver.



2. Exportar registros individuales

Si se selecciona un solo registro, éste se exporta en formato CSV.
Se exportan todos los detalles asociados al registro.



3. seleccione el método de transferencia

USB: Exporta el protocolo a una memoria USB.



Bluetooth^{® 1)}: Exporta el registro a la aplicación móvil AquaLX.

No disponible en el TB 350.

Nota: se requiere un dongle externo Lovibond[®] Bluetooth[®] para la conexión al puerto USB-A.

¹⁾ no TB 350

4.8 Ajustes del instrumento



Pulse el botón de configuración para acceder al modo de configuración.

Icono	Descripción	Opción	Función
	Seguridad	Habilitar	Configurar, verificar y cambiar la contraseña.
		Desactivar	Configuración por defecto.



Configuraciones de energía

Brillo de la pantalla	Ajustar el brillo de la pantalla.
Deshabilitar luz de fondo	apagado 20 segundos 30 segundos 1 minuto* 5 minutos
Apagado del sistema	apagado 1 minuto 2 minutos 5 minutos 15 minutos* Nota: Cuando se utiliza el cable de alimentación USB-C, el apagado del sistema se establece en "Off" hasta que se desenchufa la unidad y luego vuelve a la opción seleccionada.



Bluetooth¹⁾

Habilitar	Activa el Bluetooth® cuando el hardware está presente.
Desactivar	Configuración por defecto.

Atajos USB¹⁾ Habilitar

Si se activa, cuando se conecta un dispositivo de almacenamiento USB, el usuario se encuentra con un modal que presenta una opción para la "transferencia de registros" o la configuración de "copia de seguridad/restauración". Al seleccionar una opción, el usuario es dirigido a la función apropiada.

 Desactivar

Configuración por defecto; los usuarios deben acceder a la configuración de "Registros" o "Copia de seguridad/restauración" cuando el dispositivo de almacenamiento USB está conectado.

Idioma

Selecciona el idioma.

Fecha/hora

Seleccione la hora mostrada y el formato.

Copia de seguridad/restauración

Copia de seguridad de todas las configuraciones¹⁾

Opción de guardar los ajustes en la tarjeta SD local o en una unidad USB externa.

 Restaurar toda la configuración¹⁾

Recupera los ajustes almacenados previamente en la tarjeta SD local o en una unidad USB externa.

 Restaurar a configuración de fábrica

Restablece todos los ajustes a los valores de fábrica. Los registros guardados siguen estando disponibles.



Tipo de unidad

NTU	Seleccione la unidad mostrada.
FNU	Define el tipo de unidad del valor de medición mostrado.
mg/L Kaolin	NTU es el ajuste por defecto.
mg/L PSL	
Grados	
mNTU ¹⁾	
mFNU ¹⁾	
Personalizado ¹⁾	Permitir el tipo de unidad definida por el usuario y la capacidad de establecer un factor basado en los valores NTU/FNU.



GLP¹⁾

Habilitar	Establece un protocolo de integridad de los datos para los laboratorios que siguen las buenas prácticas de laboratorio.
Desactivar	Configuración por defecto.



Propietario

Datos de contacto del propietario del instrumento.



Contáctenos

Información de contacto de las oficinas de Lovibond®.



Acerca de

Acerca de Lovibond®.

¹⁾ no TB 350

* Configuración por defecto

5 Mantenimiento

5.1 Programa de mantenimiento de reanudo

Tarea	Hacer	No hacer
1. Limpiar la cámara de medición	1. Asegúrese de que la cámara de medición esté limpia y seca antes de la medición. Utilice un paño de microfibra seco para eliminar las impurezas.	1. Rocíe o vierta cualquier líquido directamente en la cámara de medición.
2. Limpieza de la pantalla del instrumento	2. Limpie la pantalla táctil con un paño de microfibra seco o ligeramente húmedo.	2. Medir una muestra que no esté bien tapada.
Limpieza de la carcasa exterior	Limpie la carcasa exterior con una solución limpiadora suave o con alcohol diluido.	
Almacenamiento y cuidado de las cubetas de muestra	Almacenamiento y cuidado de las cubetas de muestra	Use aceite de silicona en exceso que no se haya limpiado del vial. Una sola gota es todo lo que se necesita.
	Llenar el vial con agua desionizada. Tapar el vial para evitar la formación de manchas de agua.	Dejar las células de la muestra sin tapar para que se sequen al aire.
	Secar el exterior del vial con un paño de microfibra.	Utilice cualquier frasco que tenga imperfecciones visibles, incluyendo picaduras, arañazos o grietas.
Cambio de baterías	Se sugiere retirar las pilas si el instrumento se almacena durante más de 30 días para evitar fugas en las pilas.	Utilice un tipo de batería no especificado.

Tarea	Hacer	No hacer
Calibración	<p>Calibre según sea necesario bajo las siguientes condiciones:</p> <ol style="list-style-type: none"> 1. Fallo de verificación. 2. Se realiza el mantenimiento de los sistemas ópticos o electrónicos. 3. Según lo requieran las autoridades reguladoras regionales. 	Utilizar estándares caducados.
	Siga cuidadosamente las instrucciones de preparación y uso de los estándares.	
Verificación	<p>Verifique el rendimiento del instrumento bajo las siguientes condiciones:</p> <ol style="list-style-type: none"> 1. Después de realizar una calibración. 2. Según los procedimientos internos de control de calidad. 3. Según lo exigido por las autoridades reguladoras regionales. 	Utilizar estándares caducados.
	Siga cuidadosamente las instrucciones de preparación y uso de los estándares.	
Conector / Cierre	Asegúrese de que la junta del conector esté colocada cuando no esté en un entorno de laboratorio.	<p>No almacene la unidad sin la junta conectada.</p> <p>Transporte o soporte del instrumento a través de un cable conector.</p>



¡Atención!

La manipulación incorrecta de ciertos reactivos puede dañar su salud. En cualquier caso, siga la información de las etiquetas de seguridad del envase, las instrucciones de seguridad del prospecto y la hoja de datos de seguridad disponible. Las medidas de protección allí especificadas deben seguirse con exactitud.

6 Resolución de problemas

6.1 Mensajes de error y qué hacer

Síntoma	Posible causa	Solución
Rango elev.	La turbidez de la muestra está más allá del rango de medición del instrumento.	<ul style="list-style-type: none"> Diluir la muestra Verificar la calibración utilizando un estándar de alto rango.
Rango bajo	La turbidez de la muestra está por debajo del límite de detección del instrumento.	<ul style="list-style-type: none"> Repita la medición de la luz difusa (ajuste del cero) según lo prescrito y asegúrese de que la tapa de la muestra esté cerrada. Repita la calibración después de determinar la luz difusa.
El instrumento no se enciende	Las pilas están defectuosas Las pilas no están bien colocadas	<ul style="list-style-type: none"> Sustituya las pilas por un juego completo nuevo.
El botón "Guardar" de una función no aparece, por lo que no se puede crear un registro.	Falta la información requerida	Asegúrese de que las iniciales del usuario y todos los demás campos obligatorios están correctamente dirigidos.
El instrumento no realiza la medición	La tapa no está cerrada	Cerrar la tapa.
Notificación de batería baja	La batería está por debajo del 20%.	Sustituya o recargue las pilas.
El usuario no puede acceder a los ajustes del instrumento	El protocolo de seguridad del dispositivo está activo	Introduzca la contraseña para desbloquear las funciones de Configuración y Calibración.
Error de calibración	Los viales de las muestras no se limpiaron antes de la calibración.	<ul style="list-style-type: none"> Vuelva a lavar los viales de muestra siguiendo el procedimiento indicado en el manual. Almacene los viales como se indica en el manual. Comprobar la fecha de caducidad del estándar
Error de calibración	Los estándares de calibración se ejecutaron en el orden equivocado.	Repita la calibración con los estándares de menor a mayor valor.

Síntoma	Posible causa	Solución
Error de calibración	Los estándares de calibración no se mezclaron adecuadamente.	Mezcle los estándares según las instrucciones inmediatamente antes de realizar la calibración.
Error de calibración	Estándares de calibración preparados para valores de turbidez erróneos.	Repita la preparación de los estándares de calibración, asegurándose de que las diluciones son correctas.
Error de verificación	La verificación queda fuera de los límites del Error.	<ul style="list-style-type: none"> • Mezclar el estándar de verificación antes de la verificación. • Compruebe los criterios de aprobación/desaprobación para asegurarse de que los criterios no son más estrictos que la precisión del estándar y ajuste estos criterios en consecuencia. • Comprobar la fecha de caducidad del estándar

7 Accesorios y piezas de repuesto

7.1 Lista de accesorios

Título		Referencia No
Aceite de silicona	TB350 IR, TB350 WL	194295
Cable USB-C de 1 m, USB-C a A	TB350 IR, TB350 WL	19820-081
Cepillo, 11 cm longitud	TB350 IR, TB350 WL	380230
Cubetas de medición con tapa, altura 55 mm, ø 24 mm, juego de 12	TB350 IR, TB350 WL	197655
Fuente de alimentación TB series	TB350 IR, TB350 WL	19820-170
Juego estándares de turbidez T-CAL (5, 20, 800, 2000, 4000 NTU)	TB350 WL	194152
Juego estándares de turbidez T-CAL (5, 20, 800, 4000 NTU)	TB350 IR	194154
Paño de limpieza	TB350 IR, TB350 WL	197635
Paquete de 3 pilas, HR6, AA, Ni-MH	TB350 IR, TB350 WL	19820-011
Pilas (AA), juego de 4	TB350 IR, TB350 WL	1950025
Soporte para cubetas para 6 cubetas redondas ø 24 mm	TB350 IR, TB350 WL	418951
T-CAL®-Standard, 4000 NTU, 125 ml	TB350 IR, TB350 WL	48012912
T-CAL®-Standard, 4000 NTU, 500 ml	TB350 IR, TB350 WL	48012950

7.2 Lista de accesorios

Descripción	Número de pieza
Maletín de transporte	19820-130
Tapa, cámara de muestras	19820-095
Tapa, compartimento de la batería	19820-098
Enchufe, elastomérico, IP67, I/O	19820-084
Inserto para 4 pilas AA	19820-012

8 Especificaciones

Model	Model WM-040-1004 (IR) Model WM-040-1001 (WL)
Fuente luminosa	LED infrarrojo (860 nm) LED blanco
Cumplimiento regulaciones	ISO 7027 Aprobado por la EPA (alternativa a la US EPA 180.1)
Principio de medición	Nefelométrica (Multipath 90° BLAC)
Rango de medición	0,01 - 4000 NTU (FNU)
Resolución	Autoranging: 0.01-9.99: 0.01 NTU ; 10.0-99.9: 0.1 NTU ; 100-4000: 1 NTU
Precisión	± 1,8 % de la lectura + luz difusa
Repetibilidad	< 1 % o ± 0,01 NTU
Luz parásita	< 0.014 NTU
Unidad mostrada	NTU, FNU, grados, mg/L de caolín, mg/L PSL
Tiempo de respuesta	7 segundos
Modos de lectura	Soltero, Promedio de señal, Fast-Settling
Opciones de calibración	Calibración de rango completo de 0 - 4000 NTU
Detector	Fotodiodo de silicio
Modo de ratio	Sí
Volumen de muestra requerido	10 mL (0,4 oz)
Display	Pantalla táctil a todo color
Tamaño de la pantalla	55 x 95 mm (A x A)
Interfaces	<ul style="list-style-type: none"> • USB-A • USB-C
Datalogger	250 mediciones, todas las calibraciones, verificaciones y restauraciones en fábrica
Formato transmisión de datos	.csv
Modo de ahorro de energía	Sí

Auto – OFF	Seleccionable
Alimentación eléctrica	<ul style="list-style-type: none"> • 3 NiMH-battery pack (AA) • 4 batteries (AA) • Universal (90 - 240 VAC), via external power supply
Condiciones ambientales	Temperatura: 0 - 50 °C (32 - 122 °F) Humedad: 0 - 90 % a 30 °C, sin condensación Humedad: 0 - 80 % a 40 °C (104 °F), sin condensación Humedad: 0 - 70 % a 60 °C, sin condensación
Clase de protección	IP 67 (instrumento)
Conformidad	<ul style="list-style-type: none"> • CE • CSA • FCC A • RoHS • TÜV • UL • WEE
Idiomas Interfaz de usuario	<ul style="list-style-type: none"> • Alemán • Chino • Español • Francés • Holandés • Inglés • Japonés • Polaco • Portugués • Turco
Guía de inicio rápido de los idiomas	<ul style="list-style-type: none"> • Alemán • Chino • Español • Francés • Holandés • Inglés • Italiano • Portugués • Ruso • Turco

Idiomas Manual de usuario completo	<ul style="list-style-type: none"> • Alemán • Chino • Español • Francés • Holandés • Inglés • Italiano • Portugués • Ruso • Turco
Medidas	155 x 83 x 225 mm
Peso	804 g (898 g with four AA alkaline batteries)
Peso con embalaje	(898 g with four AA alkaline batteries)



¡Precaución!

Sujeto a modificaciones técnicas.
Para garantizar la máxima precisión de los resultados de las pruebas, utilice siempre los sistemas de reactivos suministrados por el fabricante del instrumento.

8.1 Especificaciones - Adaptador de red

Tipo	WR9QA2500USB52NMR6B
Diseño	Enchufe del adaptador de red, fuente de alimentación conmutada
Tensión de entrada, frecuencia	100 – 240 V \pm 10 %, 50 / 60 Hz \pm 5 %
Corriente de entrada	0.3 A
Adaptador principal	Europa, Reino Unido, Australia, Estados Unidos
Clase de protección	II
Tensión de salida, frecuencia	5.2 V, DC
Corriente de salida máxima	2.5 A
Protección de la salida	Apagado de salida y reinicio automático
Condiciones ambientales	De 0 °C a 40 °C, con un máximo de 95 % de humedad relativa del aire
Clase de eficiencia energética	VI
Norma de seguridad	EN 62368

Tipo	WR9QA2500USB52NMR6B
EMC	EN 55032 FCC Part 15 Clase A EN 55024
Dimensiones [mm]	31.5 x 41 x 71 (sin adaptador primario)
Peso, con adaptador UE	48 g (sin adaptador primario)
Aprobación, EMC	CE, FCC
Altitud permitida metros	5000 m
Nivel de polución	2



¡Precaución!

Sujeto a modificaciones técnicas.
Para garantizar la máxima precisión de los resultados de las pruebas, utilice siempre los sistemas de reactivos suministrados por el fabricante del instrumento.

9 Apéndice

9.1 Aviso de derechos de autor y marcas comerciales

Lovibond®, Tintometer® y T-CAL® son marcas registradas del grupo de empresas Tintometer. Todas las traducciones y transliteraciones de Lovibond® y Tintometer® se afirman como marcas comerciales del grupo Tintometer®.

La marca Bluetooth®, la marca de la figura y la marca combinada son marcas comerciales propiedad de Bluetooth SIG y cualquier uso por parte del Grupo Tintometer® es bajo licencia.

Table des matières

	Page
1 Introduction	124
1.1 Informations générales	124
1.1.1 Lire les instructions avant l'utilisation	124
1.1.2 Objet du produit	124
1.1.3 Utilisation autorisée	124
1.1.4 Exigences pour une utilisation sûre	124
1.1.5 Gardez les instructions	125
1.1.6 Qualification des utilisateurs	125
1.1.7 Manipulation de produits chimiques dangereux	125
1.1.8 Instructions pour la disposition du produit	125
1.2 Liste de tous les caractères utilisés dans le document	126
1.3 Abréviations	126
2 Aperçu du produit	127
2.1 Certification	127
2.2 Fonctionnalités	128
2.3 Description du produit	128
2.4 Vue des instruments	128
3 Mise en service	130
3.1 Environnement opérationnel	130
3.2 Contenu de la livraison	130
3.3 Insertion et remplacement des piles	131
4 Opération	133
4.1 Premier démarrage	133
4.2 Principes généraux de fonctionnement	134
4.3 Liste des éléments de contrôle et leur fonction	135
4.3.1 Aperçu de l'affichage	135
4.3.2 Liste des éléments de contrôle et leur fonction	136
4.3.3 Barre d'état	138
4.4 La mesure	139
4.4.1 Aperçu des mesures	139
4.4.2 Exécution d'une mesure	140
4.4.3 Conseils de mesure	141
4.4.4 Réglages des mesures	142
4.5 Étalonnage	143
4.5.1 Aperçu de l'étalonnage	143
4.5.2 Effectuer un étalonnage	143
4.5.3 Réglages de l'étalonnage	144

	Page
4.6 Vérification	145
4.6.1 Vérification - Aperçu	145
4.6.2 Effectuer une vérification	146
4.6.3 Paramètres de vérification	147
4.7 Enregistrements	147
4.7.1 Sélection d'un type de journal	147
4.7.2 Récupération d'un journal	148
4.8 Paramètres de l'instrument	148
5 Maintenance	153
5.1 Programme d'entretien recommandé	153
6 Dépannage	155
6.1 Messages d'erreur et mesures à prendre	155
7 Accessoires et pièces de rechange	157
7.1 Liste des accessoires	157
7.2 Pièces de rechange	158
8 Spécifications	159
8.1 Spécifications - Adaptateur secteur	161
9 Appendice	163
9.1 Avis sur les droits d'auteur et les marques de commerce	163

1 Introduction

1.1 Informations générales

1.1.1 Lire les instructions avant l'utilisation

Ce manuel fournit des informations importantes sur un fonctionnement adéquat du produit en toute sécurité. Veuillez lire attentivement ce manuel et vous familiariser avec le produit avant de l'utiliser.

FR

1.1.2 Objet du produit

Le turbidimètre portable de la série TB est conçu pour analyser des échantillons aqueux qui sont recueillis dans des cuvettes en verre puis scellés. La cuvette est préparée pour la mesure en utilisant une technique minutieuse pour minimiser les interférences de la poussière et des rayures. Après la préparation, la cuvette est placée dans l'instrument pour la mesure.

L'instrument peut être utilisé en laboratoire ou emmené sur le terrain pour effectuer des mesures sur des échantillons au fur et à mesure de leur collecte.

Il convient d'être prudent lors du transport de ce turbidimètre. Si l'instrument est emporté sur le terrain, il faut utiliser la mallette de transport. Si l'instrument doit être utilisé pour des applications réglementaires, il est conseillé de contacter les autorités locales pour s'assurer que le modèle d'instrument correct est sélectionné.

1.1.3 Utilisation autorisée

La responsabilité et la garantie du fabricant pour les dommages sont annulées en cas d'utilisation inappropriée, de non-respect de ce manuel, d'utilisation par du personnel non qualifié ou de modifications non autorisées du produit.

Le fabricant n'est pas responsable des coûts ou des dommages causés par l'utilisateur ou des tiers en raison de l'utilisation de ce produit, en particulier en cas d'utilisation inappropriée du produit ou de mauvaise utilisation, de défauts de connexion du produit. Le fabricant n'assume aucune responsabilité pour les erreurs d'impression.

1.1.4 Exigences pour une utilisation sûre

Notez les points suivants pour une utilisation qui soit sûre de l'appareil :

- Si l'appareil est utilisé d'une façon qui n'est pas spécifiée par le fabricant, la protection assurée par l'appareil peut être compromise.
- Le produit ne doit être utilisé que conformément à l'utilisation autorisée spécifiée ci-dessus.
- Le produit doit être alimenté uniquement par les sources d'alimentation mentionnées dans ce manuel d'utilisation.
- Le produit ne doit être utilisé que dans les conditions environnementales mentionnées dans ce manuel d'utilisation.
- Le produit ne doit pas être ouvert ou modifié.

Le produit ne doit pas être utilisé si :

- il est visiblement endommagé (par exemple, après avoir été transporté)
- il a été stocké dans des conditions défavorables pendant une longue période (conditions de stockage, voir chapitre "Spécifications")

Conditions pour une utilisation sûre du bloc d'alimentation

Respectez les points suivants pour une utilisation en toute sécurité :

- Avant la mise en service, vérifier l'absence de dommages visibles. En cas de dommage, ne pas mettre en service.
- Utiliser uniquement dans des locaux secs.
- Ne manipuler qu'avec des mains sèches.
- Seule l'alimentation recommandée par le fabricant peut être utilisée.
- Le produit ne doit pas être ouvert ou modifié.
- Seul le câble USB-C recommandé par le fabricant peut être utilisé pour alimenter l'appareil.

FR

1.1.5 Gardez les instructions

Le manuel doit être conservé à proximité du produit afin que vous puissiez toujours trouver les informations dont vous avez besoin.

1.1.6 Qualification des utilisateurs

Le personnel d'exploitation doit être capable de comprendre et d'appliquer correctement les étiquettes et les consignes de sécurité figurant sur les emballages et les notices des produits.

L'utilisateur doit être capable, apte à lire et comprendre ce manuel afin de se familiariser avec la manipulation et d'assurer une utilisation sûre.

1.1.7 Manipulation de produits chimiques dangereux

Des risques chimiques et/ou biologiques peuvent exister là où ce produit est utilisé. Respectez toutes les lois, réglementations et protocoles en vigueur lors de l'utilisation de ce produit.

Pour le développement de ses produits, Lovibond accorde une attention particulière à la sécurité. Certains risques liés à des substances dangereuses ne peuvent être évités. En cas d'utilisation de tests ou de solutions produits par l'entreprise elle-même, la responsabilité de tout risque causé par ces tests ou solutions incombe à l'utilisateur (responsabilité personnelle).

Pour votre propre protection, pour les normes de turbidité supérieures à 5 NTU, le port de gants ou de lunettes de protection est recommandé. Respectez la fiche de données de sécurité correspondante.

Les fiches de données de sécurité des produits chimiques comprennent toutes les instructions relatives à la sécurité de la manipulation, aux risques encourus, aux actions préventives et aux mesures à prendre dans les situations dangereuses.

1.1.8 Instructions pour la disposition du produit

Mettez les batteries et l'équipement électrique au rebut dans une installation appropriée, conformément à la législation locale.

Il est illégal de jeter les piles avec les déchets ménagers.

Au sein de l'Union européenne, à la fin de la vie de l'appareil, les piles sont éliminées dans un point de collecte de recyclage spécialisé.



Les instruments marqués de ce symbole ne doivent pas être jetés avec les déchets domestiques normaux.

FR

1.2 Liste de tous les caractères utilisés dans le document

Les symboles suivants sont utilisés dans ce manuel pour indiquer les sections qui nécessitent une attention particulière :



Danger!

Il existe un danger qui entraînera la mort ou des blessures graves s'il n'est pas évité !



Avertissement !

La manipulation incorrecte de certains réactifs peut nuire à votre santé. Dans tous les cas, suivez les informations figurant sur les étiquettes de sécurité de l'emballage, les consignes de sécurité de la notice et la fiche de données de sécurité disponible. Les mesures de protection qui y sont spécifiées doivent être suivies à la lettre.



Attention!

Il existe un danger qui peut entraîner des blessures mineures ou modérées.

1.3 Abréviations

Abréviations	Définition
NTU	Nephelometric Turbidity Unit
FNU	Formazin Nephelometric Units
mg/l	Milligramme par litre

2 Aperçu du produit

2.1 Certification

EMC Émissions conduites et rayonnées	CISPR 11 (Limites de la classe A)	Marque CE
Immunité EMC	EN 61326-1 (Limites industrielles)	Marque CE
Sécurité	EN 61010-1	Marque de sécurité TÜV
FCC	FCC Classe A	Marque FCC

Avis de la FCC Classe A

Cet appareil est conforme à la partie 15 des règles de la FCC. Son fonctionnement est soumis aux deux conditions suivantes :

- Cet appareil ne doit pas causer d'interférences nuisibles.
- Cet appareil doit accepter toute interférence reçue, y compris les interférences susceptibles de provoquer un fonctionnement indésirable.

Remarque : Cet équipement a été testé et déclaré conforme aux limites d'un appareil numérique de classe A, conformément à la partie 15 des règles de la FCC. Ces limites sont conçues pour fournir une protection raisonnable contre les interférences nuisibles lorsque l'équipement est utilisé dans un environnement commercial. Cet équipement génère, utilise et peut émettre de l'énergie de fréquence radio et, s'il n'est pas installé et utilisé conformément au manuel d'instructions, peut causer des interférences nuisibles aux communications radio. L'utilisation de cet équipement dans une zone résidentielle est susceptible de provoquer des interférences nuisibles, auquel cas l'utilisateur devra corriger ces interférences à ses frais.

Câbles blindés



Les connexions entre le système et ses périphériques doivent être effectuées à l'aide de câbles blindés afin de maintenir la conformité aux limites d'émission de fréquences radio de la FCC.

Attention!

Modifications



Toute modification apportée à cet appareil qui n'est pas approuvée par l'Intomètre peut annuler l'autorisation accordée à l'utilisateur par la FCC d'utiliser cet équipement.

Attention!

DOC Class A Notice - Avis DOC, Class A

Cet appareil numérique de classe A satisfait à toutes les exigences de la norme canadienne sur les interférences.

2.2 Fonctionnalités**La précision du laboratoire et la portabilité**

La série Lovibond® TB élimine les complexités de la mesure de la turbidité. Cette nouvelle technologie offre le plus haut niveau de précision et d'efficacité opérationnelle et réglementaire.

- Interface à écran tactile pour une utilisation facile
- Des instructions illustrées pour guider l'utilisateur dans les étapes du processus et éviter les erreurs.
- Des protocoles simples de gestion des données pour garantir leur intégrité

2.3 Description du produit

La turbidité est une expression des propriétés optiques d'un échantillon qui fait que les rayons lumineux sont dispersés et absorbés plutôt que transmis en ligne droite à travers un échantillon fluide. Dans l'eau, la turbidité est souvent causée par la présence de matières telles que l'argile, le limon, la matière organique finement divisée, le plancton, d'autres organismes microscopiques, les acides organiques et les pigments. La mesure de la turbidité est utilisée pour surveiller les processus qui éliminent ou modifient les concentrations de particules dans les solutions, comme dans la production d'eau potable. Ces turbidimètres Lovibond® sont conçus pour combiner la haute précision et la haute sensibilité que l'on attend d'un turbidimètre de laboratoire avec la portabilité.

2.4 Vue des instruments

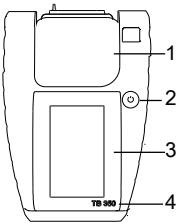
Position	Description	Fonction
	1. Couvercle	Lorsqu'il est soulevé, il permet à l'utilisateur de placer la cellule d'échantillon dans l'instrument pour une lecture.
	2. Bouton d'alimentation	Met l'instrument sous tension et hors tension.
	3. Écran tactile	Affiche l'interface utilisateur de l'instrument.
	4. Modèle	Identifie la version de l'instrument.

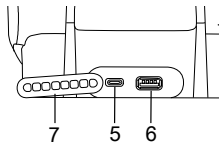
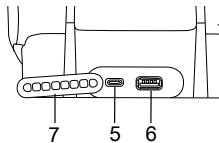
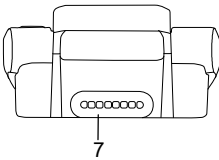
Position	Description	Fonction
	5. Port USB-C	Permet d'alimenter l'instrument à partir d'une source externe ou de recharger la batterie accessoire (si elle est installée).
	6. Port USB-A	Prend en charge un périphérique USB-A externe pour des fonctions telles que le transfert de données ou les sauvegardes.
	7. Joint	Utilisé pour couvrir les ports USB lorsque les connexions ne sont pas utilisées.

3 Mise en service

3.1 Environnement opérationnel

L'instrument peut être utilisé dans tout environnement intérieur ou extérieur jugé sûr pour qu'un opérateur puisse effectuer l'analyse.

L'instrument peut accepter des échantillons aqueux de 0 à 70 °C.

L'instrument doit être à niveau $\pm 15^\circ$ lorsqu'il effectue une mesure.

L'instrument doit être placé sur une surface plane pour obtenir les meilleures performances de mesure.

FR

3.2 Contenu de la livraison

Inspectez soigneusement tous les articles pour vous assurer que chaque partie de la liste ci-dessous est présente et qu'aucun dommage visible n'est survenu pendant l'expédition. S'il y a des dommages ou si quelque chose manque, veuillez contacter immédiatement votre distributeur local.

TB	350 IR	350 WL
Instrument	X	X
Huile de silicone, 15 ml	X	X
Tissu en microfibre	X	X
2 x cuvettes d'échantillon	X	X
Tournevis	X	X
Brosse	X	X
Mallette avec insert	X	X
Guide rapide	X	X
Déclaration de conformité	X	X
Déclaration de garantie	X	X
4 piles AA	X	X
Bloc de piles rechargeables		
Câble USB-C		
Unité d'alimentation en courant alternatif		
Adaptateur pour les prises américaines, britanniques et européennes		
T-CAL® Standard, 5 NTU	X	X
T-CAL® Standard, 20 NTU	X	X
T-CAL® Standard, 800 NTU	X	X
T-CAL® Standard, 2000 NTU		X
T-CAL® Standard, 4000 NTU	X	X

3.3 Insertion et remplacement des piles

Lors de l'utilisation de piles

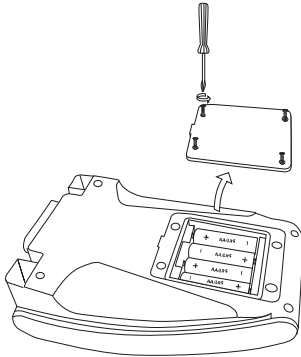

Étape	Description
1	À l'aide d'un tournevis, retirez les quatre vis situées à l'arrière de l'instrument et retirez le panneau.
2	Insérez quatre piles AA en les orientant correctement.
3	Remettez le panneau en place sur l'instrument.



Attention !

- N'utilisez que le type homologué : pile alcaline au manganèse, LR6, avec une tension de 1,5 V.
- Retirez les piles vides de l'appareil dès que possible.
- Si l'appareil n'est pas utilisé pendant une longue période, retirez les piles de l'appareil.

En cas d'utilisation des blocs des piles rechargeable

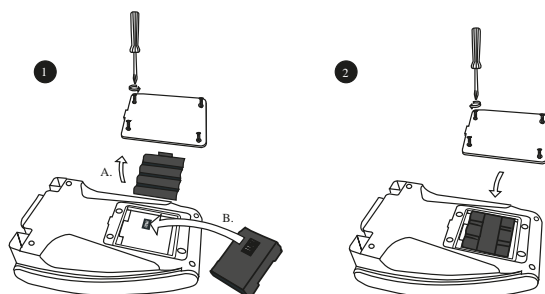

FR

Étape	Description
1	À l'aide d'un tournevis, retirez les quatre vis situées à l'arrière de l'instrument, puis retirez le panneau et le bac à piles.
2	Insérez le bloc de piles rechargeables dans le bon sens.
3	Remettez le panneau en place sur l'instrument.



Avertissement !

Le bloc de piles rechargeable (19820-011) n'est compatible qu'avec les instruments portant le numéro de série 23041000 et plus.

L'utilisation de la batterie pour des instruments dont le numéro de série est antérieur à 23041000 peut entraîner une surchauffe de l'appareil pendant la charge.

Cette surchauffe peut entraîner des lectures incorrectes et endommager l'appareil et doit donc être évitée.

Pour les instruments dont le numéro de série est inférieur à 23041000, veuillez contacter Lovibond® pour obtenir des détails sur l'utilisation de cet accessoire.

4 Opération

4.1 Premier démarrage



1. Écran de bienvenue

Écran initial que l'utilisateur voit lors de la première mise sous tension.
Appuyez sur le bouton >



2. Sélectionner la langue

Sélectionnez la langue souhaitée pour le réglage.
Appuyez sur la touche >



3. Régler la date et l'heure

Choisissez entre le format 12 et 24 heures.
Modifier les valeurs à l'aide des flèches haut et bas.
Appuyez sur la touche >



4. Mot de passe

Définissez un mot de passe choisi par l'utilisateur pour mettre en œuvre les fonctions de sécurité de l'instrument.
Appuyez sur le bouton de sauvegarde.
Si aucun mot de passe n'est souhaité, sélectionnez "Sauter".
Appuyez sur la touche >



5. Unités par défaut

Sélectionnez le type d'unité désiré pour définir.
Appuyez sur la touche >



6. Détails du contact

Saisissez les informations relatives au propriétaire de l'instrument.
Appuyez sur le bouton de sauvegarde.
Si aucun détail n'est souhaité, sélectionnez "Sauter".
Appuyez sur la touche >



7. Écran récapitulatif

Révision de la configuration initiale.
Appuyez sur < pour modifier les paramètres avant de poursuivre.
Appuyez sur > pour passer à l'écran d'accueil.
L'utilisateur peut sélectionner la tâche à effectuer avec l'instrument.

4.2 Principes généraux de fonctionnement

La conception des turbidimètres portables de la série TB est décomposée en composants fonctionnels respectifs qui sont discutés en détail. Il s'agit de la source lumineuse, du piège à lumière diffusée à 90 degrés, du détecteur de lumière diffusée, de la fiole à échantillon du turbidimètre et de la façon dont ces composants clés fonctionnent ensemble pour fournir le résultat de turbidité.

FR

La configuration optique simplifiée des turbidimètres portables de la série TB.
 Cette figure montre le trajet de la lumière incidente et la vue du détecteur de lumière diffusée à 90°.

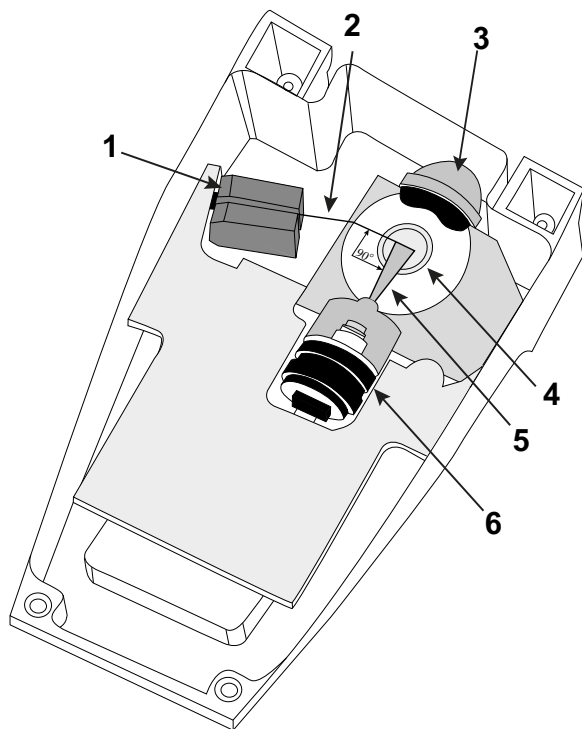





- 1 Illuminateur (LED et optique)
- 2 Trajet de la lumière incidente
- 3 Piège à lumière parasite à 90
- 4 Flaçon d'échantillon
- 5 Lumière diffusée (vue du détecteur de 10°-20°)
- 6 Détecteur de lumière diffusée et optique



4.3 Liste des éléments de contrôle et leur fonction

4.3.1 Aperçu de l'affichage











Description	Fonction
1 Barre d'état	Affiche les icônes et les étiquettes qui sont universelles, notamment Heure, Bluetooth®, USB, Sécurité, Source de lumière et Alimentation.
2 Zone d'action	Zone qui affiche les étapes de l'application et l'interaction.
3 Bouton d'accueil	Utilisé principalement pour la navigation, pour lancer ou sauvegarder ou annuler des actions et revenir à la maison.













Icône	Description
	Mode de mesure
	Mode Calibrage
	Mode Vérification
	Enregistrements de données

Icône	Description
	Connexion Bluetooth au turbidimètre de process PTV (non disponible pour TB 350)
	Paramètres de l'instrument

FR

4.3.2 Liste des éléments de contrôle et leur fonction

Icône	Description	Fonction
	Nom de l'application	Titre de l'application que l'utilisateur est en train d'utiliser.
	Temps	Heure définie par l'utilisateur lors de la configuration initiale ou en accédant aux paramètres de l'instrument. Le format 12 heures ou 24 heures est disponible.
	USB	Si elle est affichée, elle indique qu'un module USB est fixé à l'unité.
	Icône Bluetooth - simple ²⁾	Si elle est affichée, le module Bluetooth® est connecté.
	Icône Bluetooth - Avec flèches ²⁾	Si elle est affichée, le module Bluetooth® est connecté et communique activement avec un PTV ou une application AquaLX.
	Source de lumière rouge – remplie	L'instrument contient une source lumineuse LED rouge ; la lumière est allumée pour la mesure.
	Source de lumière rouge – contour	L'instrument contient une source lumineuse LED rouge ; aucune mesure n'est active.
	Source de lumière blanc – remplie	L'instrument contient une source de lumière LED blanche ; la lumière est allumée pour la mesure.
	Source de lumière blanc – contour	L'instrument contient une source de lumière LED blanche ; aucune mesure n'est active.



Icône	Description	Fonction
	Infrared Light Source – On	L'instrument contient une source de lumière LED infrarouge ; la lumière est allumée pour la mesure.
	Source de lumière infrarouge - Arrêt	L'instrument contient une source de lumière LED infrarouge ; aucune mesure n'est active.
	Source de lumière laser – remplie ¹⁾	L'instrument contient une source de lumière laser LED ; la lumière est allumée pour la mesure.
	Source de lumière laser – contour ¹⁾	L'instrument contient une source de lumière laser LED ; aucune mesure n'est active.
	Chargement de la batterie sur le CA	La batterie AC est en charge.
	Icône d'alimentation CA	Indique que l'instrument est alimenté par le courant alternatif.
	Alimentation par batterie - vert	Indique qu'il reste 100% de la durée de vie de la batterie.
	Alimentation par batterie- Jaune	Indique qu'il reste 75 % de l'autonomie de la batterie.
	Alimentation par batterie – orange	Indique qu'il reste 50 % de l'autonomie de la batterie.
	Alimentation par batterie - rouge	Indique qu'il reste 25 % de l'autonomie de la batterie.
	Couvercle de la compartiment de mesure ouvert	Indique si la couvercle de la compartiment de mesure est ouverte.
	Couvercle de la compartiment de mesure fermé	Indique si la couvercle de la compartiment de mesure est fermé.

¹⁾ uniquement TB 600

2) pas TB 350

4.3.3 Barre d'état

Icône	Description	Fonction
	Bouton d'accueil	Retourne l'utilisateur à l'écran d'accueil.
	Bouton d'accueil - Verrouillé	La sécurité est active ; le mot de passe a été activé et est nécessaire pour exécuter certaines fonctions.
	Bouton d'accueil - Déverrouillé	La sécurité est inactive ; aucune fonction n'est bloquée pour l'utilisateur.
	Bouton de sauvegarde	Sauvegarde le contenu affiché dans la zone active.
	Bouton des paramètres	Ouvre le menu de réglage d'une application.
	Bouton d'exportation	Exporte le ou les journaux affichés dans la zone active.
	Bouton de mesure	Démarré ou Commence ou Initie une mesure.
	Bouton de mesure– avec Bluetooth ⁽²⁾	Prend une mesure lorsqu'il est connecté à une unité PTV.
	Bluetooth® Bouton de rafraîchissement ⁽²⁾	Rafraîchit la liste des unités PTV disponibles à proximité de l'instrument.

Icône	Description	Function
	Bouton d'annulation	Donne l'option d'annuler l'activité en cours dans la zone active.
	Chevron droit	Passer à l'étape suivante d'un processus.
	Chevron gauche	Retourner à une étape précédente dans un processus.

²⁾ pas TB350

FR

4.4 La mesure

4.4.1 Aperçu des mesures

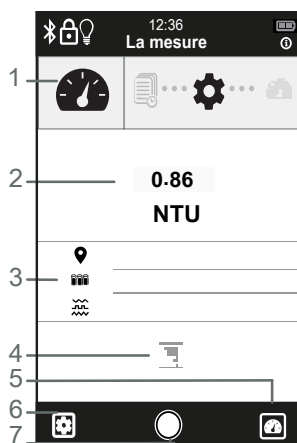

Description	Function
1 Barre d'application	Un fil d'Ariane pour aider l'utilisateur à parcourir les étapes du processus.
2 Valeur de la mesure	Affichage de la valeur mesurée de l'échantillon avec le type d'unité.
3 Paramètres	Les paramètres appliqués à la mesure sont affichés.
4 Bouton "Log" (journal)	Crée un journal lorsqu'on appuie dessus.
5 Bouton de mesure	Démarre ou Commence ou Initie une mesure lorsqu'on appuie dessus.

Description	Function
6 Bouton des paramètres	Permet de modifier les paramètres.
7 Bouton d'accueil	Retourne l'utilisateur à l'écran d'accueil.

4.4.2 Exécution d'une mesure

Veillez préparer les cellules d'échantillon incluses dans l'étendue de la livraison avant la mesure. Assurez-vous que les cellules d'échantillon sont exemptes de taches, de rayures ou d'imperfections.

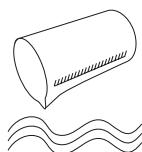

1. Prélever l'échantillon

Assurez-vous que l'échantillon est représentatif (bien mélangé). La verrerie doit être exempte de taches, de rayures ou d'autres imperfections.

Rincez le récipient de collecte au moins deux fois avec l'échantillon avant de le prélever.



2. Préparer la cuvette

À l'aide d'un chiffon non pelucheux, sécher l'extérieur de la cuvette à échantillon.

Utilisez de l'huile de silicone pour minimiser les réflexions de lumière parasite.



3. Insérer le cuvette dans l'instrument

S'assurer que l'échantillon est exempt de bulles. Inverser lentement pour mélanger. Ne pas agiter.



4. Fermer le couvercle

La mesure ne sera pas autorisée si le couvercle n'est pas en place.



5. Vérifier les réglages

Assurez-vous que les paramètres de mesure sont corrects. Les paramètres de mesure ne peuvent pas être modifiés après la prise de mesure.



6. Appuyer sur le bouton de mesure

Lance la mesure.



7. Enregistrements de données

Entrez dans "Enregistrements de données" pour enregistrer les mesures.



8. Enregistrer la mesure

Si vous le souhaitez, appuyez sur le bouton Enregistrer afin de créer un journal des mesures.



9. Pause

Suspend la mesure en mode "continu".



- Ne pas introduire d'objets dans le puits de mesure, à l'exception des cuvettes prévues pour les mesures.
- Ne pas introduire de liquides dans le puits.

Avertissement !

4.4.3 Conseils de mesure

Indexation de la cuvette : Cette opération est mieux réalisée avec une cuvette remplie d'eau filtrée à travers un filtre de 0,2 μm .

- Appuyez sur le bouton de mesure.
- Faites tourner l'échantillon. Tout en faisant tourner la cuvette, identifiez la lecture la plus basse.
- Lorsque la position est déterminée, arrêter la mesure. Marquer la cuvette.
- Avant de procéder à d'autres mesures, s'assurer que le mode de mesure est mis à jour, si nécessaire.
- Il est recommandé d'indexer la cuvette d'échantillon s'il y a une rayure ou un creux visible dans la verrerie.

Utilisation de l'huile de silicone

- Veillez à ne manipuler la cuvette que par le tiers supérieur.
- Essuyez la cuvette avec le chiffon de nettoyage fourni pour éliminer l'eau, la poussière et les traces de doigts. Huilez l'extérieur de la cuvette avec de l'huile de silicone.
 - Placez un cordon très fin d'huile de silicone sur le côté de la cuvette.
 - Répartissez uniformément le cordon d'huile sur les 2/3 du fond de la cuvette.
- Essuyez le silicone de la cuvette en faisant tourner la cuvette contre un chiffon propre et sans poussière.
- L'huilage des cellules est critique et recommandé lors de la mesure d'échantillons dont la turbidité attendue est inférieure à 0,5 NTU.

Échantillons contenant des bulles en excès

- Laisser reposer l'échantillon pendant au moins cinq minutes.
- Retourner délicatement l'échantillon deux à trois fois pour remettre en suspension la turbidité.
- Placez dans l'instrument et procédez comme indiqué.

Autres remarques

- L'utilisation de bains à ultrasons n'est pas recommandée. L'énergie ultrasonique peut modifier la distribution des particules.
- Utilisez le mode de réglage rapide pour les échantillons qui ont de fortes concentrations de sables ou de particules de haute densité.

4.4.4 Réglages des mesures

FR



Appuyez sur le bouton Paramètres pour accéder au mode Paramètres de mesure.

Icône	Description	Option	Function
	Mode	Unitaire	Appuyez pour déclencher une mesure
		Continu ¹⁾	Les mesures sont mises à jour toutes les X secondes jusqu'à leur arrêt.
		Règlements rapide	Recommandé pour les échantillons présentant des caractéristiques de décantation rapide.
	Emplacement	Défaut	Utilisé si aucun ID personnalisé n'est défini.
		Personnalisation	Description personnalisée de l'emplacement de la mesure et des limites de mesure.
	Signal moy.	Sur	Si elle est activée, elle peut être configurée jusqu'à 255 mesures. Cette fonction doit être utilisée si les mesures sont instables.
		De	Désactivé
	Identifiant de l'échantillon	Défaut	Utilisé si aucun ID personnalisé n'est défini.
		Personnalisation	Identifiant unique de l'échantillon ; sélectionnable par l'utilisateur.

¹⁾ pas TB350

4.5 Étalonnage

4.5.1 Aperçu de l'étalonnage

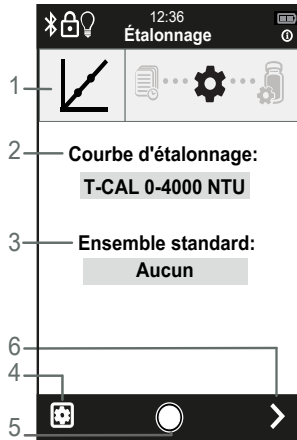

Description	Function
1 Barre d'application	Un fil d'Ariane pour aider l'utilisateur à parcourir les étapes du processus.
2 Courbe d'étalonnage	Spécifie le type d'étalonnage.
3 Ensemble standard	Identifiant unique du jeu de normes.
4 Bouton des paramètres	Permet de modifier les paramètres.
5 Bouton d'accueil	Retourne à l'écran d'accueil.
6 Bouton suivant	Passer à l'écran suivant.

4.5.2 Effectuer un étalonnage

Veillez préparer les étalons T-CAL[®] inclus dans la livraison avant l'étalonnage. Assurez-vous que les flacons T-CAL[®] sont exempts de taches, de rayures ou d'imperfections.

- Etalons T-CAL[®] pour TB 350 IR : 20 / 800 / 4000 NTU
- Etalons T-CAL[®] pour TB 350 WL : 20 / 800 / 2000 / 4000 NTU

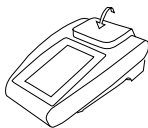

- 1. Réglage du zéro :**
Définit la norme zéro.

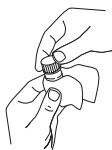
**2. Préparer la cuvette :**

Huiler la cuvette d'échantillon si nécessaire.

**3. Insérer la standard :**

Insérer la valeur standard spécifiée à l'écran.

L'utilisateur insère une série d'étalons de turbidité différents pour compléter l'étalonnage.

**4. Modale:**

Représente le processus actif.

**5. Résumé du journal :**

Appuyez sur le bouton Enregistrer pour sauvegarder le journal.



Appuyez sur le bouton Annuler pour revenir au début du processus d'étalonnage.

4.5.3 Réglages de l'étalonnage



Appuyez sur le bouton Paramètres pour accéder au mode Paramètres de mesure.

Icône	Description	Option	Fonction
	Courbe d'étalonnage	T-CAL®	Sélectionne la formazine standard stabilisée préparée à des concentrations prédéfinies.
		Utilisateur Formazin	Sélectionne la formazine standard préparée par l'utilisateur à des concentrations prédéfinies.
	Ensemble standard	Défaut	Utilisé si aucun identifiant unique n'est défini.
		Unique	Identifiant unique du set standard.
	Rappel¹⁾	Sur	Rappelle à l'utilisateur que l'étalonnage doit être effectué. Option permettant de forcer l'étalonnage avant que d'autres mesures ne soient effectuées.
		De	Réglage par défaut.
	Etalonnage par défaut		Option permettant de revenir aux paramètres d'étalonnage d'usine.

	Vérifier après	Sur	Demande à l'utilisateur d'effectuer une vérification une fois l'étalonnage terminé.
		De	Réglage par défaut.
	Vérificateur	Sur (Défaut)	Pendant la procédure d'étalonnage, si un étalon individuel est hors tolérance, l'utilisateur doit corriger l'étalon pour poursuivre ou annuler la procédure d'étalonnage. Cette fonction évite à l'utilisateur de commettre une erreur d'étalonnage en raison d'un standard incorrect. L'écran du journal comportera une ligne pour le vérificateur d'étalonnage et affichera un état "On" ou "Enabled".
		De	Pendant la procédure d'étalonnage, si un étalon individuel est hors tolérance, l'utilisateur ne sera pas averti qu'un étalonneur est hors de la plage prédéfinie des tintomètres. L'écran du journal comportera un élément de ligne pour le vérificateur d'étalonnage et il affichera un état "Off" ou "Disabled".

¹⁾ pas TB350

4.6 Vérification

4.6.1 Vérification - Aperçu

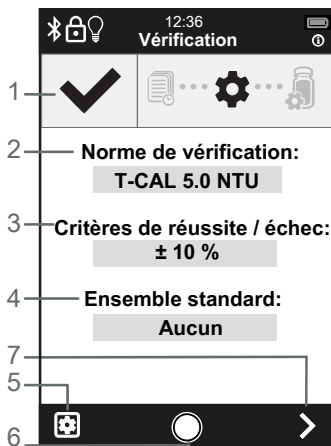

Description	Function
1 Application Bar	Un fil d'Ariane pour aider l'utilisateur à parcourir les étapes du processus.
2 Standard de vérification	Valeur du standard à mesurer.
3 Critères de réussite / échec	Tolérance utilisée pour déterminer si une vérification réussit ou échoue.
4 Ensemble standard	Identifiant unique du jeu de standards.
5 Bouton des paramètres	Permet de modifier les paramètres.
6 Bouton d'accueil	Retourne l'utilisateur à l'écran d'accueil.
7 Bouton suivant	Passer à l'écran suivant.

4.6.2 Effectuer une vérification

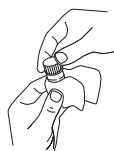

1. Préparer la cuvette :

Huiler le cuvette d'échantillon si nécessaire.



3. Insérer la standard :

Insérer la valeur standard spécifiée à l'écran.



4. Modale :

Représente le processus actif.



5. Résumé du journal :

Appuyez sur le bouton Enregistrer pour sauvegarder le journal.
Appuyez sur le bouton Annuler pour revenir au début du processus de vérification.

4.6.3 Paramètres de vérification



Appuyez sur le bouton Paramètres pour accéder au mode paramètres.

Icône	Description	Option	Fonction
	Standard	T-CAL 5.0 NTU	Sélectionne le standard de formazine stabilisé préparé à une concentration de 5,0 NTU.
		Préparé par l'utilisateur	Sélectionne la standard préparé par l'utilisateur entre 1 et 1000 NTU.
	Critères de pass/fail	±10%	Tolérance utilisée pour déterminer si une vérification réussit ou échoue.
		± 5%	
		±0.05 NTU	
		±0.10 NTU	
		Personalisation	Valeur saisie par l'utilisateur. Tolérance de ±20% ou ±0,05 - 0,2 NTU autorisée.
	Rappel¹⁾	Sur	Rappelle à l'utilisateur que la vérification est due.
		Off	Réglage par défaut.

¹⁾ pas TB350

4.7 Enregistrements

4.7.1 Sélection d'un type de journal



Appuyez sur le bouton Type de journal dans la zone d'action pour accéder aux journaux.

Barre d'application :



Journaux de mesures :

Affiche toutes les mesures enregistrées.



Journaux d'étalonnage :

Affiche tous les enregistrements d'étalonnage.



Journaux de vérification :
Affiche tous les enregistrements de vérification.



Journaux du mode GLP :
Affiche l'enregistrement de l'activation ou de la désactivation du mode GLP.

¹⁾ pas TB 350

FR

4.7.2 Récupération d'un journal



1. Sélectionner le type de journal

Affiche les enregistrements du type de journal que l'utilisateur souhaite visualiser.



2. Exporter des journaux individuels

Si un seul enregistrement est sélectionné, ce journal est exporté au format CSV.
Tous les détails associés au journal sont exportés.



3. Sélectionnez la méthode de transmission

USB : exporte le protocole vers une mémoire USB.



Bluetooth^{®1)} : Exporte le journal vers l'application mobile AquaLX.
Non disponible sur TB 350.

Note : un dongle externe Lovibond[®] Bluetooth[®] est nécessaire pour la connexion au port USB-A.



¹⁾ pas TB 350

4.8 Paramètres de l'instrument



Appuyez sur le bouton Paramètres pour accéder au mode Paramètres.

Icône	Description	Option	Function
	Sécurité	Activer	Configurer, vérifier et changer le mot de passe.
		inactivé	Réglage par défaut.

	Paramètres d'alimentation	Luminosité de l'écran	Réglez la luminosité de l'écran.
		Rétroéclairage Veille	eteint 20 secondes 30 secondes 1 minute* 5 minutes
		Arrêt du système	eteint 1 minute 2 minutes 5 minutes 15 minutes*
			Remarque : lorsque le câble d'alimentation USB-C est utilisé, l'arrêt du système est réglé sur "Arrêt" jusqu'à ce que l'appareil soit déconnecté du secteur, puis revient à l'option sélectionnée.
	Bluetooth¹⁾	Activer	Active le Bluetooth® lorsque le matériel est présent.
		inactivé	Réglage par défaut.



**Raccourcis
USB¹⁾** Activer

Si elle est activée, lorsqu'un périphérique de stockage USB est connecté, l'utilisateur voit apparaître une modale qui présente une option pour les paramètres de "transfert des journaux" ou de "sauvegarde/restauration". En sélectionnant une option, l'utilisateur est dirigé vers la fonction appropriée.

inactivé

Réglage par défaut ; les utilisateurs doivent accéder aux paramètres "Logs" ou "Backup/Restore" lorsque le périphérique de stockage USB est connecté.



Langue

Sélectionnez la langue.



Date/heure

Sélectionnez l'heure affichée et le format.



Rétablissement de sauvegarde

Sauvegarder tous les paramètres¹⁾ Possibilité d'enregistrer les paramètres sur la carte SD locale ou sur un lecteur USB externe.

Restaurer tous les paramètres¹⁾

Récupère les paramètres précédemment enregistrés sur la carte SD locale ou le lecteur USB externe.

Rétablir les paramètres d'usine

Réinitialise tous les paramètres aux valeurs d'usine par défaut. Les journaux sauvegardés sont toujours disponibles.



Type d'unité

NTU

Sélectionnez l'unité affichée.

FNU

mg/L Kaolin

mg/L PSL

Degrés

mNTU¹⁾

mFNU¹⁾

Personnalisation¹⁾

Définit le type d'unité de la valeur de mesure affichée. NTU est le paramètre par défaut.

Permet à l'utilisateur de définir un type d'unité et la possibilité de définir un facteur basé sur les valeurs NTU/FNU.



GLP¹⁾

Activer

Établit un protocole pour l'intégrité des données pour les laboratoires qui suivent les bonnes pratiques de laboratoire.

inactivé

Réglage par défaut.

**Propriétaire**

Coordonnées du propriétaire de l'instrument.

**Nous contacter**

Coordonnées des bureaux Lovibond®.

**À propos**

À propos de Lovibond®.

FR

¹⁾ pas TB 350

* Réglage par défaut

5 Maintenance

5.1 Programme d'entretien recommandé

Tâche	Faire	Ne pas faire
1. Nettoyer la chambre de mesure	1. Assurez-vous que la chambre de mesure est propre et sèche avant la mesure. Utilisez un chiffon sec en microfibres pour éliminer les impuretés.	1. Vaporisez ou versez tout liquide directement dans la chambre de mesure.
2. Nettoyer l'écran de l'instrument	2. Essuyez l'écran tactile avec un chiffon en microfibre sec ou légèrement humide.	2. Mesurez un échantillon qui n'est pas hermétiquement fermé.
Nettoyer le boîtier extérieur	Nettoyez le boîtier extérieur avec une solution détergente douce ou de l'alcool dilué.	
Stockage et entretien des cuvettes d'échantillon	Rincez toujours les cuvettes avec de l'eau non trouble après utilisation.	Utilisez l'excès d'huile de silicone qui n'a pas été essuyé du cuvette. Une seule perle suffit.
	Remplir la cuvette avec de l'eau déminéralisée. Boucher le cuvette pour éviter la formation de taches d'eau.	Laissez les cuvette de l'échantillon sans couvercle pour qu'elles sèchent à l'air libre.
	Essuyez l'extérieur du vial avec un chiffon en microfibre.	Utilisez tout cuvette qui présente des imperfections visibles, notamment des piqûres, des rayures ou des fissures.
Remplacement de la batterie	Il est conseillé de retirer les piles si l'instrument est stocké pendant plus de 30 jours afin d'éviter toute fuite des piles.	Utilisez un type de batterie non spécifié.

Tâche	Faire	Ne pas faire
Calibrage	<p>Calibrez au besoin dans les conditions suivantes :</p> <ol style="list-style-type: none"> 1. Échec de la vérification. 2. Une maintenance des systèmes optiques ou électroniques est effectuée. 3. Comme l'exigent les autorités réglementaires régionales. 	Utiliser des normes périmées.
	<p>Suivez attentivement les instructions de préparation et d'utilisation des étalons.</p>	
Vérification	<p>Vérifiez les performances de l'instrument dans les conditions suivantes :</p> <ol style="list-style-type: none"> 1. Après avoir effectué un étalonnage. 2. Selon les procédures internes de contrôle de la qualité. 3. Selon les exigences des autorités réglementaires régionales. 	Utiliser des normes périmées.
	<p>Suivez attentivement les instructions de préparation et d'utilisation des étalons.</p>	
Connecteur / Joint d'étanchéité	Assurez-vous que le joint du connecteur est fixé lorsqu'il n'est pas dans un environnement de laboratoire.	Ne stockez pas l'appareil sans le joint d'étanchéité.
		Transporter ou supporter l'instrument via un câble de connexion.

Avertissement !

La manipulation incorrecte de certains réactifs peut nuire à votre santé. Dans tous les cas, suivez les informations figurant sur les étiquettes de sécurité de l'emballage, les consignes de sécurité de la notice et la fiche de données de sécurité disponible. Les mesures de protection qui y sont spécifiées doivent être suivies à la lettre.

6 Dépannage

6.1 Messages d'erreur et mesures à prendre

Symptôme	Cause possible	Solution
Dépassement de gamme	La turbidité de l'échantillon est au-delà de la plage de mesure de l'instrument.	<ul style="list-style-type: none"> Diluer l'échantillon Vérifier l'étalonnage en utilisant un standard à haute gamme.
Sous la gamme	La turbidité de l'échantillon est inférieure à la limite de détection de l'instrument.	<ul style="list-style-type: none"> Répétez la mesure de la lumière diffusée (réglage du zéro) comme prescrit et assurez-vous que le couvercle de l'échantillon est fermé. Répétez l'étalonnage après avoir déterminé la lumière parasite.
L'instrument ne s'allume pas	Les piles sont défectueuses Les piles ne sont pas insérées correctement	<ul style="list-style-type: none"> Remplacez les piles par un jeu complet et neuf.
Le bouton "Enregistrer" d'une fonction n'apparaît pas, ce qui empêche la création d'un journal.	Les informations requises sont manquantes	Assurez-vous que les initiales de l'utilisateur et tous les autres champs obligatoires sont correctement renseignés.
L'instrument ne prend pas de mesure	Le couvercle n'est pas fermé	Fermez le couvercle.
Notification de batterie faible	La batterie est inférieure à 20%.	Remplacer ou recharger les piles
Les réglages de l'instrument ne sont pas accessibles à l'utilisateur	Le protocole de sécurité du dispositif est actif	Saisissez le mot de passe pour déverrouiller les fonctions de réglage et d'étalonnage.
Erreur d'étalonnage	Les flacons d'échantillons n'ont pas été nettoyés avant l'étalonnage.	<ul style="list-style-type: none"> Lavez à nouveau les flacons d'échantillon en suivant la procédure indiquée dans le manuel. Conservez les flacons comme indiqué dans le manuel. Vérifier la date d'expiration de la norme

Symptôme	Cause possible	Solution
Erreur d'étalonnage	Les standards d'étalonnage ont été passés dans le mauvais ordre.	Répétez l'étalonnage avec les étalons en allant de la valeur la plus basse à la plus haute.
Erreur d'étalonnage	Les standards de calibrage n'ont pas été mélangés de manière adéquate.	Mélangez les étalons comme indiqué juste avant d'effectuer l'étalonnage.
Erreur d'étalonnage	Standards d'étalonnage préparés pour des valeurs de turbidité erronées	Répétez la préparation des étalons de calibration, en vous assurant que les dilutions sont correctes.
Erreur de vérification	La vérification sort des limites de l'erreur	<ul style="list-style-type: none"> • Mélanger la norme de vérification avant la vérification. • Vérifier les critères de réussite/échec pour s'assurer que les critères ne sont pas plus stricts que la précision de la norme et ajuster ces critères en conséquence. • Vérifier la date d'expiration de la norme

7 Accessoires et pièces de rechange

7.1 Liste des accessoires

Titre		Code
ASM, 3 Batterie de piles, HR6, AA, Ni-MH	TB 350 IR turbidimètre portable, TB 350 WL turbidimètre portable	19820-011
Bloc d'alimentation serie TB	TB 350 IR turbidimètre portable, TB 350 WL turbidimètre portable	19820-170
Brosse, longueur 11 cm	TB 350 IR turbidimètre portable, TB 350 WL turbidimètre portable	380230
Câble USB-C 1 m, USB-C vers A	TB 350 IR turbidimètre portable, TB 350 WL turbidimètre portable	19820-081
Chiffon de nettoyage	TB 350 IR turbidimètre portable, TB 350 WL turbidimètre portable	197635
Cuves de mesure à couvercle noir, hauteur 55 mm, ø 24 mm, lot de 12	TB 350 IR turbidimètre portable, TB 350 WL turbidimètre portable	197655
Huile de silicone	TB 350 IR turbidimètre portable, TB 350 WL turbidimètre portable	194295
Lot d'étalons de turbidité T-CAL (5, 20, 800, 2000, 4000 NTU)	TB 350 WL turbidimètre portable	194152
Lot d'étalons de turbidité T-CAL (5, 20, 800, 4000 NTU)	TB 350 IR turbidimètre portable	194154

Titre		Code
Piles (AA), lot de 4	TB 350 IR turbidimètre portable, TB 350 WL turbidimètre portable	1950025
Porte-cuves pour 6 cuves rondes Ø 24 mm	TB 350 IR turbidimètre portable, TB 350 WL turbidimètre portable	418951
T-CAL®-Standard, 4000 NTU, 125 ml	TB 350 IR turbidimètre portable, TB 350 WL turbidimètre portable	48012912
T-CAL®-Standard, 4000 NTU, 500 ml	TB 350 IR turbidimètre portable, TB 350 WL turbidimètre portable	48012950

7.2 Pièces de rechange

Description	Numéro d'article
Mallette de transport	19820-130
Couvercle, chambre à échantillon	19820-095
Couvercle, compartiment de la batterie	19820-098
Bouchon, élastomère, IP67, I/O	19820-084
Insert pour 4 piles AA	19820-012

8 Spécifications

Model	Model WM-040-1004 (IR) Model WM-040-1001 (WL)
Source lumineuse	LED infrarouge (860 nm) LED blanche
Conformité réglementaire	ISO 7027 Approuvé par l'EPA (alternative à l'US EPA 180.1)
Principe	Néphélométrie (Multipath 90° BLAC)
Gamme de mesure	0,01 - 4000 NTU (FNU)
Résolution	Autoranging: 0.01-9.99: 0.01 NTU ; 10.0-99.9: 0.1 NTU ; 100-4000: 1 NTU
Précision	± 1,8 % de la lecture + lumière parasite
Répétabilité	< 1 % ou ± 0.01 NTU
Lumière diffusée	< 0.014 NTU
Unité affichée	NTU, FNU, degrés, mg/L Kaolin, mg/L PSL
Temps de réaction	7 secondes
Modes de lecture	Célibataire, Signal moy., Fast-Settling
Options d'étalonnage	Étalonnage de la gamme complète de 0 à 4000 NTU
Détecteur	Photodiode en silicium
Mode Ratio	oui
Volume d'échantillon requis	10 mL (0,4 oz)
Display	Écran tactile en couleur
Taille d'affichage	55 x 95 mm (L x H)
Interfaces	<ul style="list-style-type: none"> • USB-A • USB-C
Data Logger	250 mesures, tous les étalonnages, les vérifications et les rétablissements d'usine
Format de transfert des données	.csv
Mode économie d'énergie	oui
Auto – OFF	Sélectionnable

Alimentation	<ul style="list-style-type: none"> • 3 NiMH-battery pack (AA) • 4 batteries (AA) • Universal (90 - 240 VAC), via external power supply
Conditions environnementales	Température : 0 - 50 °C (32 - 122 °F) Humidité : 0 - 90 % à 30 °C, sans condensation Humidité : 0 - 80 % à 40 °C, sans condensation Humidité : 0 - 70 % à 60 °C, sans condensation
Classe de protection	IP 67 (instrument) -
Conformité	<ul style="list-style-type: none"> • CE • CSA • FCC A • RoHS • TÜV • UL • WEE
Langues interface d'utilisateur	<ul style="list-style-type: none"> • Allemand • Anglais • Chinois • Espagnol • Français • Japonais • Néerlandais • Polonais • Portugais • Turc
Langues Guide de démarrage rapide	<ul style="list-style-type: none"> • Allemand • Anglais • Chinois • Espagnol • Français • Italien • Néerlandais • Portugais • Russe • Turc

Langues Manuel d'utilisateur complet	<ul style="list-style-type: none"> • Allemand • Anglais • Chinois • Espagnol • Français • Italien • Néerlandais • Portugais • Russe • Turc
Dimensions	155 x 83 x 225 mm
Poids	804 g (898 g with four AA alkaline batteries)
Poids avec emballage	(898 g with four AA alkaline batteries)

**Attention!**

Sous réserve de modifications techniques !
 Pour garantir une précision maximale des résultats des tests, utilisez toujours les systèmes de réactifs fournis par le fabricant de l'instrument.

8.1 Spécifications - Adaptateur secteur

Type	WR9QA2500USB52NMR6B
Design	Fiche de l'adaptateur secteur, alimentation à découpage
Tension d'entrée, fréquence	100 – 240 V \pm 10 %, 50 / 60 Hz \pm 5 %
Courant d'entrée	0,3 A
Adaptateur primaire	Europe, Royaume-Uni, Australie, États-Unis
Classe de protection	II
Tension de sortie, fréquence	5,2 V, DC
Courant de sortie max.	2,5 A
Protection de la sortie	Arrêt de la sortie et redémarrage automatique
Conditions environnementales	0 °C à 40 °C, avec max. 95 % d'humidité relative de l'air
Classe d'efficacité énergétique	VI
Norme de sécurité	EN 62368
EMC	EN 55032 FCC Part 15 Class A EN 55024

Type	WR9QA2500USB52NMR6B
Dimensions [mm]	31,5 x 41 x 71 (sans adaptateur primaire)
Poids, avec adaptateur EU	48 g (sans lames d'adaptateur primaire)
Approbation, EMC	CE, FCC
Altitude autorisée mètres	5000 m
Niveau de pollution	2

**Attention!**

Sous réserve de modifications techniques !
Pour garantir une précision maximale des résultats des tests,
utilisez toujours les systèmes de réactifs fournis par le fabricant de
l'instrument.

9 Appendice

9.1 Avis sur les droits d'auteur et les marques de commerce

Lovibond®, Tintometer® et T-CAL® sont des marques déposées du groupe de sociétés Tintometer. Toutes les traductions et translittérations de Lovibond® et Tintometer® sont revendiquées comme des marques commerciales du Tintometer® Group.

La marque Bluetooth®, la marque figurative et la marque combinée sont des marques commerciales appartenant à Bluetooth SIG et toute utilisation par le Tintometer® Group est sous licence.

Índice

	Página
1 Introdução	166
1.1 Informações gerais	166
1.1.1 Leia as instruções antes de usar	166
1.1.2 Finalidade do Produto	166
1.1.3 Uso autorizado	166
1.1.4 Requisitos para uma utilização segura	166
1.1.5 Manual de instruções	167
1.1.6 Qualificação do usuário	167
1.1.7 Manuseio de produtos químicos perigosos	167
1.1.8 Observações para o descarte	167
1.2 Lista de todos os símbolos utilizados no documento	168
1.3 Abreviaturas	168
2 Resumo do produto	169
2.1 Certificação	169
2.2 Características	170
2.3 Descrição do produto	170
2.4 Vista do instrumento	171
3 Comissionamento	172
3.1 Ambiente operacional	172
3.2 Conteúdo da entrega	172
3.3 Instalação ou Substituição das Pilhas/ Baterias	173
4 Operação	175
4.1 Comissionamento inicial	175
4.2 Princípios gerais de funcionamento	176
4.3 Lista de ícones e suas funções	177
4.3.1 Lista de ícones e sua função	177
4.3.2 Lista de elementos de controlo e sua função	178
4.3.3 Barra de estado	180
4.4 Medição	181
4.4.1 Resumo das medições	181
4.4.2 Realização de uma medição	182
4.4.3 Dicas de medição	183
4.4.4 Configurações para a medição	184
4.5 Calibração	185
4.5.1 Visão Geral da Calibração	185
4.5.2 Realizar uma Calibração	185
4.5.3 Configurações de Calibração	186

	Página
4.6 Verificação	187
4.6.1 Visão geral da verificação	187
4.6.2 Realização de uma Verificação	188
4.6.3 Configurações de verificação	189
4.7 Registos	189
4.7.1 Selecção de um tipo de registo	189
4.7.2 Recuperar um registo	190
4.8 Configuração de instrumentos	190
5 Manutenção	194
5.1 Rotina de manutenção recomendada	194
6 Resolução de problemas	196
6.1 Mensagens de erro e o que fazer	196
7 Acessórios e peças de substituição	198
7.1 Lista de Acessórios	198
7.2 Lista de acessórios	198
8 Especificações	199
8.1 Especificações - Adaptador de rede elétrica	201
9 Apêndice	203
9.1 Aviso de Direitos do Autor e Marca Registrada	203

1 Introdução

1.1 Informações gerais

1.1.1 Leia as instruções antes de usar

Este manual fornece informações importantes sobre o uso seguro do produto. Leia atentamente este manual e familiarize-se com o produto antes de utilizá-lo.

1.1.2 Finalidade do Produto

O turbidímetro portátil da série TB foi projetado para analisar amostras aquosas que são recolhidas em cubetas de vidro e depois fechadas. A cubeta é preparada para a medição usando uma técnica cuidadosa para minimizar a interferência ocasionada por poeiras e arranhões. Após a preparação, a cubeta é colocada no instrumento para a medição.

O instrumento pode ser utilizado no laboratório ou levado para o campo para fazer medições em amostras à medida que são recolhidas.

Deve-se ter cuidado ao transportar o turbidímetro. Se o instrumento for levado para o campo, deve-se utilizar a maleta de transporte. Se o instrumento tiver de ser utilizado para aplicações regulamentadas, é aconselhável contatar as autoridades locais para assegurar-se de que o modelo de instrumento selecionado está correto.

1.1.3 Uso autorizado

A responsabilidade e garantia do fabricante por danos é anulada com o uso inadequado, não cumprimento deste manual, utilização por pessoal não qualificado, ou alterações não autorizadas no produto.

O fabricante não é responsável por custos ou danos que possam surgir por parte do usuário ou de terceiros devido à utilização deste produto, especialmente em casos de uso indevido, mau uso ou falhas relacionadas ao produto.

O fabricante não assume qualquer responsabilidade por erros de impressão.

1.1.4 Requisitos para uma utilização segura

Observar os seguintes pontos para uma utilização segura do equipamento:

- Se o equipamento for utilizado de uma forma não especificada pelo fabricante, a protecção fornecida pelo equipamento pode ser prejudicada.
- O produto só pode ser utilizado de acordo com a utilização autorizada especificada acima.
- O produto só pode ser fornecido com energia eléctrica fornecida pelas fontes de energia mencionadas neste manual de instruções.
- O produto só pode ser utilizado sob as condições ambientais mencionadas neste manual de instruções.
- O produto não deve ser aberto ou modificado.

O produto não deve ser utilizado se:

- estiver visivelmente danificado (por exemplo, após ter sido transportado)
- tiver sido armazenado em condições adversas durante um longo período de tempo (sobre as condições de armazenamento, ver capítulo "Especificações")

Pré-requisitos para o uso seguro da fonte de alimentação encaixável (plug-in).

Observar os seguintes pontos para uma utilização segura:

- Verificar se existem danos visíveis antes de usar. Se o equipamento estiver danificado, não colocá-lo em funcionamento.
- Utilizá-lo apenas em salas secas.
- Manuseá-lo apenas com as mãos secas.
- Só deverá ser utilizada a fonte de alimentação recomendada pelo fabricante.
- O produto não deverá ser aberto ou modificado.
- Apenas o cabo USB-C recomendado pelo fabricante deverá ser utilizado para a alimentação do dispositivo.

1.1.5 Manual de instruções

O manual deve ser mantido próximo do produto para que seja sempre possível encontrar a informação necessária.

1.1.6 Qualificação do usuário

O usuário deve ser capaz de compreender e implementar corretamente os rótulos de segurança e as instruções de segurança nas embalagens e folhetos dos produtos.

O usuário deve ser capaz e hábil para ler e compreender este manual, a fim de familiarizar-se com o seu manuseio e de garantir uma utilização segura.

1.1.7 Manuseio de produtos químicos perigosos

Podem existir riscos químicos e/ou biológicos quando este produto for utilizado. Respeitar todas as leis, regulamentos e protocolos que regem a utilização deste produto.

Para o desenvolvimento de seus produtos, a Lovibond® presta muita atenção à segurança. Porém, alguns perigos decorrentes de substâncias perigosas podem não ser evitáveis. Se forem utilizados testes ou soluções produzidas pelo usuário, a responsabilidade por quaisquer riscos causados por esses testes ou soluções recai sobre o utilizador (responsabilidade pessoal).

Para a sua própria proteção, para padrões de turbidez superiores a 5 NTU, recomenda-se o uso de luvas ou óculos de proteção. Observar a ficha de dados de segurança aplicável.

As fichas de dados de segurança dos produtos químicos incluem todas as instruções sobre o manuseio seguro, riscos, ações preventivas e ações a tomar em situações perigosas.

1.1.8 Observações para o descarte

Eliminar baterias e equipamentos elétricos de forma adequada, de acordo com a legislação local.

É ilegal eliminar as pilhas juntamente com resíduos domésticos.

Dentro da União Europeia, no final da vida do dispositivo, as baterias são eliminadas num ponto especializado de coleta para reciclagem.



Os instrumentos marcados com este símbolo não devem ser eliminados nos resíduos domésticos normais.

1.2 Lista de todos os símbolos utilizados no documento

Os seguintes símbolos são utilizados neste manual para indicar as seções que requerem atenção especial:



Perigo!

Indica um perigo que poderá resultar em morte ou ferimentos graves se não for evitado!



Advertência.

O manuseio inadequado de certos reagentes pode prejudicar a sua saúde. Em qualquer caso, seguir as informações das etiquetas de segurança da embalagem, as instruções de segurança no manual da embalagem e a ficha de dados de segurança disponível. Deve-se seguir exatamente as medidas de proteção ali especificadas.



Cuidado!

Existe um perigo que poderá resultar em lesões menores ou moderadas.

1.3 Abreviaturas

Abreviaturas	Definição
NTU	Nephelometric Turbidity Unit
FNU	Formazin Nephelometric Units
mg/l	Miligrama por litro

2 Resumo do produto

2.1 Certificação

EMC Emissões conduzidas e irradiadas	CISPR 11 (Limites da Classe A)	Marca CE
EMC Imunidade	EN 61326-1 (Limites industriais)	Marca CE
Segurança	EN 61010-1	Marca de segurança TÜV
FCC	FCC Classe A	Marca FCC

PT

Aviso FCC Classe A

Este dispositivo está em conformidade com a Parte 15 das Regras da FCC. O seu funcionamento está sujeito às duas condições seguintes:

- Este dispositivo não pode causar interferências nocivas.
- Este dispositivo deve aceitar qualquer interferência recebida, incluindo interferências que possam causar um funcionamento indesejável.

Nota: Este equipamento foi testado e considerado em conformidade com os limites para um dispositivo digital de Classe A, nos termos da Parte 15 das Normas da FCC. Estes limites são concebidos para proporcionar uma protecção razoável contra interferências prejudiciais quando o equipamento é operado num ambiente comercial. Este equipamento gera, utiliza e pode irradiar energia de radiofrequência e, se não for instalado e utilizado de acordo com o manual de instruções, pode causar interferências nocivas às comunicações por rádio. A operação deste equipamento numa área residencial é susceptível de causar interferências prejudiciais, caso em que o utilizador será obrigado a corrigir a interferência à sua custa.

Cabos blindados



As ligações entre o sistema e os seus periféricos devem ser feitas utilizando cabos blindados, a fim de manter a conformidade com os limites de emissão de radiofrequências da FCC.

Cuidado!

Modificações



Quaisquer modificações feitas a este dispositivo que não sejam aprovadas pelo Tintometer podem anular a autorização concedida ao utilizador pela FCC para operar este equipamento.

Cuidado!

PT

Aviso DOC Classe A - Avis DOC, Classe A

Este aparelho digital de Classe A cumpre todos os requisitos do Canadian Interference-Causing Equipment Regulations.

2.2 Características

A precisão do laboratório encontra a portabilidade

A série Lovibond® TB elimina as complexidades na medição da turbidez. Esta nova tecnologia proporciona o mais alto nível de precisão, eficiência operacional e regulamentar.

- Interface com tela de toque para maior facilidade de operação
- Instruções orientadas por imagens para guiar o utilizador ao longo das etapas do processo e evitar erros.
- Protocolos simples de gestão de dados para assegurar a integridade dos dados

2.3 Descrição do produto

A turbidez é uma expressão das propriedades ópticas de uma amostra que provoca a dispersão e absorção dos raios de luz em vez de serem transmitidos em linhas rectas através de uma amostra fluida. Na água, a turbidez é frequentemente causada pela presença de matéria como a argila, lodo, matéria orgânica finamente dividida, plâncton, outros organismos microscópicos, ácidos orgânicos, e pigmentos. A medição da turbidez é utilizada para monitorizar processos que removem ou alteram as concentrações de partículas em soluções, tais como na produção de água potável. Estes turbidímetros Lovibond® são concebidos para combinar a alta precisão e alta sensibilidade que se espera de um turbidímetro de laboratório com portabilidade.

2.4 Vista do instrumento

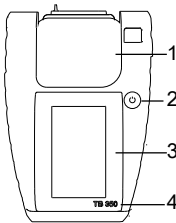
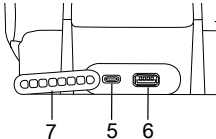
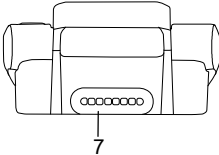
Posição	Descrição	Função
	<p>1. Tampa</p> <p>2. Botão de alimentação</p> <p>3. Tela de toque</p> <p>4. Número do modelo</p>	<p>Quando levantada, permite ao utilizador colocar a cubeta de amostra no instrumento para efetuar a leitura.</p> <p>Liga e desliga o instrumento.</p> <p>Apresenta a interface do utilizador do instrumento.</p> <p>Identifica a versão do instrumento.</p>
	<p>5. Porta USB-C</p> <p>6. Porta USB-A</p>	<p>Fornece energia ao instrumento a partir de uma fonte externa ou recarregará o acessório da bateria (se instalado).</p> <p>Suporta dispositivo externo USB-A para funções tais como transferência de dados ou backups.</p>
	<p>7. Vedação</p>	<p>Usada para cobrir as portas USB quando as conexões não estão sendo utilizadas.</p>

3 Comissionamento

3.1 Ambiente operacional

O instrumento pode ser utilizado em qualquer ambiente interior ou exterior que seja considerado seguro para um usuário realizar a análise.

O instrumento pode aceitar amostras aquosas, de 0 a 70 °C.

O instrumento deve estar nivelado, a $\pm 15^\circ$, ao realizar uma medição.

O instrumento deve ser colocado sobre uma superfície plana para que se obtenha o melhor desempenho na medição.

PT

3.2 Conteúdo da entrega

Inspecionar cuidadosamente todos os itens para assegurar-se de que cada um dos itens marcados na lista abaixo esteja presente e que não ocorreram danos visíveis durante o envio. Se houver algum dano ou se faltar alguma coisa, por favor entre imediatamente em contato com o seu distribuidor local.

TB	350 IR	350 WL
Instrumento	X	X
Óleo de Silicone, 15 ml	X	X
Pano de Microfibra	X	X
2 x Cubetas de amostra	X	X
Chave de fenda	X	X
Escova	X	X
Maleta de transporte	X	X
Guia de Início Rápido	X	X
Certificado de Conformidade	X	X
Informações de Garantia	X	X
4 x Pilhas AA	X	X
Pacote de pilhas recarregáveis		
Cabo USB-C		
Fonte de alimentação CA		
Adaptadores para tomadas dos EUA, Reino Unido e UE		
T-CAL® Standard, 5 NTU	X	X
T-CAL® Standard, 20 NTU	X	X
T-CAL® Standard, 800 NTU	X	X
T-CAL® Standard, 2000 NTU		X
T-CAL® Standard, 4000 NTU	X	X

3.3 Instalação ou Substituição das Pilhas/ Baterias

Ao utilizar pilhas

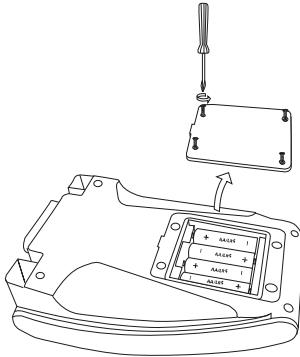

Passo	Descrição
1	Utilizar uma chave de fenda para remover os quatro parafusos na parte de traseira do instrumento e remover o painel.
2	Inserir as quatro pilhas AA na orientação adequada.
3	Fixar o painel de volta ao instrumento.



Atenção!

- Utilizar apenas o tipo aprovado: pilha alcalina de manganês, LR6, com voltagem de 1,5V.
- Retirar as pilhas esgotadas da unidade o mais rapidamente possível.
- Se o equipamento não for utilizado durante muito tempo, remover as pilhas da unidade.

Ao utilizar un conjunto de baterias recarregáveis

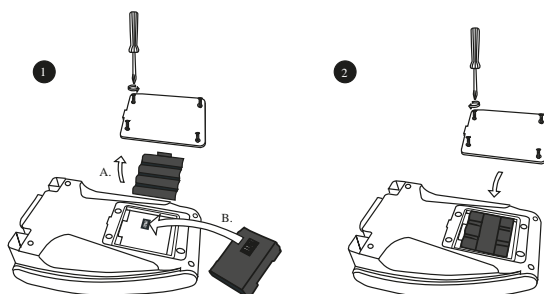

Passo	Descrição
1	Utilizar uma chave de fenda para retirar os quatro parafusos na parte traseira do instrumento, retirar o painel e o suporte de pilhas.
2	Inserir o conjunto de baterias recarregáveis na orientação correcta.
3	Fixar o painel de volta ao instrumento.



Advertência

O conjunto de baterias recarregáveis (19820-011) só é compatível com instrumentos com o número de série 23041000 e superior.

A utilização do conjunto de baterias em instrumentos com números de série anteriores a 23041000 pode provocar o sobreaquecimento do dispositivo durante o carregamento. Este sobreaquecimento pode levar a leituras incorrectas e a danos no dispositivo, pelo que deve ser evitado. Para instrumentos com número de série inferior a 23041000, contactar a Lovibond® para obter informações sobre a utilização deste acessório.

4 Operação

4.1 Comissionamento inicial



1. Tela de boas-vindas

A primeira tela que o usuário vê ao ligar.

Aperte > botão



2. Selecione o Idioma

Selecione o idioma desejado.

Aperte > botão



3. Definir data e hora

Escolha entre o formato de 12 e 24 horas.

Alterar valores usando setas para cima e para baixo.

Aperte > botão



4. Senha

Definir uma senha definida pelo usuário para implementar características de segurança no instrumento.

Aperte o botão Guardar.

Se não for desejada nenhuma senha, selecione "Pular".

Aperte > botão



5. Unidades padrão

Selecione o tipo de unidade desejada.

Aperte > botão



6. Detalhes de contato

Introduza a informação do proprietário do instrumento.

Aperte o botão Guardar.

Se nenhum detalhe for desejado, selecione "Pular".

Aperte > botão



7. Tela de resumo

Revisão da configuração inicial.

Aperte < para alterar a configuração antes de prosseguir.

Pressione > para prosseguir com a tela inicial.

O utilizador pode selecionar a tarefa a executar com o instrumento.

4.2 Princípios gerais de funcionamento

Os desenhos dos Turbidímetros Portáteis da Série TB são decompostos nos seus respectivos componentes funcionais que são discutidos em detalhe. Estes incluem a fonte de luz, a armadilha de luz dispersa a 90 graus, o detector de luz dispersa, o frasco de amostra do turbidímetro e a forma como estes componentes-chave trabalham em conjunto para fornecer o resultado da turbidez.

PT

A configuração óptica simplificada para a série TB de Turbidímetros Portáteis. Esta figura mostra o percurso da luz incidente e a vista do detector de luz dispersa a 90°.

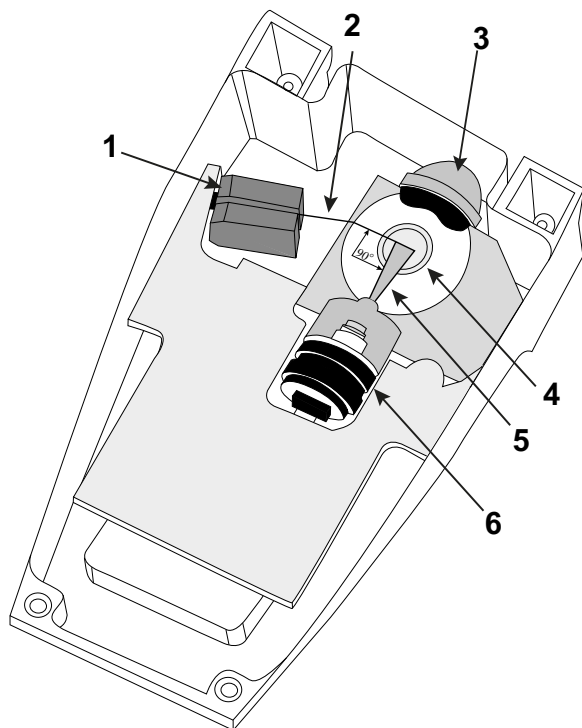





- 1 Iluminador (LED e Óptica)
- 2 Caminho da Luz Incidente
- 3 90° Armadilha de luz
- 4 Tubo de Amostra
- 5 Luz dispersa (10°-20° Detector View)
- 6 Detector de luz dispersa e Óptica



4.3 Lista de ícones e suas funções

4.3.1 Lista de ícones e sua função











Descrição	Função
1 Barra de estado	Apresenta os ícones e etiquetas que são universais, incluindo Tempo, Bluetooth®, USB, Segurança, Fonte de Luz e Energia.
2 Área de Ação	Área que exhibe as etapas de aplicação e interação
3 Barra Home	Utilizada principalmente para navegação, para iniciar, guardar ou arquivar ações e regressar à Home.

Ícone	Descrição
	Modo de medição
	Modo de Calibração
	Modo de Verificação
	Registos de dados

Ícone	Descrição
	Conexão Bluetooth ao turbidímetro de processo PTV (não disponível para TB 350)
	Configurações do instrumento

PT

4.3.2 Lista de elementos de controlo e sua função

Ícone	Descrição	Função
	Nome da Aplicação	Título do aplicativo que o utilizador está actualmente a utilizar.
	Hora	Tempo definido pelo utilizador na configuração inicial ou através do acesso às configurações do instrumento. O formato de 12 horas ou 24 horas está disponível.
	USB	Se exibido, indica que um módulo USB está ligado à unidade.
	Ícone Bluetooth - Liso ²⁾	Se exibido, o módulo Bluetooth® é anexado.
	Ícone Bluetooth - Com setas ²⁾	Se exibido, o módulo Bluetooth® é anexado e comunica activamente com uma aplicação PTV ou AquaLX.
	Fonte de luz vermelha - preenchidas	O instrumento contém uma fonte de luz LED vermelha; a luz é ligada para medição.
	Fonte de luz vermelha - esboço	O instrumento contém uma fonte de luz LED vermelha; nenhuma medição está activa.
	Fonte de luz branca - preenchidas	O instrumento contém uma fonte de luz LED branca; a luz é ligada para medição.
	Fonte de luz branca - esboço	O instrumento contém uma fonte de luz LED branca; nenhuma medição está activa.



Ícone	Descrição	Função
	Fonte de luz infravermelha - On	O instrumento contém uma fonte de luz LED infravermelha; a luz é ligada para medição.
	Fonte de luz infravermelha - Off	O instrumento contém uma fonte de luz LED infravermelha; nenhuma medição está activa.
	Fonte de luz laser – preenchidas ¹⁾	O instrumento contém uma fonte de luz laser LED; a luz é ligada para medição.
	Fonte de luz laser – esboço ¹⁾	O instrumento contém uma fonte de luz laser LED; nenhuma medição está activa.
	Carregamento de baterias AC	Bateria AC está a carregar.
	Ícone de potência AC	Indica que o instrumento é alimentado através de corrente alternada.
	Energia da bateria - Verde	Indica uma duração de 100% dos restos de bateria.
	Energia da bateria – Amarelo	Indica 75% da duração da bateria restante.
	Energia da bateria – Laranja	Indica 50% da duração da bateria restante.
	Energia da bateria - Vermelho	Indica 25% da duração da bateria restante.
	Tampa da câmara de medição aberta	Indica que a tampa da câmara de medição está aberta.
	Tampa da câmara de medição fechada	Indica que a tampa da câmara de medição está fechada.

¹⁾ apenas TB 600

2) não TB 350

4.3.3 Barra de estado

Ícone	Descrição	Função
	Botão Home	Devolve o utilizador ao ecrã inicial.
	Botão Home - Bloqueado	A segurança está activa; a palavra-passe foi activada e é necessária para desempenhar determinadas funções.
	Botão Home - Desbloqueado	A segurança está inactiva; nenhuma função está bloqueada para o utilizador.
	Botão Guardar	Guarda o conteúdo exibido na área activa.
	Botão Definições	Abre o menu de configuração de uma aplicação.
	Botão de exportação	Exporta o(s) registo(s) exibido(s) na área activa.
	Botão de medição	Inicia ou Começa ou Inicia uma medição.
	Botão de medição - com Bluetooth ⁽²⁾	Efectua uma medição enquanto ligado a uma unidade PTV.
	Botão de Actualização Bluetooth ⁽²⁾	Actualiza a lista de unidades PTV disponíveis na proximidade do instrumento.

Ícone	Descrição	Função
	Botão Cancelar	Dá a opção de cancelar a actividade actual na área activa.
	Chevron direito	Avançar para o próximo passo dentro de um processo.
	Chevron esquerdo	Retorno a uma etapa anterior dentro de um processo.

²⁾ não TB350

4.4 Medição

4.4.1 Resumo das medições

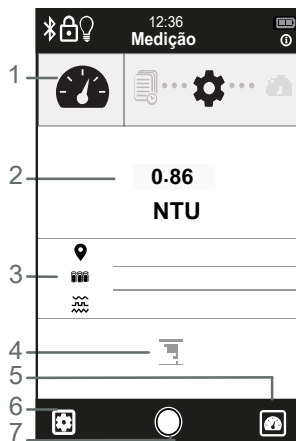

Descrição	Função
1 Barra de aplicação	Caminho de navegação para ajudar o utilizador ao longo das etapas do processo.
2 Valor de Medição	Exibição do resultado da medição com unidade.
3 Configurações	São apresentadas as configurações aplicadas à medição.
4 Botão Log	Cria um Registo quando pressionado.
5 Botão de medição	Inicia uma medição quando pressionado.
6 Botão Configurações	Utilizado para alterar configurações.

Descrição**Função****7 Botão Home**

Devolve o usuário à tela inicial.

4.4.2 Realização de uma medição

Por favor, antes da medição preparar as cubetas de amostra fornecidas. Certifique-se de que as cubetas de amostra estejam limpas e livres de arranhões ou manchas.

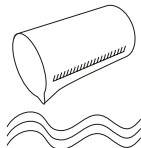
**1. Coleta da amostra**

Assegurar-se que a amostra seja representativa (bem misturada).

Os frascos devem estar limpos e livres de arranhões ou manchas.

Lavar o frasco de coleta pelo menos duas vezes com amostra antes da coleta da amostra.

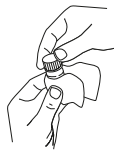
**2. Preparar a cubeta**

Utilizando um pano livre de fiapos, secar o exterior da cubeta de medição.

Utilizar óleo de silicone para minimizar os efeitos de luz difusa.

**3. Inserir a cubeta no instrumento**

Certificar-se de que a amostra esteja livre de bolhas.

Inverter lentamente para misturar. Não agitar.

**4. Fechar a tampa**

A medição não será permitida sem a tampa no lugar.

**5. Verificar as Configurações**

Assegurar-se de que as configurações de medição estejam corretas. As configurações de medição não poderão ser alteradas após a realização da medição.

**6. Botão de Medição**

Inicia a medição.

**7. Registos de dados**

Introduza o Registo de Dados para guardar a medição.

**8. Salvar a Medição**

Se desejar, aperte o botão Guardar para criar um registo de medição.



9. Pausa

Pausa a medição em modo de medição "contínuo".



- Não inserir quaisquer objetos na câmara de medição, excepto as cubetas destinadas às medições.
- Não inserir quaisquer líquidos na câmara de medição.

Advertência!

PT

4.4.3 Dicas de medição

Indexação do célula: A melhor forma de o fazer é com um célula que é enchido com água que é filtrada através de um filtro de 0,2 µm.

- Premir o botão Medição.
- Rodar a amostra. Ao rodar o célula, identificar a leitura mais baixa.
- Quando a posição for determinada, parar a medição. Marcar o célula.
- Antes de proceder a medições adicionais, assegurar-se de que o modo de medição é actualizado, conforme necessário.
- Recomenda-se a indexação do célula de amostra se houver um risco perceptível ou um buraco no vidro.

Utilização de Óleo de Silicone

- Cuidado para manusear o célula apenas pelo terço superior.
- Limpar o célula com o pano de limpeza fornecido para remover a água, o pó e as impressões digitais.
- Olear o exterior do célula com óleo de silicone.
 - Colocar uma gota muito fina de óleo de silicone na lateral do célula. Espalhar uniformemente o grânulo de óleo sobre os 2/3 do fundo do célula.
 - Limpar o silicone da célula através da rotação da célula contra um pano limpo e sem pó.
- As células oleosas são críticas e recomendadas ao medir amostras com uma turbidez esperada inferior a 0,5 NTU.

Amostras que contenham bolhas em excesso

- Deixar a amostra de pé durante um mínimo de cinco minutos.
- Inverter suavemente a amostra duas a três vezes para ressuspender a turbidez.
- Colocar no instrumento e proceder como instruído.

Outras Notas

- O uso de banhos ultra-sónicos não é recomendado. A energia ultra-sónica pode alterar a distribuição de partículas.
- Utilizar o Modo de Regulação Rápida para amostras que tenham altas concentrações de areias ou partículas de alta densidade.

4.4.4 Configurações para a medição



Prima o botão Definições para aceder ao Modo de Definições de Medição.

Ícone	Descrição	Opção	Função
	Modo	Única	Pressione para activar uma medição
		Contínuo ¹⁾	As medições são actualizadas a cada X segundos até serem interrompidas.
		Sedimentação Rápida	Recomendado para amostras com características de Sedimentação rápida.
	Localização	Padrão	Usado se não estiver definida uma identificação personalizada.
		Personalizado	Descrição personalizada do local de medição e limites de medição.
	Média de leituras	Ligado	Se estiver ligado, pode ser configurado até 255 medições. A função deve ser utilizada se as medições forem instáveis.
		Fora	Desactivado
	ID da amostra	Padrão	Usado se não estiver definida uma identificação personalizada.
		Personalizado	Identificador único de amostra; seleccionável pelo utilizador.

¹⁾ não TB350

4.5 Calibração

4.5.1 Visão Geral da Calibração

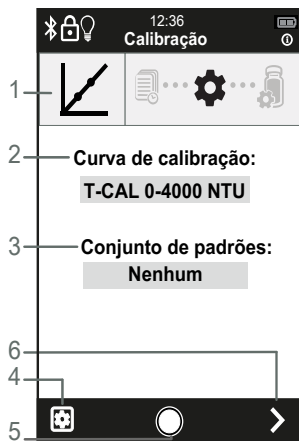

Descrição	Função
1 Barra de aplicação	Caminho de navegação para ajudar o utilizador ao longo das etapas do processo.
2 Curva de Calibração	Especifica o tipo de calibração.
3 Conjunto de padrões	Identificador único do conjunto de padrões.
4 Botão de Configurações	Utilizado para alterar configurações.
5 Botão Home	Devolve o usuário à tela inicial.
6 Próximo Botão	Avançar para a próxima tela.

4.5.2 Realizar uma Calibração

Por favor, preparar os padrões T-CAL® incluídos no âmbito da entrega antes da calibração. Certifique-se de que os frascos de padrão T-CAL® estejam limpos e livres de arranhões ou manchas.

- Padrões T-CAL® para TB 350 IR: 20 / 800 / 4000 NTU
- Normas T-CAL® para TB 350 WL: 20 / 800 / 2000 / 4000 NTU

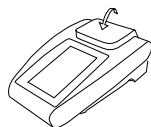

- 1. Ajuste de Zero:**
Realiza um ajuste de zero.

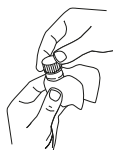
**2. Preparar a cubeta:**

Utilizar óleo de silicone na cubeta, se necessário.

**3. Inserir o padrão:**

Inserir o valor do padrão especificado na tela.

O usuário deverá inserir uma série de padrões de turbidez para completar a calibração.

**4. Modo:**

Representa um processo activo.

**5. Resumo do registo:**

Aperte o botão Guardar para guardar o registo.



Aperte o botão Cancelar para voltar ao início do processo de calibração.

4.5.3 Configurações de Calibração



Premir o Botão de Definições para aceder ao modo de definições.

Ícone	Descrição	Opção	Função
	Curva de calibração	T-CAL [®]	Selecciona padrão de formazina estabilizada preparada em concentrações pré-definidas
		Formazin (usuário)	Selecciona o padrão de formazina preparado pelo utilizador em concentrações pré-definidas
	Conjunto de padrões	Padrão	Utilizado se não estiver definido um identificador único.
		específico	Identificador único do conjunto padrão.
	Lembrete¹⁾	Ligado	Lembra o utilizador que a calibração é devida. Opção de forçar a Calibração antes de ocorrerem medições adicionais.
		Fora	Definição por defeito.
	Calib. padrão		Opção para voltar à configuração de calibração de fábrica.

	Verificação posterior	Ligado	Requer que o utilizador efectue uma Verificação após a calibração estar concluída.
		Fora	Definição por defeito.
	Verif. de Calib.	Ligado (Padrão)	Durante o procedimento de calibração, se um padrão individual estiver fora de tolerância, o utilizador deve corrigir o padrão para prosseguir ou cancelar o procedimento de calibração. A característica impede o utilizador de um erro de calibração devido a um padrão incorrecto. O ecrã de registo terá um item de linha para o Verificador de Calibração e mostrará um estado "On" ou "Enabled".
		Fora	Durante o procedimento de calibração, se um padrão individual estiver fora de tolerância, o utilizador não será notificado de que um calibrador está fora da gama pré-definida de Tintómetros. O ecrã de registo terá um item de linha para o verificador de calibração e mostrará um estado "Desligado" ou "Desactivado".

¹⁾ não TB350

4.6 Verificação

4.6.1 Visão geral da verificação

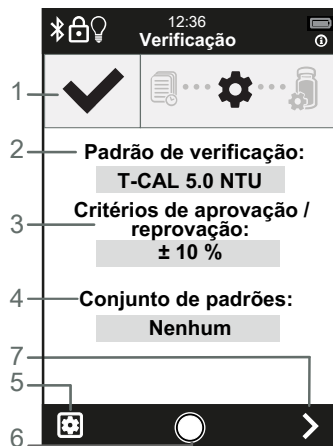

Descrição	Função
1 Barra de aplicação	Caminho de navegação para ajudar o utilizador ao longo das etapas do processo.
2 Norma de verificação	Valor do Padrão a ser medido.
3 Critérios de aprovação / reprovação	Tolerância utilizada para determinar se uma verificação passa ou falha.
4 Conjunto de padrões	Identificador único do conjunto padrão.
5 Botão Definições	Utilizado para alterar configurações.
6 Botão Home	Devolve o utilizador ao ecrã inicial.
7 Próximo Botão	Avançar para o próximo ecrã.

PT

4.6.2 Realização de uma Verificação

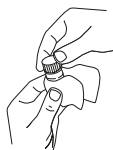

1. Preparar o célula:

Célula de amostra de óleo, se necessário.



3. Inserir Standard:

Inserir o valor standard especificado no ecrã.



4. Modal:

Representa um processo activo.



5. Resumo do registo:

Prima o botão Guardar para guardar o registo.

Premir o botão Cancelar para voltar ao início do processo de Verificação.

4.6.3 Configurações de verificação



Premir o botão Settings para entrar no modo settings.

Ícone	Descrição	Opção	Função
	Padrão	T-CAL 5.0 NTU	Selecciona padrão de formazina estabilizada preparada a 5,0 NTU de concentração.
		Usuário preparado	Selecciona o padrão preparado pelo utilizador entre 1 e 1000 NTU.
	Crítérios de Pass/Fail	±10%	Tolerância utilizada para determinar se uma verificação passa ou falha.
		± 5%	
		±0.05 NTU	
		±0.10 NTU	
	Lembrete¹⁾	Ligado	Lembra o utilizador que a verificação é devida.
		Desligado	Definição por defeito.

¹⁾ não TB350

4.7 Registos

4.7.1 Seleção de um tipo de registo



Prima o botão de tipo de registo na área de acção para aceder aos registos.

Barra de aplicação:



Registos de medição:

Mostra todas as medições registadas.



Registos de Calibração:

Exibe todos os registos de calibração.

**Registos de verificação:**

Exibe todos os registos de verificação.

1)

Registos do Modo BPL:

Apresenta registo do modo BPL a ser activado ou desactivado.

1) não TB 350

PT

4.7.2 Recuperar um registo

**1. Seleccionar o tipo de protocolo**

Mostra os registos do tipo de registo que o utilizador gostaria de ver.

**2. Exportar Registos Individuais**

Se for seleccionado um único registo, esse registo é exportado em formato CSV.

Todos os detalhes associados aos registos são exportados.

**3. Seleccionar o método de transferência**

USB: Exporta o protocolo para uma memória USB.



Bluetooth® 1): Registo de exportações para aplicação móvel AquaLX.

Não disponível em TB 350.

Nota: é necessário um dongle externo Lovibond® Bluetooth® para ligação à porta USB-A

1) não TB 350

4.8 Configuração de instrumentos



Premir o botão Settings Button para aceder ao Modo Settings.

Ícone	Descrição	Opção	Função
	Segurança	Habilitar	Configurar, verificar e alterar a palavra-passe.
		Desactivar	Definição por defeito.



Configurações de energia

Brilho da tela	Ajustar a luminosidade do ecrã.
Susp. da ilum. do display	desligado 20 segundos 30 segundos 1 minuto* 5 minutos
Desligamento do sistema	desligado 1 minuto 2 minutos 5 minutos 15 minutos* Nota: Ao utilizar o cabo de alimentação USB-C, o encerramento do sistema é definido como 'Desligado' até a unidade ser desligada e depois volta para a opção seleccionada.



Bluetooth¹⁾

Habilitar	Permite Bluetooth® quando o hardware está presente.
Desactivar	Definição por defeito.



Atalhos de USB¹⁾

Habilitar	Se activado, quando um dispositivo de armazenamento USB é ligado, o utilizador é apresentado com um modal que apresenta uma opção de "transferência de registos" ou definições de "cópia de segurança/ restauro". Ao seleccionar uma opção, o utilizador é direccionado para a função apropriada.
Desactivar	Configuração por defeito; os utilizadores devem aceder às configurações "Logs" ou "Backup/ Restauração" quando o dispositivo de armazenamento USB está ligado.



Idioma

Seleccionar idioma.



Data/Hora

Seleccionar o tempo apresentado e o formato.

Backup /
RestauraçãoFazer backup de todas as configurações¹⁾

Opção para armazenar configurações no cartão SD local ou guardar na unidade USB externa.

Restaurar todas as configurações¹⁾

Recupera configurações previamente guardadas em cartão SD local ou drive USB externo.

Restaurar configurações de fábrica

Reinicia todas as definições para os padrões de fábrica. Os registos guardados ainda estão disponíveis.

Tipo de
unidade

NTU

Seleccione a unidade apresentada.

FNU

mg/L Kaolin

mg/L PSL

Graus

mNTU¹⁾mFNU¹⁾Personalizado¹⁾

Define o tipo de unidade do valor de medição apresentado. NTU é a configuração por defeito.

Permitir o tipo de unidade definida pelo utilizador e a capacidade de definir um factor baseado em valores NTU/FNU.

GLP¹⁾

Habilitar

Estabelece protocolo de integridade de dados para laboratórios seguindo as Boas Práticas de Laboratório.

Desactivar

Definição por defeito.

**Proprietário**

Dados de contacto do proprietário do instrumento.

**Entre em contato**

Informação de contacto para os escritórios de Lovibond®.

**Sobre**

Sobre Lovibond®.

¹⁾ não TB 350

* Configuração por defeito

5 Manutenção

5.1 Rotina de manutenção recomendada

Tarefa	Fazer	Não fazer
1. Câmara de medição limpa 2. Tela do instrumento limpa	<ol style="list-style-type: none"> Assegurar-se de que a câmara de medição esteja limpa e seca antes da medição. Utilizar um pano seco de microfibras para remover as impurezas. Limpar a tela de toque com um pano de microfibras seco ou ligeiramente humedecido. 	<ol style="list-style-type: none"> Pulverizar ou verter qualquer fluido directamente para a câmara de medição. Medir uma amostra que não esteja bem tampada.
Limpeza do exterior do gabinete	Limpar o exterior do gabinete com uma solução detergente suave ou álcool diluído.	
Armazenamento e cuidados com as cubetas de amostra	Sempre lavar os frascos com água destilada ou deionizada após a utilização.	Usar óleo de silicone em excesso sem removê-lo da cubeta. Uma única gota é o suficiente.
	Encher o frasco com água DI. A Tampe o frasco para evitar a formação de manchas de água.	Deixe as cubetas de amostra destampadas para secar ao ar.
	Limpar o exterior da cubeta com um pano de microfibras.	Utilizar qualquer cubeta que possua imperfeições visíveis, incluindo marcas e riscos.
Substituição das pilhas	Sugere-se a remoção das pilhas se o instrumento for armazenado por mais de 30 dias para evitar o vazamento das pilhas.	Utilizar pilhas diferentes das especificadas.

Tarefa	Fazer	Não fazer
Calibração	<p>Calibrar conforme necessário de acordo com as seguintes condições:</p> <ol style="list-style-type: none"> 1. Falha na verificação. 2. Após realização de manutenção nos sistemas óptico ou eletrônico. 3. Conforme exigido pelas autoridades reguladoras regionais. 	Utilização de padrões vencidos.
	Siga cuidadosamente as instruções de preparação e utilização dos padrões.	
Verificação	<p>Verificar o desempenho do instrumento de acordo com as seguintes condições:</p> <ol style="list-style-type: none"> 1. Após realizar uma calibração. 2. Devido à procedimentos internos de controle de qualidade. 3. Conforme exigido pelas autoridades reguladoras regionais. 	Utilização de padrões vencidos.
	Siga cuidadosamente as instruções de preparação e utilização dos padrões.	
Conector/ Vedação	Certifique-se de que a tampa do conector esteja instalada quando não estiver em um ambiente de laboratório.	<p>Não armazenar a unidade sem a tampa de vedação instalada.</p> <p>Transportar ou suspender o instrumento por meio de um cabo de conexão.</p>

**Advertência.**

O manuseio inadequado de certos reagentes pode prejudicar a sua saúde. Em qualquer caso, seguir as informações das etiquetas de segurança da embalagem, as instruções de segurança no manual da embalagem e a ficha de dados de segurança disponível. Deve-se seguir exatamente as medidas de proteção ali especificadas.

6 Resolução de problemas

6.1 Mensagens de erro e o que fazer

Sintoma	Possível Causa	Solução
Acima da faixa	A turbidez da amostra é superior a faixa de medição do instrumento.	<ul style="list-style-type: none"> Diluir a amostra Verificar a calibração utilizando um padrão de faixa alta.
Abaixo do alcance	A turbidez da amostra é inferior ao limite de detecção do instrumento.	<ul style="list-style-type: none"> Repetir a medição da luz dispersa (ajuste zero) conforme descrito e certificar-se de que a tampa da amostra esteja fechada. Repetir a calibração após a luz difusa ter sido determinada.
O instrumento não liga	As pilhas estão defeituosas. As pilhas não estão inseridas corretamente.	<ul style="list-style-type: none"> Substituir as pilhas por um conjunto completo novo.
O botão "Guardar" para uma função não aparece, pelo que não pode ser criado um registo.	Faltam as informações necessárias.	Assegurar que as iniciais do utilizador e todos os outros campos obrigatórios são devidamente tratados.
O instrumento não realiza a medição	A tampa não está fechada.	Fechar a tampa.
Notificação de pilha fraca	A pilha está abaixo de 20%.	Substituir ou recarregar as pilhas.
As configurações do instrumento não podem ser acessadas pelo usuário.	O protocolo de segurança do instrumento está ativo.	Introduza a senha para desbloquear as definições e funções de Calibração.
Erro de Calibração	As cubetas de amostra não foram limpas antes da calibração.	<ul style="list-style-type: none"> Lavar novamente as cubetas de amostra utilizando o procedimento do manual. Armazenar os frascos conforme descrito no manual. Verificar a data de validade do padrão.

Sintoma	Possível Causa	Solução
Erro de Calibração	Os padrões de calibração foram utilizados na ordem errada.	Repetir a calibração com a ordem dos padrões do valor mais baixo para o mais alto.
Erro de Calibração	Os padrões de calibração não foram adequadamente misturados.	Misturar os padrões conforme as instruções imediatamente anteriores à realização da calibração.
Erro de Calibração	Padrões de calibração preparados para valores de turbidez incorretos.	Repetir a preparação dos padrões de calibração, certificando-se de que as diluições estejam corretas.
Erro de Verificação	A verificação está fora dos limites de erro.	<ul style="list-style-type: none"> • Misturar o padrão de verificação antes do uso. • Verificar os critérios de aprovação/reprovação para assegurar-se de que os critérios não sejam mais rigorosos do que a precisão do padrão e ajustar estes critérios em conformidade. • Verificar data de validade do padrão.

7 Acessórios e peças de substituição

7.1 Lista de Acessórios

Título	Artigo No
ASM, Pacote de baterias de 3 células, HR6, AA, Ni-MH	TB350 IR, TB350 WL 19820-011
Cabo USB-C de 1 m, USB-C para A	TB350 IR, TB350 WL 19820-081
Conjunto de padrões de turvação T-CAL (5, 20, 800, 2000, 4000 NTU)	TB350 WL 194152
Conjunto de padrões de turvação T-CAL (5, 20, 800, 4000 NTU)	TB350 IR 194154
Cubetas de medição com tampa preta, altura 55 mm, ø 24 mm, conjunto com 12	TB350 IR, TB350 WL 197655
Escova, 11 cm de comprimento	TB350 IR, TB350 WL 380230
Fonte de alimentação para a Serie TB	TB350 IR, TB350 WL 19820-170
Óleo de silicone	TB350 IR, TB350 WL 194295
Pano de limpeza	TB350 IR, TB350 WL 197635
Pilhas (AA), jogo com 4	TB350 IR, TB350 WL 1950025
Suporte de cubetas para 6 cubetas redondas de Ø 24 mm	TB350 IR, TB350 WL 418951
T-CAL®-Standard, 4000 NTU, 125 ml	TB350 IR, TB350 WL 48012912
T-CAL®-Standard, 4000 NTU, 500 ml	TB350 IR, TB350 WL 48012950

7.2 Lista de acessórios

Descrição	Número da peça
Maleta de transporte	19820-130
Tampa, compartimento de medição	19820-095
Tampa, compartimento de pilhas	19820-098
Tampão, elastômero, IP67, E/S	19820-084
Inserir para 4 pilhas AA	19820-012

8 Especificações

Model	Model WM-040-1004 (IR) Model WM-040-1001 (WL)
Fonte de Luz	LED infravermelho (860 nm) LED branco
Conformidade	ISO 7027 Aprovado pela EPA (alternativa à EPA 180.1 dos EUA)
Princípio de Medição	Nefelométrica (Multipath 90° BLAC)
Faixa de Medição	0,01 - 4000 NTU (FNU)
Resolução	0,01 NTU na faixa mais baixa
Precisão	± 1,8 % da leitura + luz dispersa
Repetibilidade	< 1 % ou ± 0,01 NTU
Luz Dispersa	< 0,014 NTU
Unidades de medição	NTU, FNU, graus, mg/L Caulim, mg/L PSL
Tempo de Resposta	7 seconds7 Sekunden7 secondes7 segundos7 secondi7秒7 saniye7 seconden7 секунд 7 Segundos
Modos de Leitura	Simple, Média de leituras, Fast-Settling
Opções de Calibração	Calibração de gama completa de 0 - 4000 NTU
Detector	Fotodíodo de silício
Modo Ratio	Sim
Volume necessário de amostra	10 mL (0,4 oz)
Display	Tela de toque colorida
Tamanho da tela	55 x 95 mm (L x A)
Interfaces	<ul style="list-style-type: none"> • USB-A • USB-C
Registrador de Dados	250 medições, todas as calibrações, verificações e restaurações de fábrica
Formato de transferência de dados	.csv

Modo de economia de energia	Sim
Auto – OFF	Seleccionável
Fonte de Alimentação	<ul style="list-style-type: none"> • 3 NiMH-battery pack (AA) • 4 batteries (AA) • Universal (90 - 240 VAC), via external power supply
Condições Ambientais	Temperatura: 0 - 50 °C (32 - 122 °F) Humidade: 0 - 90 % a 30 °C, sem condensação Humidade: 0 - 80 % a 40 °C (104 °F), sem condensação Humidade: 0 - 70 % a 60 °C, não-condensação
Grau de Proteção	IP 67 (Instrumento)
Conformidade	<ul style="list-style-type: none"> • CE • CSA • FCC A • RoHS • TÜV • UL • WEE
Idiomas da Interface do Usuário	<ul style="list-style-type: none"> • Alemão • Chinês • Espanhol • Francês • Holandês • Inglês • Japonês • Polonês • Português • Turco
Idiomas do Guia de Início Rápido	<ul style="list-style-type: none"> • Alemão • Chinês • Espanhol • Francês • Holandês • Inglês • Italiano • Português • Russo • Turco

Idiomas do Manual Completo do Usuário	<ul style="list-style-type: none"> • Alemão • Chinês • Espanhol • Francês • Holandês • Inglês • Italiano • Português • Russo • Turco
Dimensões	155 x 83 x 225 mm
Peso	804 g (898 g with four AA alkaline batteries)
Peso com embalagem	(898 g with four AA alkaline batteries)

**Cuidado!**

Sujeito a modificações técnicas!
Para assegurar a máxima precisão dos resultados das medições, utilizar sempre os acessórios e os reagentes fornecidos pelo fabricante do instrumento.

8.1 Especificações - Adaptador de rede elétrica

Tipo	WR9QA2500USB52NMR6B
Desenho	Ficha do adaptador de rede elétrica, fonte de alimentação haveada
Tensão de entrada, frequência	100 – 240 V \pm 10 %, 50 / 60 Hz \pm 5 %
Corrente de entrada	0,3 A
Adaptador primário	Europa, Reino Unido, Austrália, EUA
Classe de protecção	II
Tensão de saída, frequência	5,2 V, DC
Corrente máxima de saída	2,5 A
Protecção de saída	Encerramento da saída e reinício automático
Condições ambientais	0 °C a 40 °C, com um máximo de 95 % de humidade relativa do ar
Classe de eficiência energética	VI
Norma de segurança	EN 62368

Tipo	WR9QA2500USB52NMR6B
EMC	EN 55032 FCC Part 15 Classe A EN 55024
Dimensões [mm]	31,5 x 41 x 71 (sem adaptador primário)
Peso, com adaptador UE	48 g (sem pinos de conexão com a rede elétrica)
Aprovação, EMC	CE, FCC
Metros de altitude permitidos	5000 m
Nível de poluição	2

**Cuidado!**

Sujeito a modificações técnicas!
Para assegurar a máxima precisão dos resultados das medições,
utilizar sempre os acessórios e os reagentes fornecidos pelo
fabricante do instrumento.

9 Apêndice

9.1 Aviso de Direitos do Autor e Marca Registrada

Lovibond®, Tintometer® e T-CAL® são marcas registadas do grupo de empresas Tintometer®. Todas as traduções e transliterações de Lovibond® e Tintometer® são afirmadas como marcas registadas do grupo The Tintometer®.

A marca Bluetooth®, o logotipo e a marca combinada são marcas registadas e de propriedade da Bluetooth SIG e qualquer utilização pelo Grupo Tintometer® está sob licença.

Indice

	Pagina
1 Introduzione	206
1.1 Informazioni generali	206
1.1.1 Leggere le istruzioni prima dell'uso	206
1.1.2 Scopo del prodotto	206
1.1.3 Uso autorizzato	206
1.1.4 Requisiti per un uso sicuro	206
1.1.5 Mantenere le istruzioni	207
1.1.6 Qualificazione dell'utente	207
1.1.7 Manipolazione di prodotti chimici pericolosi	207
1.1.8 Istruzioni per lo smaltimento	207
1.2 Elenco di tutti i simboli usati nel documento	208
1.3 Abbreviazioni	208
2 Panoramica del prodotto	209
2.1 Certificazione	209
2.2 Caratteristiche	210
2.3 Descrizione del prodotto	210
2.4 Vista dello strumento	211
3 Commissioning	212
3.1 Ambiente operativo	212
3.2 Contenuto della consegna	212
3.3 Inserimento e sostituzione delle batterie	213
4 Operazione	215
4.1 Primo avvio	215
4.2 Principi generali di funzionamento	216
4.3 Elenco degli elementi di controllo e della loro funzione	217
4.3.1 Elenco degli elementi di controllo e della loro funzione	217
4.3.2 Elenco degli elementi di controllo e della loro funzione	218
4.3.3 Barra di stato	220
4.4 Misurazione	221
4.4.1 Panoramica della misurazione	221
4.4.2 Esecuzione di una misurazione	222
4.4.3 Suggerimenti per la misurazione	223
4.4.4 Impostazioni di misurazione	224
4.5 Descrizione delle singole fasi di lavoro o delle singole sezioni dell'interfaccia utente	225
4.5.1 Panoramica sulla calibrazione	225
4.5.2 Esecuzione di una calibrazione	225
4.5.3 Impostazioni di calibrazione	226

	Pagina
4.6 Verifica	228
4.6.1 Panoramica della verifica	228
4.6.2 Esecuzione di una verifica	228
4.6.3 Impostazioni di verifica	229
4.7 Registro	230
4.7.1 Selezione di un tipo di registro	230
4.7.2 Recuperare un registro	230
4.8 Impostazioni dello strumento	231
5 Manutenzione	234
5.1 Ricomincia il programma di manutenzione	234
6 Risoluzione dei problemi	236
6.1 Messaggi di errore e cosa fare	236
7 Accessori e parti di ricambio	238
7.1 Elenco degli accessori	238
7.2 Lista degli accessori	238
8 Specifiche	239
8.1 Specifiche - Adattatore di rete	241
9 Appendice	243
9.1 Avviso di copyright e marchio commerciale	243

1 Introduzione

1.1 Informazioni generali

1.1.1 Leggere le istruzioni prima dell'uso

Questo manuale fornisce informazioni importanti sul funzionamento sicuro del prodotto. Si prega di leggere attentamente questo manuale e di familiarizzare con il prodotto prima dell'uso.

1.1.2 Scopo del prodotto

Il turbidimetro portatile della serie TB è progettato per analizzare campioni acquosi che vengono raccolti in cuvette di vetro e poi sigillati. La cuvetta viene preparata per la misurazione utilizzando una tecnica accurata per ridurre al minimo l'interferenza di polvere e graffi. Dopo la preparazione, la cuvetta viene posta nello strumento per la misurazione.

Lo strumento può essere utilizzato in laboratorio o portato sul campo per effettuare misurazioni sui campioni mentre vengono raccolti.

Occorre prestare attenzione durante il trasporto di questo turbidimetro. Se lo strumento viene portato sul campo, si dovrebbe usare la valigetta di trasporto. Se lo strumento deve essere utilizzato per applicazioni regolamentari, è consigliabile contattare le autorità locali per assicurarsi che venga selezionato il modello di strumento corretto.

1.1.3 Uso autorizzato

La responsabilità del produttore e la garanzia per i danni sono annullate in caso di uso improprio, mancata osservanza del presente manuale, uso da parte di personale non qualificato o modifiche non autorizzate al prodotto.

Il produttore non è responsabile per costi o danni che sorgono dall'utente o da terzi a causa dell'uso di questo prodotto, specialmente in caso di uso improprio del prodotto o di uso improprio o di difetti nel collegamento del prodotto.

Il produttore non si assume alcuna responsabilità per errori di stampa.

1.1.4 Requisiti per un uso sicuro

Osservare i seguenti punti per un uso sicuro dell'unità:

- Se l'attrezzatura viene utilizzata in un modo non specificato dal produttore, la protezione fornita dall'attrezzatura può essere compromessa.
- Il prodotto può essere utilizzato solo in base all'uso autorizzato specificato sopra.
- Il prodotto può essere alimentato solo dalle fonti di energia menzionate in queste istruzioni per l'uso.
- Il prodotto può essere utilizzato solo nelle condizioni ambientali menzionate in queste istruzioni per l'uso.
- Il prodotto non deve essere aperto o modificato.

Il prodotto non deve essere utilizzato se:

- è visibilmente danneggiato (ad esempio dopo il trasporto)
- è stato conservato per un lungo periodo di tempo in condizioni avverse (condizioni di conservazione, vedi capitolo "Specifiche")

Presupposti per un uso sicuro dell'alimentatore a spina

Osservare i seguenti punti per un uso sicuro:

- Controllare che non ci siano danni visibili prima dell'uso. Se danneggiato, non mettere in funzione.
- Usare solo in stanze asciutte.
- Maneggiare solo con mani asciutte.
- Si può utilizzare solo l'alimentatore raccomandato dal produttore.
- Il prodotto non deve essere aperto o modificato.
- Solo il cavo USB-C raccomandato dal produttore può essere utilizzato per alimentare il dispositivo.

1.1.5 Mantenere le istruzioni

Il manuale deve essere tenuto nelle vicinanze del prodotto in modo da poter sempre trovare le informazioni necessarie.

1.1.6 Qualificazione dell'utente

Il personale operativo deve essere in grado di comprendere e applicare correttamente le etichette di sicurezza e le istruzioni di sicurezza sulle confezioni e sugli inserti dei prodotti.

L'utente deve essere capace e in grado di leggere e comprendere questo manuale per familiarizzare con la manipolazione e garantire un uso sicuro.

1.1.7 Manipolazione di prodotti chimici pericolosi

Pericoli chimici e/o biologici possono esistere dove viene usato questo prodotto. Rispettare tutte le leggi, i regolamenti e i protocolli in vigore quando si utilizza questo prodotto.

Nello sviluppo dei prodotti, Lovibond presta molta attenzione alla sicurezza. Alcuni pericoli derivanti da sostanze pericolose non possono essere evitati. Se si utilizzano test o soluzioni autoprodotte, la responsabilità di eventuali rischi causati da tali test o soluzioni è dell'utente (responsabilità personale).

Per la vostra protezione, per gli standard di torbidità superiori a 5 NTU, si raccomanda di indossare guanti o occhiali di protezione. Osservare la relativa scheda di sicurezza. Le schede di sicurezza dei prodotti chimici comprendono tutte le istruzioni sulla manipolazione sicura, i pericoli che si verificano, le azioni preventive e le azioni da intraprendere in situazioni pericolose.

1.1.8 Istruzioni per lo smaltimento

Smaltire le batterie e le apparecchiature elettriche in una struttura adeguata in conformità con la legislazione locale.

È illegale smaltire le batterie con i rifiuti domestici.

All'interno dell'Unione Europea, alla fine della vita del dispositivo, le batterie vengono smaltite in un punto di raccolta specializzato nel riciclaggio.



Gli strumenti contrassegnati da questo simbolo non devono essere smaltiti nei normali rifiuti domestici.

1.2 Elenco di tutti i simboli usati nel documento

IT

I seguenti simboli sono usati in questo manuale per indicare sezioni che richiedono un'attenzione speciale:



Pericolo!

C'è un pericolo che causerà la morte o lesioni gravi se non viene evitato!



Attenzione!

La manipolazione impropria di alcuni reagenti può danneggiare la tua salute. In ogni caso, seguite le informazioni sulle etichette di sicurezza sulla confezione, le istruzioni di sicurezza nel foglietto illustrativo e la scheda di sicurezza disponibile. Le misure di protezione ivi specificate devono essere seguite esattamente.



Attenzione!

Esiste un pericolo che può provocare lesioni lievi o moderate.

1.3 Abbreviazioni

Abbreviazioni	Definizione
NTU	Nephelometric Turbidity Unit
FNU	Formazin Nephelometric Units
mg/l	Milligrammo per litro

2 Panoramica del prodotto

2.1 Certificazione

EMC Emissioni condotte e irradiate	CISPR 11 (Limiti di classe A)	Marchio CE
Immunità EMC	EN 61326-1 (Limiti industriali)	Marchio CE
Sicurezza	EN 61010-1	TÜV marchio di sicurezza
FCC	FCC classe A	Marchio FCC

IT

Avviso FCC Classe A

Questo dispositivo è conforme alla parte 15 delle norme FCC. Il funzionamento è soggetto alle seguenti due condizioni:

- Questo dispositivo non può causare interferenze dannose.
- Questo dispositivo deve accettare qualsiasi interferenza ricevuta, incluse le interferenze che possono causare un funzionamento indesiderato.

Nota: Questa apparecchiatura è stata testata e trovata conforme ai limiti per un dispositivo digitale di Classe A, ai sensi della Parte 15 delle norme FCC. Questi limiti sono progettati per fornire una protezione ragionevole contro le interferenze dannose quando l'apparecchiatura viene utilizzata in un ambiente commerciale. Questa apparecchiatura genera, utilizza e può irradiare energia in radiofrequenza e, se non installata e utilizzata in conformità con il manuale di istruzioni, può causare interferenze dannose alle comunicazioni radio. Il funzionamento di questa apparecchiatura in un'area residenziale può causare interferenze dannose, nel qual caso l'utente sarà tenuto a correggere l'interferenza a proprie spese.

Cavi schermati



Le connessioni tra il sistema e le sue periferiche devono essere effettuate utilizzando cavi schermati al fine di mantenere la conformità con i limiti di emissione di radiofrequenza FCC.

Attenzione!

Modifiche



Qualsiasi modifica apportata a questo dispositivo che non sia stata approvata dalla Tintometer può annullare l'autorità concessa all'utente dalla FCC per utilizzare questa apparecchiatura.

Attenzione!

IT

Avviso DOC Classe A - Avis DOC, Classe A

Questo apparecchio digitale di classe A soddisfa tutti i requisiti delle norme canadesi sulle apparecchiature che causano interferenze.

2.2 Caratteristiche

L'accuratezza del laboratorio incontra la portabilità

La serie Lovibond® TB elimina le complessità nella misurazione della torbidità. Questa nuova tecnologia fornisce il massimo livello di accuratezza e di efficienza operativa e normativa.

- Interfaccia touchscreen per la facilità d'uso
- Istruzioni guidate da immagini per guidare l'utente attraverso le fasi del processo ed evitare errori.
- Semplici protocolli di gestione dei dati per garantire l'integrità dei dati

2.3 Descrizione del prodotto

La torbidità è un'espressione delle proprietà ottiche di un campione che fa sì che i raggi di luce vengano dispersi e assorbiti piuttosto che trasmessi in linea retta attraverso un campione fluido. In acqua, la torbidità è spesso causata dalla presenza di materia come argilla, limo, materia organica finemente divisa, plancton, altri organismi microscopici, acidi organici e pigmenti. La misurazione della torbidità è utilizzata per monitorare i processi che rimuovono o alterano le concentrazioni di particelle nelle soluzioni, come nella produzione di acqua potabile. Questi torbidimetri Lovibond® sono progettati per combinare l'alta precisione e l'alta sensibilità che ci si aspetta da un torbidimetro da laboratorio con la portabilità.

2.4 Vista dello strumento

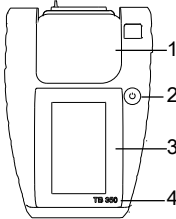
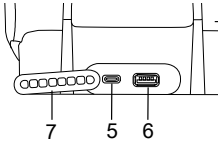
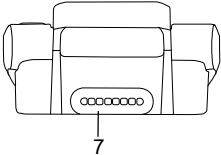
Posizione	Descrizione	Funzione
	1. Coperchio	Quando viene sollevato, permette all'utente di posizionare la cella del campione nello strumento per una lettura
	2. Pulsante di accensione	Accende e spegne lo strumento.
	3. Touch Screen	Visualizza l'interfaccia utente dello strumento.
	4. Numero di modello	Identifica la versione dello strumento.
	5. Porta USB-C	Fornisce alimentazione allo strumento da una fonte esterna o ricarica il pacco batterie accessorio (se installato).
	6. Porta USB-A	Supporta un dispositivo esterno USB-A per funzioni come il trasferimento di dati o il backup.
	7. Guarnizione	Utilizzato per coprire le porte USB quando le connessioni non sono in uso.

3 Commissioning

3.1 Ambiente operativo

Lo strumento può essere utilizzato in qualsiasi ambiente interno o esterno che sia ritenuto sicuro per un operatore per eseguire l'analisi.

Lo strumento può accettare campioni acquosi da 0 a 70 °C.

Lo strumento deve essere a livello $\pm 15^\circ$ quando si esegue una misurazione.

Lo strumento deve essere posizionato su una superficie piana per ottenere le migliori prestazioni di misurazione.

IT

3.2 Contenuto della consegna

Ispezionare attentamente tutti gli articoli per assicurarsi che ogni parte della lista sottostante sia presente e che non si siano verificati danni visibili durante la spedizione. Se c'è qualche danno o manca qualcosa, contattate immediatamente il vostro distributore locale.

TB	350 IR	350 WL
Strumento	X	X
Olio di silicone, 15 ml	X	X
Panno di microfibra	X	X
2 x Celle campione	X	X
Cacciavite	X	X
Spazzola	X	X
Custodia con inserto	X	X
Guida rapida	X	X
Certificato di conformità	X	X
Libretto di garanzia	X	X
4 batterie AA	X	X
Pacco batteria ricaricabile		
Cavo USB-C		
Alimentazione AC		
Adattatore per spine USA, Regno Unito e UE		
T-CAL® Standard, 5 NTU	X	X
T-CAL® Standard, 20 NTU	X	X
T-CAL® Standard, 800 NTU	X	X
T-CAL® Standard, 2000 NTU		X
T-CAL® Standard, 4000 NTU	X	X

3.3 Inserimento e sostituzione delle batterie

Quando si usano le batterie

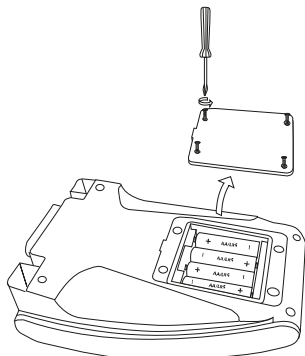

Passo	Descrizione
1	Usare un cacciavite per rimuovere le quattro viti sul retro dello strumento e rimuovere il pannello.
2	Inserire quattro batterie AA nell'orientamento corretto.
3	Fissare di nuovo il pannello sullo strumento.



Attenzione!

- Utilizzare solo il tipo approvato: batteria alcalina al manganese, LR6, con tensione di 1,5V.
- Rimuovere le batterie scariche dall'unità il prima possibile.
- Se l'unità non viene utilizzata per un lungo periodo, rimuovere le batterie dall'unità.

Quando si usano un pacco batterie ricaricabile

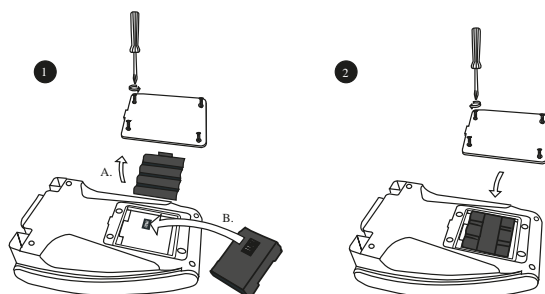

IT

Passo	Descrizione
1	Usare un cacciavite per rimuovere le quattro viti sul retro dello strumento, rimuovere il pannello e il vassoio delle batterie.
2	Inserire il pacco batterie ricaricabile nell'orientamento corretto.
3	Fissare di nuovo il pannello sullo strumento.



Attenzione!

L'accessorio un pacco batterie ricaricabile (19820-011) è compatibile solo con gli strumenti con numero di serie 23041000 e superiore.

L'uso del pacco batteria per strumenti con numero di serie precedente a 23041000 può causare il surriscaldamento del dispositivo durante la carica.

Questo surriscaldamento può causare letture errate e danni al dispositivo e deve quindi essere evitato.

Per gli strumenti con numero di serie inferiore a 23041000, contattare Lovibond® per informazioni sull'uso di questo accessorio.

4 Operazione

4.1 Primo avvio



1. Schermata di benvenuto

Schermata iniziale che l'utente vede alla prima accensione
Premere il pulsante >



2. Selezionare la lingua

Seleziona la lingua desiderata da impostare
Premere il pulsante >



3. Imposta data e ora

Scegliere tra il formato 12 e 24 ore
Cambia i valori usando le frecce su e giù
Premere il pulsante >



4. Password

Impostare una password selezionata dall'utente per implementare le funzioni di sicurezza sullo strumento
Premere il pulsante di salvataggio
Se non si desidera una password, selezionare Skip
Premere il pulsante >



5. Unità predefinite

Selezionare il tipo di unità desiderato da impostare
Premere il pulsante >



6. Dettagli del contatto

Inserisci le informazioni del proprietario dello strumento
Premere il pulsante di salvataggio
Se non si desidera nessun dettaglio, selezionare Skip
Premere il pulsante >



7. Schermata riassuntiva

Revisione dell'impostazione iniziale.
Premere < per cambiare l'impostazione prima di procedere
Premere > per procedere con la schermata iniziale
L'utente può selezionare l'attività da eseguire con lo strumento

4.2 Principi generali di funzionamento

I design dei turbidimetri portatili della serie TB sono suddivisi nei loro rispettivi componenti funzionali che vengono discussi in dettaglio. Questi includono la sorgente di luce, la trappola di luce diffusa a 90 gradi, il rivelatore di luce diffusa, la fiala del campione del turbidimetro e come questi componenti chiave lavorano insieme per fornire il risultato di torbidità.

IT

La configurazione ottica semplificata per la serie TB di turbidimetri portatili. Questa figura mostra il percorso della luce incidente e la vista del rivelatore di luce diffusa a 90°.

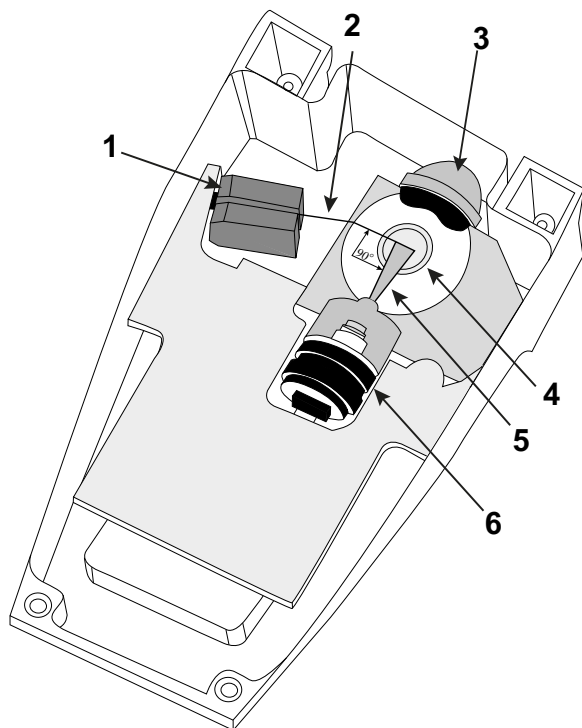





- 1 Illuminatore (LED e ottica)
- 2 Percorso della luce incidente
- 3 90° Trappola per luce parassita
- 4 Fiala del campione
- 5 Luce diffusa (10°-20° di vista del rivelatore)
- 6 Rivelatore di luce diffusa e ottica



4.3 Elenco degli elementi di controllo e della loro funzione

4.3.1 Elenco degli elementi di controllo e della loro funzione











Descrizione	Funzione
1 Barra di stato	Visualizza le icone e le etichette universali, tra cui Time, Bluetooth®, USB, Security, Light Source & Power.
2 Area d'azione	Area che visualizza i passi dell'applicazione e l'interazione.
3 Tasto Home	Usato principalmente per la navigazione, per iniziare o salvare o chiudere le azioni e tornare a casa.

Icona	Descrizione
	Modalità di misurazione
	Modalità di calibrazione
	Modalità di verifica
	Registri di dati

Icona	Descrizione
	Connessione Bluetooth al turbidimetro di processo PTV (non disponibile per TB 350)
	Impostazioni dello strumento

IT

4.3.2 Elenco degli elementi di controllo e della loro funzione









Icona	Descrizione	Funzione
	Nome dell'applicazione	Titolo dell'app che l'utente sta attualmente utilizzando.
	Tempo	Ora impostata dall'utente nella configurazione iniziale o accedendo alle impostazioni dello strumento. È disponibile il formato 12 ore o 24 ore.
	USB	Se visualizzato, indica che un modulo USB è collegato all'unità.
	Icona Bluetooth - Pianura ²⁾	Se visualizzato, il modulo Bluetooth® è collegato.
	Icona Bluetooth - Con frecce ²⁾	Se visualizzato, il modulo Bluetooth® è collegato e sta comunicando attivamente con un PTV o un'App AquaLX.
	Sorgente di luce rossa - riempita	Lo strumento contiene una fonte di luce LED rossa; la luce è accesa per la misurazione.
	Sorgente di luce rossa - Schema	Lo strumento contiene una fonte di luce LED rossa; nessuna misurazione è attiva.
	Sorgente di luce bianca - riempita	Lo strumento contiene una fonte di luce LED bianca; la luce è accesa per la misurazione.
	Sorgente di luce bianca - Schema	Lo strumento contiene una fonte di luce LED bianca; nessuna misurazione è attiva.



Icona	Descrizione	Funzione
	Sorgente di luce infrarossa - On	Lo strumento contiene una fonte di luce LED a infrarossi; la luce è accesa per la misurazione.
	Sorgente di luce infrarossa - Off	Lo strumento contiene una fonte di luce LED a infrarossi; nessuna misurazione è attiva.
	Sorgente di luce laser - Riempita ¹⁾	Lo strumento contiene una fonte di luce laser LED; la luce è accesa per la misurazione.
	Sorgente di luce laser - Schema ¹⁾	Lo strumento contiene una fonte di luce laser LED; nessuna misurazione è attiva.
	Carica della batteria AC	La batteria AC è in carica.
	Icona AC Power	Indica che lo strumento è alimentato tramite l'alimentazione CA.
	Alimentazione a batteria - Verde	Indica che rimane il 100% della vita della batteria.
	Alimentazione a batteria - Giallo	Indica che rimane il 75% della durata della batteria.
	Alimentazione a batteria - Arancione	Indica che rimane il 50% della durata della batteria.
	Alimentazione a batteria - Rosso	Indica che rimane il 25% della durata della batteria.
	Coperchio del pozzetto di misurazione aperto	Indica che il coperchio del pozzetto di misurazione è aperto.
	Coperchio del pozzetto di misurazione chiuso	Indica che il coperchio del pozzetto di misurazione è chiuso.

¹⁾ solo TB 600

2) non TB 350

4.3.3 Barra di stato

Icona	Descrizione	Funzione
	Tasto Home	Riporta l'utente alla schermata iniziale.
	Tasto Home - Bloccato	La sicurezza è attiva; la password è stata abilitata ed è necessaria per eseguire alcune funzioni.
	Tasto Home - Sbloccato	La sicurezza è inattiva; nessuna funzione è bloccata all'utente.
	Tasto Salva	Salva il contenuto visualizzato nell'area attiva.
	Tasto Impostazioni	Apri il menu di impostazione di un'applicazione.
	Tasto Esportazione	Esporta il log visualizzato nell'area attiva.
	Tasto di misurazione	Avvia o inizia una misurazione.
	Tasto di misurazione – con Bluetooth ⁽²⁾	Esegue una misurazione mentre è collegato a un'unità PTV.
	Bluetooth® Tasto di aggiornamento ²⁾	Aggiorna l'elenco delle unità PTV disponibili in prossimità dello strumento.

Icona	Descrizione	Funzione
	Tasto Annulla	Dà l'opzione di cancellare l'attività corrente nell'area attiva.
	Chevron di destra	Avanzare al passo successivo all'interno di un processo.
	Chevron sinistro	Ritorna a un passo precedente all'interno di un processo.

²⁾ non TB350

4.4 Misurazione

4.4.1 Panoramica della misurazione

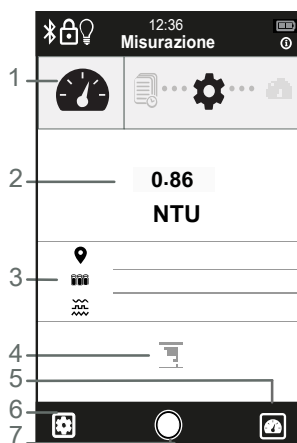

Descrizione	Funzione
1 Barra delle applicazioni	Percorso di navigazione per guidare l'utente attraverso i passi del processo.
2 Valore di misurazione	Visualizzazione del valore del campione misurato con il tipo di unità.
3 Impostazioni	Vengono visualizzate le impostazioni applicate alla misurazione.
4 Pulsante Log	Crea un registro quando viene premuto.
5 Pulsante di misurazione	Avvia una misurazione quando viene premuto.

Descrizione	Funzione
6 Pulsante Impostazioni	Usato per cambiare le impostazioni.
7 Pulsante Home	Riporta l'utente alla schermata iniziale.

4.4.2 Esecuzione di una misurazione

IT

Si prega di preparare le celle campione incluse nella fornitura prima della misurazione. Assicurarsi che le celle campione siano prive di macchie, graffi o imperfezioni.

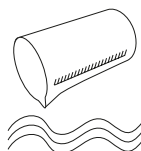

1. Raccogliere il campione

Assicurarsi che il campione sia rappresentativo (ben mescolato). La vetreria deve essere priva di macchie, graffi o altri difetti. Sciacquare il recipiente di raccolta almeno due volte con il campione prima di raccoglierlo.



2. Preparare la cuvetta

Usando un panno privo di lanugine, asciugare l'esterno della cuvetta del campione. Utilizzare olio di silicone per ridurre al minimo i riflessi di luce parassita.



3. Inserire la cuvetta nello strumento

Assicurarsi che il campione sia privo di bolle. Invertire lentamente per miscelare. Non agitare.



4. Chiudere il coperchio

La misurazione non sarà consentita senza il coperchio.



5. Controllare le impostazioni

Assicurarsi che le impostazioni di misurazione siano corrette. Le impostazioni per la misurazione non possono essere cambiate dopo la misurazione.



6. Premere il pulsante Misura

Inizia la misurazione.



7. Registro dati

Inserire "Registro dati" per salvare la misurazione.



8. Salvare la misurazione

Se lo si desidera, premere il pulsante Save (Salva) per creare un registro di misurazione.



9. Pausa

Mette in pausa la misurazione in modalità di misurazione "continuo".



- Non portare alcun oggetto nella camera di misurazione, tranne le cuvette destinate alle misurazioni.
- Non portare liquidi nella camera.

Attenzione!

4.4.3 Suggerimenti per la misurazione

Indicizzazione della cuvetta: questa operazione viene eseguita al meglio con una cuvetta riempita d'acqua filtrata attraverso un filtro da 0,2 µm.

- Premere il pulsante di misurazione.
- Ruotare il campione. Mentre si ruota la cuvetta, identificare la lettura più bassa.
- Quando la posizione è determinata, arrestare la misurazione. Contrassegnare la cuvetta.
- Prima di procedere con ulteriori misurazioni, assicurarsi che la modalità di misurazione sia aggiornata, se necessario.
- Si consiglia di indicizzare la cuvetta del campione se è presente un graffio o una fossa evidente nella vetreria.

Uso dell'olio di silicone

- Fare attenzione a maneggiare la cuvetta solo per il terzo superiore.
- Pulire la cuvetta con il panno di pulizia in dotazione per rimuovere acqua, polvere e impronte digitali.
- Oliare l'esterno della fiala con olio di silicone.
 - Posizionare una perlina molto sottile di olio di silicone lungo il lato della cuvetta. Distribuire uniformemente il cordone di olio sui 2/3 inferiori della fiala.
 - Pulire il silicone dalla cuvetta ruotando la cuvetta contro un panno pulito e privo di polvere.
- L'oliatura delle cuvette è fondamentale e consigliata quando si misurano campioni con una torbidità prevista inferiore a 0,5 NTU.

Campioni contenenti bolle in eccesso

- Lasciare riposare il campione per almeno cinque minuti.
- Capovolgere delicatamente il campione due o tre volte per risospingere la torbidità.
- Posizionare nello strumento e procedere come da istruzioni.

Altre note

- L'uso di bagni ad ultrasuoni non è raccomandato. L'energia ultrasonica può cambiare la distribuzione delle particelle.
- Utilizzare la modalità Fast Setting per i campioni che hanno alte concentrazioni di sabbie o particelle ad alta densità.

4.4.4 Impostazioni di misurazione

IT



Premere il pulsante Impostazioni per accedere alla modalità Impostazioni di misurazione.

Icona	Descrizione	Opzione	Funzione
	Modalità	Singolo	Spingere a leggere.
		Continuo ¹⁾	La misurazione si aggiorna ogni X secondi fino all'arresto.
		Fast Settling	Raccomandato per campioni con caratteristiche di sedimentazione rapida.
	Località	Predefinito	Usato se non è impostato alcun ID personalizzato.
		Personalizzato	Descrizione personalizzata del luogo di misurazione e dei limiti di misurazione.
	Media del segnale	Su	Se attivato, può essere impostato fino a 255 misure. La funzione dovrebbe essere utilizzata se le misurazioni sono instabili.
		Spento	Disattivato
	ID campione	Impostazione predefinita	Usato se non è impostato alcun ID personalizzato.
		Personalizzato	Identificatore unico del campione; selezionabile dall'utente.

¹⁾ non TB350

4.5 Descrizione delle singole fasi di lavoro o delle singole sezioni dell'interfaccia utente

4.5.1 Panoramica sulla calibrazione

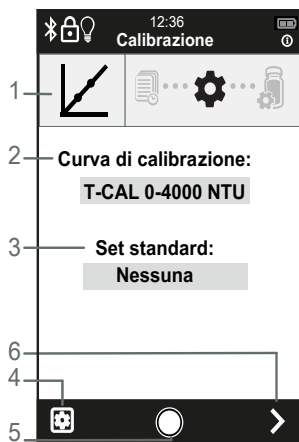

Descrizione	Funzione
1 Barra delle applicazioni	Percorso di navigazione per guidare l'utente attraverso i passi del processo.
2 Curva di calibrazione	Specifica il tipo di calibrazione.
3 Set standard	Identificatore unico dell'insieme standard.
4 Pulsante Impostazioni	Usato per cambiare le impostazioni.
5 Pulsante Home	Riporta l'utente alla schermata iniziale.
6 Pulsante successivo	Passa alla schermata successiva.

4.5.2 Esecuzione di una calibrazione

Si prega di preparare gli standard T-CAL® inclusi nella fornitura prima della calibrazione. Assicurarsi che le fiale T-CAL® siano prive di macchie, graffi o imperfezioni.

- Standard T-CAL® per TB 350 IR: 20 / 800 / 4000 NTU
- Standard T-CAL® per TB 350 WL: 20 / 800 / 2000 / 4000 NTU

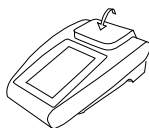

- 1. Regolazione dello zero:**
Esegui una regolazione dello zero.

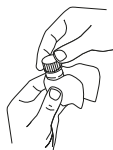

- 2. Preparare la cuvetta:**
Oliare la cuvetta del campione, se necessario.



- 3. Inserire lo standard nell'unità:**
Inserire lo standard indicato sullo schermo.
L'utente inserirà una serie di vari standard di torbidità per completare la calibrazione.



- 4. Azione:**
Sta per un processo attivo.



- 5. Riassunto del log:**
Premere il pulsante Save (Salva) per salvare il giornale.
Premere il pulsante Annulla per tornare all'inizio del processo di calibrazione.

4.5.3 Impostazioni di calibrazione



Premere il pulsante Impostazioni per accedere alla modalità impostazioni.

Icona	Descrizione	Opzione	Funzione
	Curva di calibrazione	T-CAL®	Seleziona lo standard di formazina stabilizzata preparato a concentrazioni predefinite
		Formazina utente	Seleziona lo standard di formazina preparato dall'utente a concentrazioni predefinite
	Set standard	Predefinito	Usato se non è impostato un identificatore unico.
		Unica	Identificatore unico dell'insieme standard.

**Promemoria¹⁾**

Su Ricorda all'utente che la calibrazione è dovuta.
Opzione per forzare la calibrazione prima di ulteriori misurazioni.

Spento Impostazione predefinita.

**Calibrazione predefinita**

Opzione per tornare all'impostazione di calibrazione di fabbrica.

**Verifica per posta**

Su Richiede all'utente di eseguire una verifica dopo il completamento della calibrazione.

Spento Impostazione predefinita.

**“Controllo calibrazione”**

Su (Predefinito) Durante la procedura di calibrazione, se un singolo standard è fuori tolleranza, l'utente deve correggere lo standard per procedere o annullare la procedura di calibrazione. Questa funzione impedisce all'utente di commettere un errore di calibrazione a causa di uno standard errato. La schermata di registro avrà una voce di riga per Calibration Checker e mostrerà uno stato "On" o "Enabled".

Spendo Durante la procedura di calibrazione, se un singolo standard è fuori tolleranza, l'utente non sarà avvisato che un calibratore è fuori dal range predefinito di Tintometri. La schermata di registro avrà una voce di riga per Calibration Checker e mostrerà uno stato "Off" o "Disabled".

¹⁾ non TB350

4.6 Verifica

4.6.1 Panoramica della verifica

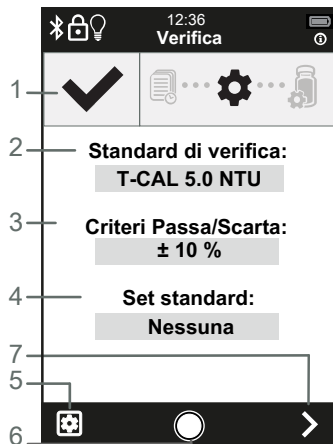

Descrizione	Funzione
1 Barra delle applicazioni	Percorso di navigazione per guidare l'utente attraverso i passi del processo.
2 Standard di verifica	Valore dello standard da misurare.
3 Passato / Fallito	Tolleranza usata per determinare se una verifica passa o fallisce.
4 Set standard	Identificatore unico dell'insieme standard.
5 Pulsante Impostazioni	Usato per cambiare le impostazioni.
6 Pulsante Home	Riporta l'utente alla schermata iniziale.
7 Pulsante successivo	Passa alla schermata successiva.

4.6.2 Esecuzione di una verifica



1. Preparare la fiala

Oliate la fiala del campione, se necessario.



3. Inserisci standard

Inserire il valore standard specificato sullo schermo.



4. Modale

Rappresenta il processo attivo.



5. Riassunto del registro

Premere il pulsante Salva per salvare il registro.

Premere il pulsante Annulla per tornare all'inizio del processo di verifica.

IT

4.6.3 Impostazioni di verifica



Premere il pulsante Impostazioni per entrare nella modalità impostazioni.

Icona	Descrizione	Opzione	Funzione
	Standard	T-CAL 5.0 NTU	Seleziona lo standard di formazina stabilizzata preparato alla concentrazione di 5,0 NTU.
		Preparato dall'utente	Seleziona lo standard preparato dall'utente tra 1 e 1000 NTU.
	Criteri Pass/Fail	±10%	Tolerance used for determining if a verification passes or fails.
		± 5%	
		±0.05 NTU	
		±0.10 NTU	
	Promemoria¹⁾	Su	Ricorda all'utente che la verifica è dovuta.
		Spento	Impostazione predefinita.

¹⁾ non TB350

4.7 Registro

4.7.1 Selezione di un tipo di registro



Premi il pulsante Tipo di registro nell'Area di azione per accedere ai registri.

Barra di applicazione:



Registri delle misurazioni:

Visualizza tutte le misurazioni registrate.



Registri di calibrazione:

Visualizza tutte le registrazioni di calibrazione.



Registri di verifica:

Visualizza tutte le registrazioni di verifica.



Registri del modo GLP:

Visualizza la registrazione della modalità GLP attivata o disattivata.

¹⁾ non TB 350

4.7.2 Recuperare un registro



1. Selezionare il tipo di registro

Visualizza i record del tipo di registro che l'utente desidera visualizzare.



2. Esportazione di singoli registri

Se viene selezionato un singolo record, quel registro viene esportato in formato CSV.

Tutti i dettagli associati ai log vengono esportati.



3. selezionare il metodo di trasferimento

USB: Esporta il protocollo su una memoria USB.



Bluetooth[®]¹⁾: Esporta il registro all'applicazione mobile AquaLX.

Non disponibile su TB 350.



Nota: un dongle esterno Lovibond[®] Bluetooth[®] è necessario per la connessione alla porta USB-A.

¹⁾ non TB 350

4.8 Impostazioni dello strumento



Premere il pulsante Impostazioni per accedere alla modalità Impostazioni.

Icona	Descrizione	Opzione	Funzione
	Sicurezza	Attivare	Impostare, verificare e cambiare la password.
		Disabilita	Impostazione predefinita.
	Impostazioni di potenza	Luminosità dello schermo	Regolare la luminosità dello schermo.
		Spegnimento della retroilluminazione	Off 20 secondi 30 secondi 1 minuto* 5 minuti
		Spegnimento del sistema	Off 1 minuto 2 minuti 5 minuti 15 minuti* Nota: Quando si utilizza il cavo di alimentazione USB-C, lo spegnimento del sistema è impostato su "Off" fino a quando l'unità viene scollegata e poi ritorna all'opzione selezionata.
	Bluetooth ¹⁾	Attivare	Abilita il Bluetooth® quando è presente l'hardware.
		Disabilita	Impostazione predefinita.

IT

**Scorciatoie
USB¹⁾**

Attivare

Se abilitato, quando un dispositivo di archiviazione USB è collegato, l'utente viene presentato con un modale che presenta un'opzione per le impostazioni di "trasferimento dei log" o "backup/ripristino". Selezionando un'opzione, l'utente viene indirizzato alla funzione appropriata.

Disabilita

Impostazione predefinita; gli utenti devono accedere alle impostazioni "Logs" o "Backup/Restore" quando il dispositivo di archiviazione USB è collegato.

Lingua

Selezionare la lingua.

Data/ora

Selezionare l'ora visualizzata e il formato.

**Backup /
Ripristino**
Backup di tutte le impostazioni¹⁾

Opzione per memorizzare le impostazioni sulla scheda SD locale o salvare su un'unità USB esterna.

Ripristina tutte le impostazioni¹⁾

Recupera le impostazioni precedentemente salvate sulla scheda SD locale o su un'unità USB esterna.

Ripristinare le impostazioni di fabbrica

Ripristina tutte le impostazioni ai valori di fabbrica. I registri salvati sono ancora disponibili.

**Unità**

NTU	Selezionare l'unità visualizzata.
FNU	Definisce il tipo di unità del valore di misurazione visualizzato.
mg.l Kaolin	NTU è l'impostazione predefinita.
mg.l PSL	
Gradi	
mNTU ¹⁾	
mFNU ¹⁾	
Personalizzato ¹⁾	Permettere un tipo di unità definito dall'utente e la possibilità di impostare un fattore basato sui valori NTU/FNU.

**GLP¹⁾**

Attivare	Stabilisce un protocollo per l'integrità dei dati per i laboratori che seguono le buone pratiche di laboratorio.
Disabilita	Impostazione predefinita.

**Proprietario**

Dati di contatto del proprietario dello strumento.

**Contatto**

Dati di contatto del proprietario dello strumento. Informazioni di contatto per gli uffici Lovibond®.

**Informazioni su**

Informazioni su Lovibond®.

¹⁾ non TB 350

* Impostazione predefinita

5 Manutenzione

5.1 Ricomincia il programma di manutenzione

Compito.	Fare	Non fare
1. Camera di misura pulita 2. Pulire il display dello strumento	<ol style="list-style-type: none"> Assicurarsi che la camera di misurazione sia pulita e asciutta prima della misurazione. Usare un panno in microfibra asciutto per rimuovere le impurità. Pulire il touchscreen con un panno in microfibra asciutto o leggermente umido. 	<ol style="list-style-type: none"> Spruzzare o versare qualsiasi liquido direttamente nella camera di misurazione. Misurare un campione che non sia ben tappato.
Pulire l'alloggiamento esterno	Pulire l'involucro esterno con una soluzione detergente delicata o con alcool diluito.	
Conservazione e cura delle cellule del campione	Sciquare sempre le fiale con acqua priva di torbidità dopo l'uso.	Utilizzare l'olio di silicone in eccesso che non è stato ripulito dalla fiala. Una singola perla è tutto ciò che è necessario.
	Riempire la fiala con acqua DI. Tappare la fiala per evitare la formazione di macchie d'acqua.	Lasciare le celle del campione scoperte ad asciugare all'aria.
	Asciugare l'esterno della fiala con un panno in microfibra.	Utilizzare qualsiasi fiala che abbia imperfezioni visibili, compresi buchi, graffi o crepe.
Sostituzione della batteria	Si suggerisce di rimuovere le batterie se lo strumento viene conservato per più di 30 giorni per evitare perdite dalla batteria.	Usa un tipo di batteria non specificato.
Calibrazione	<p>Calibrare come necessario nelle seguenti condizioni:</p> <ol style="list-style-type: none"> Errore di verifica. Si esegue la manutenzione dei sistemi ottici o elettronici. Come richiesto dalle autorità regionali di regolamentazione. 	Utilizzare standard scaduti.
	Seguire attentamente le istruzioni per la preparazione e l'uso degli standard.	

Compito.	Fare	Non fare
Verifica	<p>Verificare le prestazioni dello strumento nelle seguenti condizioni:</p> <ol style="list-style-type: none"> 1. Dopo aver eseguito una calibrazione. 2. Secondo le procedure interne di controllo della qualità. 3. Come richiesto dalle autorità regionali di regolamentazione. 	Utilizzare standard scaduti.
	Seguire attentamente le istruzioni per la preparazione e l'uso degli standard.	
Connettore / Guarnizione	Assicurarsi che la guarnizione del connettore sia attaccata quando non è in un ambiente di laboratorio.	<p>Non immagazzinare l'unità senza la guarnizione collegata.</p> <p>Trasportare o sostenere lo strumento tramite un cavo di collegamento.</p>

**Attenzione!**

La manipolazione impropria di alcuni reagenti può danneggiare la tua salute. In ogni caso, seguite le informazioni sulle etichette di sicurezza sulla confezione, le istruzioni di sicurezza nel foglietto illustrativo e la scheda di sicurezza disponibile. Le misure di protezione ivi specificate devono essere seguite esattamente.

6 Risoluzione dei problemi

6.1 Messaggi di errore e cosa fare

Sintomo	Possibile causa	Soluzione
Sopra la gamma	La torbidità del campione è oltre il campo di misura dello strumento.	<ul style="list-style-type: none"> Diluire il campione Verificare la calibrazione utilizzando uno standard di alta gamma.
Sotto gamma	La torbidità del campione è inferiore al limite di rilevamento dello strumento.	<ul style="list-style-type: none"> Ripetere la misurazione della luce diffusa (regolazione dello zero) come prescritto e assicurarsi che il coperchio del campione sia chiuso. Ripetere la calibrazione dopo aver determinato la luce parassita.
Lo strumento non si accende	Le batterie sono difettose Le batterie non sono inserite correttamente	<ul style="list-style-type: none"> Sostituire le batterie con un set completo nuovo.
Il pulsante "Salva" per una funzione non appare, quindi non è possibile creare un registro.	Mancano le informazioni richieste	Assicuratevi che le iniziali dell'utente e tutti gli altri campi richiesti siano indirizzati correttamente.
Lo strumento non esegue la misurazione	Il coperchio non è chiuso	Chiudere il coperchio.
Notifica di batteria scarica	La batteria è al di sotto del 20%.	Sostituire o ricaricare le batterie
Le impostazioni dello strumento non sono accessibili all'utente	Il protocollo di sicurezza del dispositivo è attivo	Inserite la password per sbloccare le funzioni di impostazione e calibratura
Errore di calibrazione	Le fiale dei campioni non sono state pulite prima della calibrazione	<ul style="list-style-type: none"> Lavare nuovamente le fiale del campione seguendo la procedura indicata nel manuale. Conservare le fiale come prescritto nel manuale. Controllare la data di scadenza dello standard
Errore di calibrazione	Gli standard di calibrazione sono stati eseguiti nell'ordine sbagliato	Ripetere la calibrazione con gli standard dal valore più basso a quello più alto.

Sintomo	Possibile causa	Soluzione
Errore di calibrazione	Gli standard di calibrazione non erano adeguatamente miscelati.	Miscelare gli standard come indicato immediatamente prima di eseguire la calibrazione.
Errore di calibrazione	Standard di calibrazione preparati per valori di torbidità errati	Ripetere la preparazione degli standard di calibrazione, assicurandosi che le diluizioni siano corrette.
Errore di verifica	La verifica cade fuori dai confini dell'errore	<ul style="list-style-type: none"> • Mescolare lo standard di verifica prima della verifica. • Controllare i criteri pass/fail per assicurarsi che i criteri non siano più stretti della precisione dello standard e regolare questi criteri di conseguenza. • Controllare la data di scadenza dello standard

7 Accessori e parti di ricambio

7.1 Elenco degli accessori

Titolo		N. ordine
Alimentatore TB series	TB350 IR, TB350 WL	19820-170
Batterie (AA), set da 4	TB350 IR, TB350 WL	1950025
Cavo USB-C 1 m, da USB-C a A	TB350 IR, TB350 WL	19820-081
Cuvette di misura con coperchio nero, altezza 55 mm, ø 24 mm, set da 12	TB350 IR, TB350 WL	197655
Olio di silicone	TB350 IR, TB350 WL	194295
Panno per la pulizia	TB350 IR, TB350 WL	197635
Rechargeable battery pack, Ni-MH	TB350 IR, TB350 WL	19820-011
Set di norme di torbidità T-CAL (5, 20, 800, 2000, 4000 NTU)	TB350 WL	194152
Set di norme di torbidità T-CAL (5, 20, 800, 4000 NTU)	TB350 IR	194154
Spazzola, lunghezza 11 cm	TB350 IR, TB350 WL	380230
Supporto per 6 cuvette rotonde ø 24 mm	TB350 IR, TB350 WL	418951
T-CAL®-Standard, 4000 NTU, 125 ml	TB350 IR, TB350 WL	48012912
T-CAL®-Standard, 4000 NTU, 500 ml	TB350 IR, TB350 WL	48012950

7.2 Lista degli accessori

Description	Numero di parte
Valigetta da trasporto	19820-130
Coperchio, camera del campione	19820-095
Coperchio, vano batteria	19820-098
Tappo, elastomero, IP67, I/O	19820-084
Insero per 4 batterie AA	19820-012

8 Specifiche

Model	Model WM-040-1004 (IR) Model WM-040-1001 (WL)
Sorgente luminosa	LED infrarossi (860 nm) LED bianco
Conformità normativa	ISO 7027 Approvato dall'EPA (in alternativa a US EPA 180.1)
Principio di misura	Nefelometrica (Multipath 90° BLAC)
Campo di misura	0,01 - 4000 NTU (FNU)
Precisione del valore misurato	Autoranging: 0.01-9.99: 0.01 NTU ; 10.0-99.9: 0.1 NTU ; 100-4000: 1 NTU
Precisione	± 1,8 % della lettura + luce parassita
Ripetibilità	< 1% o ± 0,01 NTU
Luce diffusa	< 0.014 NTU
Unità visualizzata	NTU, FNU, gradi, mg/L Kaolin, mg/L PSL
Tempo di reazione	7 secondi
Modalità di lettura	Singolo, media del segnale, Fast-Settling
Opzioni di calibrazione	Calibrazione completa da 0 - 4000 NTU
Rilevatore	Fotodiodo di silicio
Modalità di ratio	Si
Volume del campione richiesto	10 mL (0,4 oz)
Display	Touchscreen a colori
Dimensione del display	55 x 95 mm (L x A)
Interfacce	<ul style="list-style-type: none"> • USB-A • USB-C
Registratore di dati	250 misure, tutte le calibrazioni, le verifiche e i ripristini di fabbrica
Formato di trasferimento dati	.csv
Modalità di risparmio energetico	Si

Auto – OFF	Selezionabile
Alimentazione elettrica	<ul style="list-style-type: none"> • 3 NiMH-battery pack (AA) • 4 batteries (AA) • Universal (90 - 240 VAC), via external power supply
Condizioni ambientali	<p>Temperatura: 0 - 50 °C (32 - 122 °F)</p> <p>Umidità: 0 - 90 % a 30 °C, senza condensa</p> <p>Umidità: 0 - 80 % a 40 °C (104 °F), senza condensa</p> <p>Umidità: 0 - 70 % a 60 °C, senza condensa</p>
Classe di protezione	IP 67 (strumento)
Conformità	<ul style="list-style-type: none"> • CE • CSA • FCC A • RoHS • TÜV • UL • WEE
Lingue dell'interfaccia utente	<ul style="list-style-type: none"> • Cinese • Francese • Giapponese • Inglese • Olandese • Polacco • Portoghese • Spagnolo • Tedesco • Turco
Lingue della guida rapida	<ul style="list-style-type: none"> • Cinese • Francese • Inglese • Italiano • Olandese • Portoghese • Russo • Spagnolo • Tedesco • Turco

Lingue del manuale operativo	<ul style="list-style-type: none"> • Cinese • Francese • Inglese • Italiano • Olandese • Portoghese • Russo • Spagnolo • Tedesco • Turco
Dimensioni	155 x 83 x 225 mm
Peso	804 g (898 g with four AA alkaline batteries)
Peso con imballaggio	(898 g with four AA alkaline batteries)

**Attenzione!**

Con riserva di modifiche tecniche!
Per garantire la massima precisione dei risultati dei test, utilizzare sempre i sistemi di reagenti forniti dal produttore dello strumento.

8.1 Specifiche - Adattatore di rete

Tipo	WR9QA2500USB52NMR6B
Design	Spina dell'adattatore di rete, alimentazione switching
Tensione d'ingresso, frequenza	100 – 240 V \pm 10 %, 50 / 60 Hz \pm 5 %
Corrente d'ingresso	0,3 A
Adattatore primario	Europa, Regno Unito, Australia, USA
Classe di protezione	II
Tensione di uscita, frequenza	5,2 V, DC
Corrente d'uscita massima	2,5 A
Protezione dell'uscita	Spegnimento dell'uscita e riavvio automatico
Condizioni ambientali	Da 0 °C a 40 °C, con max. 95 % di umidità relativa dell'aria
Classe di efficienza energetica	VI
Standard di sicurezza	EN 62368
EMC	EN 55032 FCC Part 15 Class A EN 55024

Tipo	WR9QA2500USB52NMR6B
Dimensioni [mm]	31,5 x 41 x 71 (senza adattatore primario)
Peso, con adattatore EU	48 g (senza lame dell'adattatore primario)
Approvazione, EMC	CE, FCC
Metri di altitudine consentita	5000 m
Livello di inquinamento	2

IT

**Attenzione!**

Con riserva di modifiche tecniche!

Per garantire la massima precisione dei risultati dei test, utilizzare sempre i sistemi di reagenti forniti dal produttore dello strumento.

9 Appendice

9.1 Avviso di copyright e marchio commerciale

Lovibond®, Tintometer® e T-CAL® sono marchi registrati del gruppo Tintometer. Tutte le traduzioni e traslitterazioni di Lovibond® e Tintometer® sono affermati come marchi commerciali del gruppo Tintometer®.

Il marchio Bluetooth®, il marchio di figure e il marchio combinato sono marchi di proprietà di Bluetooth SIG e qualsiasi uso da parte del Gruppo Tintometer® è sotto licenza.

Inhoudsopgave

NL

	Zijde
1 Inleiding	246
1.1 Algemene informatie	246
1.1.1 Belangrijke opmerking	246
1.1.2 Doel van het product	246
1.1.3 Beoogd gebruik	246
1.1.4 Eisen voor veilig gebruik	246
1.1.5 Instructies bewaren	247
1.1.6 Kwalificatie van de gebruiker	247
1.1.7 Hantering van gevaarlijke chemicaliën	247
1.1.8 Instructies voor afvoer	247
1.2 Lijst van alle in het document gebruikte symbolen	248
1.3 Afkortingen	248
2 Product overzicht	249
2.1 Certificering	249
2.2 Kenmerken	250
2.3 Beschrijving van het product	250
2.4 Aanzicht instrument	251
3 In bedrijf name	252
3.1 Gebruiksomgeving	252
3.2 Inhoud van de levering	252
3.3 Plaatsen en vervangen van batterijen	253
4 Bediening	255
4.1 Eerste opstart	255
4.2 Algemene werkingsprincipes	256
4.3 Lijst van bedieningsorganen en hun functie	257
4.3.1 Lijst van bedieningsorganen en hun functie	257
4.3.2 Lijst van bedieningsorganen en hun functie	258
4.3.3 Statusbalk	260
4.4 Meting	261
4.4.1 Weergave van de meetresultaten	261
4.4.2 Een meting uitvoeren	262
4.4.3 Tips voor metingen	263
4.4.4 Meting Instellingen	264
4.5 Kalibratie	265
4.5.1 Uitlezing van de kalibratie	265
4.5.2 Een kalibratie uitvoeren	265
4.5.3 Kalibratie-instellingen	266

	Zijde
4.6 Verificatie	267
4.6.1 Verificatie Overzicht	267
4.6.2 Een verificatie uitvoeren	268
4.6.3 Verificatie-instellingen	269
4.7 Logboeken	269
4.7.1 Het selecteren van een log type	269
4.7.2 Een logboek ophalen	270
4.8 Instrument Instellingen	270
5 Onderhoud	274
5.1 Aanbevolen onderhoudsschema	274
6 Probleemoplossing	276
6.1 Foutmeldingen en wat te doen	276
7 Accessoires en vervangingsonderdelen	278
7.1 Lijst van accessoires	278
7.2 Lijst van accessoires	278
8 Specificaties	279
8.1 Specificaties - Netadapter	281
9 Aanhangsel	283
9.1 Copyright en handelsmerk kennisgeving	283

1 Inleiding

1.1 Algemene informatie

1.1.1 Belangrijke opmerking

Deze handleiding bevat belangrijke informatie over de veilige bediening van het product. Lees deze handleiding zorgvuldig door en maak u vertrouwd met het product voordat u het gebruikt.

1.1.2 Doel van het product

De draagbare troebelheidsmeter van de TB-serie is ontworpen voor de analyse van waterige monsters die in glazen cuvetten worden verzameld die vervolgens worden afgesloten. De cuvet wordt voor de meting geprepareerd met een zorgvuldige techniek om interferentie van stof en krassen tot een minimum te beperken. Na de voorbereiding wordt de cuvet in het instrument geplaatst voor de meting.

Het instrument kan worden gebruikt in het laboratorium of op locatie om metingen te verrichten op monsters die worden verzameld.

Wees voorzichtig bij het vervoer van deze troebelheidsmeter. Als het instrument wordt meegenomen in het veld, moet de draagkoffer worden gebruikt. Indien het instrument moet worden gebruikt voor geregementeerde toepassingen, is het raadzaam contact op te nemen met de plaatselijke autoriteiten om er zeker van te zijn dat het juiste instrumentmodel is gekozen.

1.1.3 Beoogd gebruik

De aansprakelijkheid en garantie van de fabrikant voor schade vervalt bij oneigenlijk gebruik, het niet volgen van deze handleiding, gebruik door niet-gekwalificeerd personeel of ongeoorloofde wijzigingen aan het product.

De fabrikant is niet aansprakelijk voor kosten of schade die ontstaan door de gebruiker of derden als gevolg van het gebruik van dit product, in het bijzonder in gevallen van oneigenlijk gebruik van het product of misbruik of fouten in de aansluiting van het product.

De fabrikant aanvaardt geen aansprakelijkheid voor drukfouten.

1.1.4 Eisen voor veilig gebruik

Let op de volgende punten voor een veilig gebruik van het toestel:

- Indien de apparatuur wordt gebruikt op een wijze die niet door de fabrikant is aangegeven, kan de door de apparatuur geboden bescherming nadelig worden beïnvloed.
- Het product mag alleen worden gebruikt volgens het hierboven aangegeven toegestane gebruik.
- Het product mag alleen van stroom worden voorzien door de energiebronnen die in deze gebruiksaanwijzing worden genoemd.
- Het product mag alleen worden gebruikt onder de omgevingsvoorwaarden die in deze gebruiksaanwijzing worden genoemd.

Het product mag niet geopend of gewijzigd worden.

Het product mag niet gebruikt worden indien:

- het zichtbaar beschadigd is (b.v. na transport)
- het gedurende lange tijd onder ongunstige omstandigheden opgeslagen is geweest (opslagcondities, zie hoofdstuk "Specificaties")

Voorwaarden voor een veilig gebruik van de stekkervoeding

Neem de volgende punten in acht voor een veilig gebruik:

- Controleer voor gebruik op zichtbare beschadigingen. Indien beschadigd, niet in gebruik nemen.
- Alleen in droge ruimten gebruiken.
- Alleen met droge handen vastpakken.
- Alleen de door de fabrikant aanbevolen voeding mag worden gebruikt.
- Het product mag niet worden geopend of gewijzigd.
- Alleen de door de fabrikant aanbevolen USB-C-kabel mag worden gebruikt om het apparaat van stroom te voorzien.

NL

1.1.5 Instructies bewaren

De handleiding moet in de buurt van het product worden bewaard, zodat u de informatie die u nodig hebt, altijd kunt vinden.

1.1.6 Kwalificatie van de gebruiker

Het bedienend personeel moet in staat zijn de veiligheidsetiketten en veiligheidsinstructies op de verpakkingen en inlegvellen van de producten te begrijpen en correct toe te passen.

De gebruiker moet in staat zijn deze handleiding te lezen en te begrijpen om zich vertrouwd te maken met de bediening en een veilig gebruik te waarborgen.

1.1.7 Hantering van gevaarlijke chemicaliën

Waar dit product wordt gebruikt, kunnen chemische en/of biologische gevaren bestaan. Houd u aan alle geldende wetten, voorschriften en protocollen bij het gebruik van dit product.

Bij de ontwikkeling van producten besteedt Lovibond veel aandacht aan veiligheid. Sommige gevaren van gevaarlijke stoffen kunnen niet worden vermeden. Bij gebruik van zelf vervaardigde testen of oplossingen ligt de verantwoordelijkheid voor eventuele risico's veroorzaakt door deze testen of oplossingen bij de gebruiker (eigen verantwoordelijkheid).

Voor uw eigen bescherming wordt bij troebelheidsnormen van meer dan 5 NTU het dragen van beschermende handschoenen of een veiligheidsbril aanbevolen. Neem het relevante veiligheidsinformatieblad in acht.

De veiligheidsinformatiebladen van de chemische stoffen bevatten alle instructies over het veilig hanteren, de optredende gevaren, preventieve maatregelen en de te nemen maatregelen in gevaarlijke situaties.

1.1.8 Instructies voor afvoer

Lever de accu's en de elektrische apparatuur in bij een daarvoor bestemde lokatie in overeenstemming met de plaatselijke wetgeving.

Het is illegaal om batterijen bij het huishoudelijk afval te gooien. Binnen de Europese Unie worden de batterijen aan het einde van de levensduur van het apparaat naar een gespecialiseerd inzamelpunt voor recycling gebracht.



Instrumenten die met dit symbool zijn gemarkeerd, mogen niet bij het normale huisvuil worden weggegooid.

NL

1.2 Lijst van alle in het document gebruikte symbolen

De volgende symbolen worden in deze handleiding gebruikt om aan te geven welke gedeelten speciale aandacht vereisen:



Gevaar!

Er bestaat een gevaar dat de dood of ernstige verwondingen tot gevolg zal hebben als het niet vermeden wordt!



Waarschuwing.

Onjuiste omgang met bepaalde reagentia kan uw gezondheid schaden. Volg in ieder geval de informatie op de veiligheidsetiketten op de verpakking, de veiligheidsinstructies in de bijsluiters en het beschikbare veiligheidsinformatieblad. De daar voorgeschreven beschermingsmaatregelen moeten exact worden opgevolgd.



Let op!

Er bestaat een gevaar dat kan leiden tot licht of middelzwaar letsel.

1.3 Afkortingen

Afkortingen	Definitie
NTU	Nephelometric Turbidity Unit
FNU	Formazin Nephelometric Units
mg/l	Milligram per liter

2 Product overzicht

2.1 Certificering

EMC Geleidende en uitgestraalde emissies	CISPR 11	CE-markering
EMC	EN 61326-1	CE-markering
Veiligheid	EN 61010-1	TÜV-veiligheidskeurmerk
FCC	FCC klasse A	FCC-markering

NL

FCC-kennisgeving klasse A

Dit apparaat voldoet aan deel 15 van de FCC-voorschriften. Het gebruik is onderhevig aan de volgende twee voorwaarden:

- Dit apparaat mag geen schadelijke interferentie veroorzaken.
- Dit apparaat moet alle ontvangen interferentie accepteren, inclusief interferentie die ongewenste werking kan veroorzaken.

Opmerking: Deze apparatuur is getest en in overeenstemming bevonden met de beperkingen voor een digitaal apparaat van klasse A, overeenkomstig deel 15 van de FCC-voorschriften. Deze beperkingen zijn bedoeld om redelijke bescherming te bieden tegen schadelijke interferentie wanneer de apparatuur wordt gebruikt in een commerciële omgeving. Dit apparaat genereert en gebruikt radiofrequentie-energie en kan deze uitstralen. Indien het apparaat niet wordt geïnstalleerd en gebruikt volgens de instructies in de handleiding, kan het schadelijke interferentie veroorzaken in radiocommunicatie. Gebruik van deze apparatuur in een woonwijk zal waarschijnlijk schadelijke interferentie veroorzaken, in welk geval de gebruiker de interferentie op eigen kosten zal moeten corrigeren.

Afgeschermd kabels



Verbindingen tussen het systeem en de randapparatuur moeten worden gemaakt met afgeschermd kabels om te blijven voldoen aan de FCC-limieten voor radiofrequentie-emissie.

Let op!

Modificaties



Wijzigingen aan dit apparaat die niet door Tintometer zijn goedgekeurd, kunnen de door de FCC aan de gebruiker verleende toestemming voor het bedienen van dit apparaat ongeldig maken.

Let op!

NL

DOC klasse A kennisgeving - Avis DOC, klasse A

Dit Klasse A digitale apparaat voldoet aan alle eisen van de Canadese voorschriften voor interferentie veroorzakende apparatuur.

2.2 Kenmerken

Laboratoriumnauwkeurigheid ontmoet draagbaarheid

De Lovibond® TB-serie maakt een einde aan de complexiteit van troebelheidsmetingen. Deze nieuwe technologie biedt het hoogste niveau van nauwkeurigheid en operationele en wettelijke efficiëntie.

- Touchscreen-interface voor bedieningsgemak
- Met afbeeldingen gestuurde instructies om de gebruiker door de processtappen te leiden en fouten te voorkomen.
- Eenvoudige protocollen voor gegevensbeheer om de integriteit van de gegevens te waarborgen

2.3 Beschrijving van het product

Troebelheid is een uitdrukking van de optische eigenschappen van een monster die ervoor zorgt dat lichtstralen worden verstrooid en geabsorbeerd in plaats van in rechte lijnen door een vloeibaar monster te worden doorgelaten. In water wordt troebelheid vaak veroorzaakt door de aanwezigheid van materie zoals klei, slib, fijn verdeelde organische materie, plankton, andere microscopische organismen, organische zuren, en pigmenten. Troebelheidsmetingen worden gebruikt om processen te bewaken waarbij de concentraties van deeltjes in oplossingen worden verwijderd of gewijzigd, zoals bij de productie van drinkwater. Deze Lovibond® turbidimeters zijn ontworpen om de hoge nauwkeurigheid en hoge gevoeligheid die van een laboratoriumturbidimeter worden verwacht, te combineren met draagbaarheid.

2.4 Aanzicht instrument

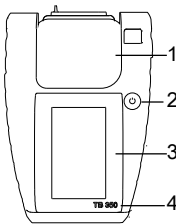
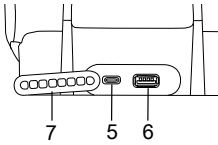
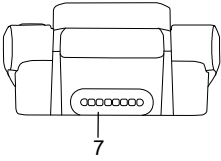
Positie	Omschrijving	Functie
	1. Deksel	Indien geopend kan de gebruiker het testcuvet voor een meting in het apparaat plaatsen.
	2. Aan/uit-toets	Schakelt het apparaat aan en uit.
	3. Touchscreen	Geeft het bedienmenu van het apparaat aan.
	4. Type nummer	Geeft de apparaatversie weer.
	5. USB-C poort	Spanningsverzorging via een externe bron of opladen optioneel accupakket.
	6. USB-A poort	Ondersteunt externe USB-A apparaten voor functies als dataoverdracht of backup.
	7. Afdichting	Dient ter afdekking van de USB aansluitingen als die niet in gebruik zijn.

3 In bedrijf name

3.1 Gebruiksomgeving

Het instrument kan worden gebruikt in elke binnen- of buitenomgeving die veilig wordt geacht voor een operator om de analyse uit te voeren.

Het instrument is geschikt voor waterige monsters van 0 tot 70 °C.

Het instrument moet bij het uitvoeren van een meting $\pm 15^\circ$ waterpas staan.

Het instrument moet op een vlakke ondergrond worden geplaatst om de beste meetprestaties te verkrijgen.

NL

3.2 Inhoud van de levering

Controleer zorgvuldig of alle onderdelen van de onderstaande lijst aanwezig zijn en of er tijdens de verzending geen zichtbare schade is ontstaan. Als er schade is of iets ontbreekt, neem dan onmiddellijk contact op met uw plaatselijke distributeur.

TB	350 IR	350 WL
Instrument	X	X
Siliconenolie, 15 ml	X	X
Microvezeldoek	X	X
2 x meetcuvet	X	X
Schroevendraaier	X	X
Borstel	X	X
Koffer met inzetstuk	X	X
Snelstartgids	X	X
Certificaat van overeenstemming	X	X
Garantieboekje	X	X
4 x AA Batterijen	X	X
Oplaadbaar batterij pack		
USB-C kabel		
AC Stroomvoorziening		
Adapter voor VS, UK en EU Stekkers		
T-CAL® Standard, 5 NTU	X	X
T-CAL® Standard, 20 NTU	X	X
T-CAL® Standard, 800 NTU	X	X
T-CAL® Standard, 2000 NTU		X
T-CAL® Standard, 4000 NTU	X	X

3.3 Plaatsen en vervangen van batterijen

Bij gebruik van batterijen

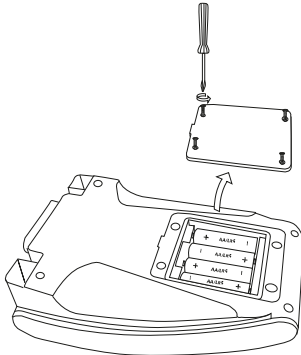

Stap	Beschrijving
1	Gebruik een schroevendraaier om de vier schroeven aan de achterkant van het instrument los te draaien en het paneel te verwijderen.
2	Plaats vier AA-batterijen in de juiste richting.
3	Bevestig het paneel weer op het instrument.



- Gebruik alleen Alkali-Mangaan batterijen, LR6, 1,5V.
- Lege batterijen zo spoedig mogelijk uit het apparaat verwijderen.
- Indien het apparaat langere tijd niet wordt gebruikt verwijder dan de batterijen.

Let op!

Bij gebruik van oplaadbare batterijpack

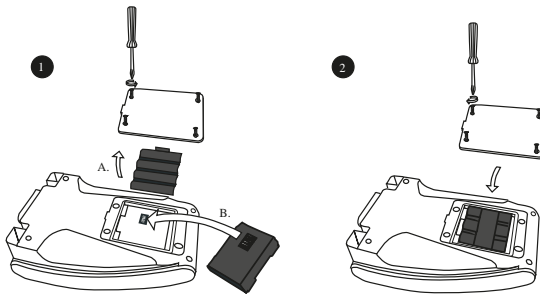

Stap	Beschrijving
1	Gebruik een schroevendraaier om de vier schroeven aan de achterkant van het instrument te verwijderen, verwijder de afdekking en het batterijvak.
2	Plaats de oplaadbare batterijpack in de juiste richting.
3	Bevestig de afdekking weer op het instrument.



Waarschuwing.

De oplaadbare batterijpack (19820-011) is alleen compatibel met instrumenten met serienummer 23041000 en hoger. Het gebruik van het batterijpak voor instrumenten met serienummers voorafgaand aan 23041000 kan leiden tot oververhitting van het apparaat tijdens het opladen. Deze oververhitting kan leiden tot onjuiste meetwaarden en schade aan het apparaat en moet daarom worden vermeden. Neem voor instrumenten met een serienummer lager dan 23041000 contact op met Lovibond® voor meer informatie over het gebruik van dit accessoire.

4 Bediening

4.1 Eerste opstart



1. Welkomsscherm

Beginscherm dat de gebruiker ziet bij de eerste keer inschakelen.
Druk op > toets



2. Selecteer Taal

Selecteer de gewenste taal om in te stellen.
Druk op > toets



3. Datum en tijd instellen

Kies tussen 12- en 24-uurs formaat.
Wijzig waarden met de pijlen omhoog en omlaag.
Druk op > toets



4. Wachtwoord

Stel een door de gebruiker gekozen wachtwoord in om beveiligingsfuncties op het instrument toe te passen.
Druk op de knop Opslaan.
Indien geen wachtwoord gewenst is, selecteer "Overslaan".
Druk op > toets



5. Standaard Eenheden

Selecteer het gewenste eenheidstype om in te stellen.
Druk op > toets



6. Contactgegevens

Voer informatie over de eigenaar van het instrument in.
Druk op de Opslaan-toets.
Indien geen details gewenst zijn, selecteer "Overslaan".
Druk op > toets



7. Overzichtsscherm

Overzicht van initiële instelling.
Druk op < om de instelling te wijzigen voordat u verder gaat.
Druk op > om verder te gaan met het Hoofdscherm.
Gebruiker kan een taak selecteren om met het instrument uit te voeren.

4.2 Algemene werkingsprincipes

De ontwerpen van de TB Series Draagbare Turbidimeters worden opgesplitst in hun respectieve functionele componenten die in detail worden besproken. Deze omvatten de lichtbron, de 90-graden strooilichtval, de strooilichtdetector, de monsterfles van de turbidimeter en hoe deze hoofdcomponenten samenwerken om het troebelingsresultaat te leveren.

De vereenvoudigde optische configuratie voor de TB-serie draagbare turbidimeters.

Deze figuur toont de weg van het invallende licht en het aanzicht van de 90° strooilichtdetector.

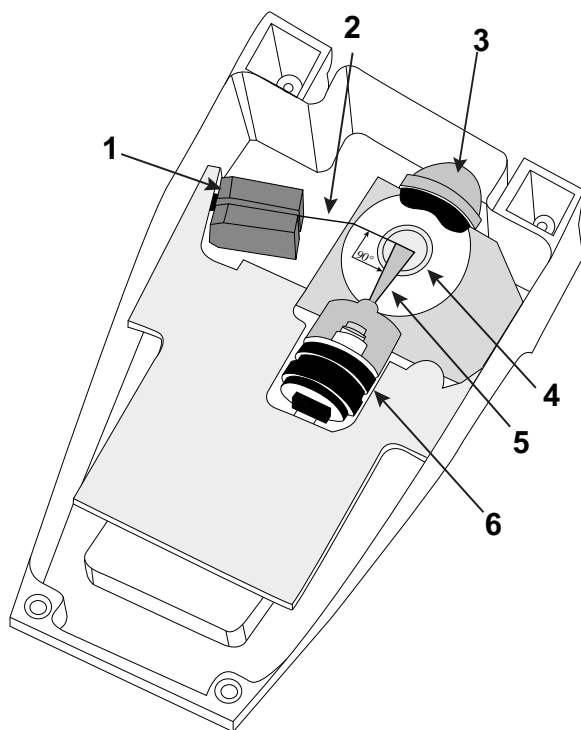





- 1 Belichtingstoestel (LED en Optiek)
- 2 Invallend lichtpad
- 3 90° strooilichtvanger
- 4 Monsterflesje
- 5 Verstrooid licht (10°-20° Detectorzicht)
- 6 Detector van verstrooid licht en optiek



4.3 Lijst van bedieningsorganen en hun functie

4.3.1 Lijst van bedieningsorganen en hun functie









Beschrijving	Functie
1 Statusbalk	Geeft de pictogrammen en labels weer die universeel zijn, waaronder Tijd, Bluetooth®, USB, Beveiliging, Lichtbron & Stroom.
2 Actiegebied	Gebied dat toepassingsstappen en interactie weergeeft.
3 Home-toets	Hoofdzakelijk gebruikt voor navigatie, om acties te starten of op te slaan of af te breken en terug te keren naar Home.













Icoon	Beschrijving
	Meetmodus
	Kalibratiemodus
	Verificatie mode
	Gegevens logboeken

Icoon	Beschrijving
	Bluetooth-verbinding met PTV-procecturbidimeter (niet beschikbaar voor TB 350)
	Instrument instellingen

NL

4.3.2 Lijst van bedieningsorganen en hun functie









Icoon	Beschrijving	Functie
	Naam van de toepassing	Titel van de app die de gebruiker op dat moment gebruikt.
	Tijd	Tijd ingesteld door gebruiker bij eerste instelling of door toegang tot de instrumentinstellingen. 12-uurs of 24-uurs formaat is beschikbaar.
	USB	Indien weergegeven, betekent dit dat er een USB-module op het toestel is aangesloten.
	Bluetooth-symbool - enkele kleur ²⁾	Indien weergegeven, is de Bluetooth®-module aangesloten.
	Bluetooth Pictogram - Met pijlen ²⁾	Indien weergegeven, is de Bluetooth®-module aangesloten en communiceert actief met een PTV of AqualX App.
	Rode Lichtbron - gevuld	Het instrument bevat een rode LED-lichtbron; het licht wordt ingeschakeld voor de meting.
	Rode lichtbron - contouren	Instrument bevat een rode LED lichtbron; er is geen meting actief.
	Witte lichtbron - gevuld	Het instrument bevat een witte LED-lichtbron; het licht wordt ingeschakeld voor de meting.
	Witte lichtbron - contouren	Instrument bevat een witte LED lichtbron; er is geen meting actief.



Icon	Beschrijving	Functie
	Infrarood lichtbron - Aan	Het instrument bevat een infrarode LED-lichtbron; het licht wordt ingeschakeld voor de meting.
	Infrarood lichtbron - Uit	Het instrument bevat een infrarode LED-lichtbron; er is geen meting actief.
	Laser Lichtbron - gevuld ¹⁾	Het instrument bevat een laser-LED-lichtbron; het licht wordt ingeschakeld voor de meting.
	Laserlichtbron - schets ¹⁾	Instrument bevat een laser LED lichtbron; er is geen meting actief.
	AC Batterij Opladen	AC Batterij wordt opgeladen.
	AC Stroom Icoon	Geeft aan dat het instrument wordt gevoed via wisselstroom.
	Batterijvoeding - Groen	Geeft aan dat de batterij nog voor 100% werkt.
	Batterijvoeding - Geel	Geeft aan dat de batterij nog voor 75% mee gaat.
	Batterijvoeding - Oranje	Geeft aan dat de batterij nog voor 50% mee gaat.
	Batterijvoeding - Rood	Geeft aan dat de batterij nog voor 25% mee gaat.
	Meetkamer deksel open	Geeft aan of het deksel van de meetkamer open is.
	Deksel meetkamer gesloten	Geeft aan of het deksel van de meetkamer gesloten is.

¹⁾ alleen TB 600

2) niet TB 350

4.3.3 Statusbalk

Icoon	Beschrijving	Functie
	Home knop	Brengt de gebruiker terug naar het beginscherm.
	Home knop - Gesloten	Beveiliging is actief; wachtwoord is ingeschakeld en vereist om bepaalde functies uit te voeren.
	Home knop - Unlocked	Beveiliging is inactief; geen functies zijn geblokkeerd voor de gebruiker.
	Opslaan Knop	Slaat de inhoud op die in het actieve gebied wordt weergegeven.
	Instellingen knop	Opent het instellingenmenu van een toepassing.
	Uitvoer knop	Exporteert de log(s) die in het actieve gebied worden weergegeven.
	Meting Knop	Start of Begint een meting.
	Meetknop - met Bluetooth ⁽²⁾	Neemt een meting op terwijl aangesloten op een PTV-unit.
	Bluetooth® Vernieuwingsknop ²⁾	Vernieuwt de lijst van beschikbare PTV-eenheden in de nabijheid van het instrument.

Icoon	Beschrijving	Functie
	Annuleer knop	Geeft de optie om de huidige activiteit in het actieve gebied te annuleren.
	Rechts Chevron	Doorgaan naar de volgende stap binnen een proces.
	Links Chevron	Terugkeren naar een vorige stap binnen een proces.

²⁾ niet TB350

NL

4.4 Meting

4.4.1 Weergave van de meetresultaten

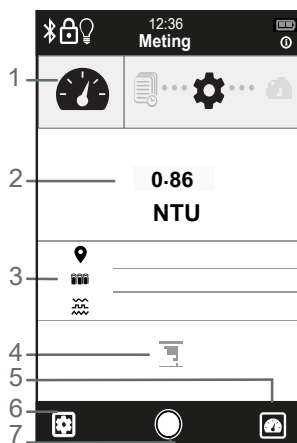

Beschrijving	Functie
1 Toepassingsbalk	Navigatiepad om de gebruiker door de processtappen te helpen.
2 Gemeten waarde	Weergave van het meetresultaat met eenheid.
3 Instellingen	De op de meting toegepaste instellingen worden weergegeven.
4 Log-toets	Creëert een logboek wanneer erop gedrukt wordt.
5 Meet-toets	Start een meting wanneer ingedrukt.
6 Instellingen-toets	Wordt gebruikt om instellingen te wijzigen.

Beschrijving**Functie**

7 Home-toets

Brengt de gebruiker terug naar het beginscherm.

4.4.2 Een meting uitvoeren

Bereid de meetcuvetten die bij de levering inbegrepen zijn voor op de meting. Zorg ervoor dat de meetcuvetten vrij zijn van vlekken, krassen of oneffenheden.

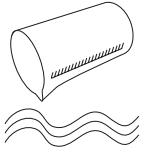
**1. Verzamel het monster**

Zorg ervoor dat het monster representatief is (goed gemengd). Het glaswerk moet vrij zijn van vlekken, krassen of andere oneffenheden.

Spoel de monsternamebeker voor de monstername minimaal 2 keer met het monsterwater.

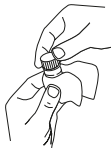
**2. Meetcuvet voorbereiden**

Droog de buitenkant van het meetcuvet met een pluivrije doek. Gebruik siliconenolie om reflecties van strooilicht te minimaliseren.

**3. Plaats meetcuvet in het instrument**

Zorg ervoor dat het monster vrij is van luchtballen.

Langzaam omkeren om te mengen. Niet schudden.

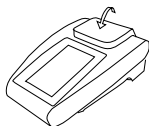
**4. Deksel sluiten**

Metingen zijn niet toegestaan als het deksel niet gesloten is.

**5. Controleer de instellingen**

Controleer of de meetinstellingen juist zijn. Instellingen voor metingen kunnen niet worden gewijzigd nadat de meting is uitgevoerd.

**6. Druk op de Measure knop**

Start de meting.

**7. Gegevens logboeken**

Ga naar "Gegevens logboeken" om de meting op te slaan.

**8. Meting opslaan**

Indien gewenst, druk op de Bewaar knop om een metingslogboek aan te maken.



9. Pauze

Pauzeert de meting in de "continu" meetmodus.



- Breng geen voorwerpen in de meetkamer, behalve de voor de metingen bestemde cuvetten.
- Breng geen vloeistoffen in de kamer.

Waarschuwing!

NL

4.4.3 Tips voor metingen

Indexeren van de spoelbakje: Dit kan het best worden uitgevoerd met een spoelbakje dat gevuld is met water dat door een 0,2 µm filter is gefilterd.

- Druk op de metingstoets.
- Roteer het monster. Terwijl u de spoelbakje roteert, bepaalt u de laagste meting.
- Wanneer de positie is bepaald, stop de meting. Markeer de spoelbakje.
- Voordat u verder gaat met aanvullende metingen, controleert u of de meetmodus is bijgewerkt, indien nodig.
- Het indexeren van het monsterflesje wordt aanbevolen als er een kras of putje in het glaswerk te zien is.

Gebruik van siliconenolie

- Zorg ervoor dat u de spoelbakje alleen bij het bovenste derde deel vastneemt.
- Veeg de spoelbakje af met het bijgeleverde reinigingsdoekje om water, stof en vingerafdrukken te verwijderen.
- Smeer de buitenkant van de libel in met siliconenolie.
 - Breng een zeer dun laagje siliconenolie aan op de zijkant van de libel. Verdeel de kraal olie gelijkmatig over de onderste 2/3 van de libel.
 - Veeg de siliconen uit de spoelbakje door de spoelbakje tegen een schone, stofvrije doek te draaien.
- Het oliën van cellen is kritisch en wordt aanbevolen wanneer monsters worden gemeten met een verwachte troebelheid die lager is dan 0,5 NTU.

Monsters die overtollige luchtballen bevatten

- Laat het monster minimaal vijf minuten staan.
- Keer het monster twee tot drie keer voorzichtig om om de troebelheid te resuspenderen.
- Plaats in het instrument en ga verder volgens de instructies.

Overige opmerkingen

- Het gebruik van ultrasonische baden wordt niet aanbevolen. Ultrasonische energie kan de deeltjesverdeling veranderen.
- Gebruik de Fast Setting Mode voor monsters met hoge concentraties zand of deeltjes met hoge dichtheid.

4.4.4 Meting Instellingen



Druk op de Instellingen knop om naar de Meetinstellingen modus te gaan.

Icoon	Beschrijving	Optie	Functie
	Modus	Single	Druk om een test te starten.
		Continu ¹⁾	De meting wordt elke X seconden bijgewerkt tot ze wordt gestopt.
		Snel uitzakkend	Aanbevolen voor monsters met snelle bezinkingseigenschappen.
	Locatie	Standaard	Wordt gebruikt als geen aangepaste ID is ingesteld.
		Aangepast	Door de gebruiker gedefinieerde beschrijving van de meetplaats en de meetgrenzen.
	Signaal gemiddelden	Op	Indien ingeschakeld, kunnen tot 255 metingen worden ingesteld. De functie moet worden gebruikt als de metingen onstabiel zijn.
		Uit	Gedeactiveerd
	Monster-ID	Standaard	Wordt gebruikt als geen aangepaste ID is ingesteld.
		Aangepast	Unieke identificatiecode van het monster; door de gebruiker te selecteren.

¹⁾ niet TB350

4.5 Kalibratie

4.5.1 Uitlezing van de kalibratie

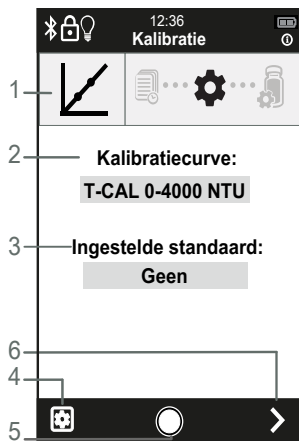

Beschrijving	Functie
1 Toepassingsbalk	Navigatiepad om de gebruiker door de processtappen te helpen.
2 Kalibratiecurve	Specificeert type kalibratie.
3 Ingestelde standaard	Weergave van de te gebruiken standaardset
4 Instellingen-toets	Wordt gebruikt om instellingen te wijzigen.
5 Home-toets	Brengt de gebruiker terug naar het beginscherm.
6 Volgende-toets	Ga naar het volgende scherm.

4.5.2 Een kalibratie uitvoeren

Bereid de bijgeleverde T-CAL® standaarden voor voordat u gaat kalibreren. Zorg ervoor dat de T-CAL® flesjes vrij zijn van vlekken, krassen of verontreiniging.

- T-CAL® standaarden voor TB 350 IR: 20 / 800 / 4000 NTU
- T-CAL® standaarden voor TB 350 WL: 20 / 800 / 2000 / 4000 NTU



- 1. Nulafstelling:**
Voert een nulafstelling uit.

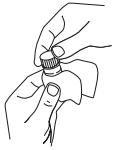

2. Meetcuveet voorbereiden:
Olie het meetcuveet indien nodig.

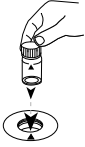

3. Standaard in het apparaat plaatsen:
Plaats de op het display aangegeven standaard.
De gebruiker plaatst een reeks van verschillende troebelheidsstandaarden om de kalibratie te voltooien.



4. Mode:
Geeft actief proces aan.









5. Log Samenvatting:
Druk op de knop Opslaan om het logboek op te slaan.
Druk op de Annuleer-toets om terug te keren naar het begin van het kalibratieproces.

4.5.3 Kalibratie-instellingen



Druk op de knop Settings om de instellingenmodus te openen.

icoon	Beschrijving	Optie	Functie
	Kalibratiecurve	T-CAL [®]	Selecteert geprepareerde gestabiliseerde formazine standaard op voorgedefinieerde concentraties
		Gebruiker Formazine	selecteert door de gebruiker bereide formazine-standaard met vooraf gedefinieerde concentraties
	Ingestelde standaard	Standaard	Wordt gebruikt als geen unieke identificatiecode is ingesteld.
		Uniek	Unieke identicator van de standaardset.
	Herinnering¹⁾	Op	Herinnert gebruiker eraan dat kalibratie nodig is. Optie om kalibratie te forceren voordat bijkomende metingen plaatsvinden.
		Uit	Standaardinstelling.
	Standaard kal		Optie om terug te keren naar de fabriekskalibratie-instelling.

	Naar verificatie	Op	Vereist dat de gebruiker een verificatie uitvoert nadat de kalibratie is voltooid.
		Uit	Standaardinstelling
	Kal checker	Op (Standaard)	Tijdens de kalibratieprocedure, als een individuele standaard buiten de tolerantie valt, moet de gebruiker de standaard corrigeren om verder te gaan of de kalibratieprocedure annuleren. Deze functie voorkomt dat de gebruiker een kalibratiefout maakt als gevolg van een onjuiste standaard. Het logboekscherm heeft een regel voor Kalibratiecontrole en toont een "Aan" of "Ingeschakeld" status.
		Uit	Tijdens de kalibratieprocedure, als een individuele standaard buiten tolerantie is, wordt de gebruiker niet gewaarschuwd dat een kalibrator buiten het voorgedefinieerde bereik van de Tintometer is. Het logboekscherm heeft een regel voor Kalibratiecontrole en toont een "Uit" of "Uitgeschakeld" status.

¹⁾ niet TB350

4.6 Verificatie

4.6.1 Verificatie Overzicht

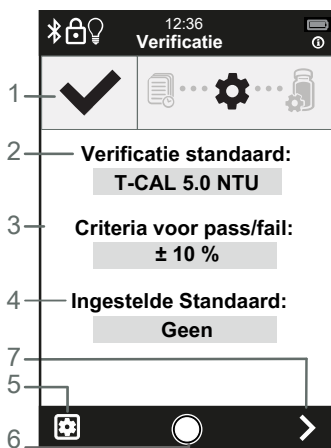

Beschrijving	Functie
1 Toepassingsbalk	Navigatiepad om de gebruiker door de processtappen te helpen.
2 Verificatie norm	Waarde van de te meten standaard.
3 Criteria voor pass/fail	Tolerantie die wordt gebruikt om te bepalen of een verificatie slaagt of mislukt.
4 Ingestelde standaard	Unieke identicator van de standaardset.
5 Instellingen knop	Wordt gebruikt om instellingen te wijzigen.
6 Home knop	Brengt de gebruiker terug naar het beginscherm.
7 Volgende knop	Ga naar het volgende scherm.

4.6.2 Een verificatie uitvoeren

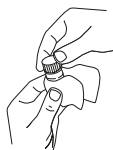

- 1. Spoelbakje voorbereiden:**
Olie het monsterflesje indien nodig.



- 3. Standaard invoegen**
Voegt de standaardwaarde in die op het scherm is gespecificeerd.



- 4. Modaal:**
Vertegenwoordigt actief proces.



- 5. Log Samenvatting**
Druk op de Bewaar knop om het logboek op te slaan.
Druk op Annuleren om terug te keren naar het begin van het verificatieproces.

4.6.3 Verificatie-instellingen



Druk op de knop Settings om de instellingenmodus te openen.

Icoon	Beschrijving	Optie	Functie
	Standaard	T-CAL 5.0 NTU	Selecteert geprepareerde gestabiliseerde formazin-standaard op 5,0 NTU concentratie.
		Gebruiker voorbereid	Selecteert door de gebruiker ingestelde standaard tussen 1 en 1000 NTU.
	Criteria Pass/ Fail	±10%	Tolerantie die wordt gebruikt om te bepalen of een verificatie slaagt of mislukt.
		± 5%	
		±0.05 NTU	
		±0.10 NTU	
	Aangepast		Door gebruiker ingevoerde waarde. Tolerantie van ±20% of ±0,05 - 0,2 NTU toegestaan.
	Herinnering ¹⁾	Op	Herinnert gebruiker eraan dat verificatie nodig is.
		Uit	Standaardinstelling

¹⁾ niet TB350

4.7 Logboeken

4.7.1 Het selecteren van een log type



Druk op de Log Type knop in het Actie Gebied om de Logs te openen.

Toepassingsbalk:



Meetlogboeken:

Geeft alle geregistreerde metingen weer.



Kalibratielogs:

Geeft alle kalibratierecords weer.

**Verificatielogboeken:**

Geeft alle verificatierecords weer.

**Logboeken GLP-modus:**

Geeft het record weer van de GLP-modus die is in- of uitgeschakeld.

¹⁾ niet TB 350

NL

4.7.2 Een logboek ophalen**1. Selecteer type log**

Toont de records van het type log dat de gebruiker wil bekijken.

**2. Individuele logs exporteren**

Als één record wordt geselecteerd, wordt dat logboek geëxporteerd in CSV-formaat.

Alle details van het log worden geëxporteerd.

**3. Selecteer de overdrachtsmethode**

USB: Exporteert het protocol naar een USB-geheugen.

Bluetooth^{®1)}: Exporteert logboek naar mobiele toepassing AquaLX.

Niet beschikbaar op TB 350.

Opmerking: een externe Lovibond[®] Bluetooth[®] dongle is vereist voor aansluiting op de USB-A-poort.¹⁾ niet TB 350**4.8 Instrument Instellingen**

Druk op de Instellingen knop om naar de Instellingen modus te gaan.

Pictogram	Beschrijving	Optie	Functie
	Veiligheid	Inschakelen	Wachtwoord instellen, verifiëren en wijzigen.
		Uitschakelen	Standaard instelling.

**Stroom-
instellingen**

Scherp helderheid	Pas de helderheid van het scherm aan.
Slaapstand achtergrondverl.	Uit 20 seconden 30 seconden 1 minuut* 5 minuten
Systeemafsluiting	Uit 1 minuut 2 minuten 5 minuten 15 minuten* Opmerking: Bij gebruik van de USB-C-voedingskabel staat de systeemuitschakeling op "Uit" totdat het apparaat wordt losgekoppeld en keert dan terug naar de geselecteerde optie.

Bluetooth¹⁾

Inschakelen	Schakelt Bluetooth® in wanneer hardware aanwezig is.
Uitschakelen	Standaard instelling.

**USB-snel-
koppelingen¹⁾**

Inschakelen	Indien ingeschakeld, krijgt de gebruiker, wanneer een USB-opslagapparaat is aangesloten, een modal te zien met een optie voor "logs overbrengen" of "backup/herstel" instellingen. Door een optie te selecteren, wordt de gebruiker naar de juiste functie geleid.
Uitschakelen	Standaardinstelling; gebruikers moeten de instellingen voor "Logs" of "Backup/Restore" openen wanneer een USB-opslagapparaat is aangesloten.



Taal

Selecteer taal.



Datum/Tijd

Selecteer de weergegeven tijd en het formaat.

**Back-up/
Fabriekinst.**Maak een back-up van alle instellingen¹⁾

Optie om instellingen op te slaan op lokale SD-kaart of op externe USB-drive.

Herstel alle instellingen¹⁾

Herstelt eerder opgeslagen instellingen die zijn opgeslagen op een lokale SD-kaart of externe USB-drive.

Herstel naar fabriekinstellingen

Zet alle instellingen terug naar fabriekinstellingen. Opgeslagen logs zijn nog steeds beschikbaar.



Eenheid

NTU

Kies de weergegeven eenheid.

FNU

mg/L Kaolien

mg/L PSL

Graden

mNTU¹⁾mFNU¹⁾Aangepast¹⁾

Bepaalt het eenheidstype van de weergegeven meetwaarde.

NTU is de standaardinstelling.

Door de gebruiker te definiëren eenheidstype en mogelijkheid om een factor in te stellen op basis van NTU/FNU-waarden.

GLP¹⁾

Inschakelen

Vaststelling van een protocol voor gegevensintegriteit voor laboratoria die goede laboratoriumpraktijken volgen.

Uitschakelen

Standaard instelling.

**Eigenaar**

Contactgegevens van de eigenaar van het instrument.

**Contact**

Contactgegevens van Lovibond®-kantoren.

**Over**

Over Lovibond®.

¹⁾ niet TB 350

* Standaard instelling

5 Onderhoud

5.1 Aanbevolen onderhoudsschema

Taak	Doen	Niet doen
1. Reinig de meetkamer 2. Reinig het display	1. Zorg ervoor dat de meetkamer vóór de meting schoon en droog is. Gebruik een droge microvezeldoek om onzuiverheden te verwijderen. 2. Veeg het aanraakscherm af met een droge of licht vochtige microvezeldoek.	1. Een vloeistof rechtstreeks in de meetkamer spuiten of gieten. 2. Een monster meten dat niet goed is afgesloten.
Externe behuizing reinigen	Reinig de buitenste behuizing met een mild reinigingsmiddel of verdunde alcohol.	
Opslag en verzorging van meetcuvetten	Spoel de cuvetten na gebruik altijd met water vrij van troebelheid.	Overvloedig siliconen olie gebruiken die niet van de flacon is geveegd. Een enkel druppeltje is al voldoende.
	Vul de flacon met gedeïoniseerd water. Sluit het cuvet om vorming van watervlekken te voorkomen.	De cuvetten zonder deksel aan de lucht laten drogen.
	Droog de buitenkant van het cuvet met een microvezeldoekje.	Een cuvet gebruiken met zichtbare beschadigingen zoals putjes, krassen of barsten.
Vervanging batterij	Het wordt aanbevolen de batterijen te verwijderen als het apparaat langer dan 30 dagen niet wordt gebruikt, om te voorkomen dat de batterijen gaan lekken.	Het gebruiken van niet gespecificeerde typen batterij.
Kalibratie	Kalibreer indien nodig onder de volgende omstandigheden: <ol style="list-style-type: none"> 1. Verificatiefout. 2. Onderhoud aan optische of elektronische systemen wordt uitgevoerd. 3. Zoals vereist door regionale regelgevende instanties. 	Het gebruiken van verlopen standaarden.
	Volg de instructies voor de bereiding en het gebruik van de standaarden zorgvuldig op.	

Taak	Doen	Niet doen
Verificatie	Controleer de werking van het instrument onder de volgende omstandigheden: <ol style="list-style-type: none"> 1. Na het uitvoeren van een kalibratie. 2. Volgens interne kwaliteitscontroleprocedures. 3. Zoals voorgeschreven door regionale regelgevende instanties. 	Het gebruiken van verlopen standaarden.
	Volg de aanwijzingen voor de bereiding en het gebruik van de standaarden zorgvuldig op.	
Connector afdichting	Zorg ervoor dat de afdichting van de connector is bevestigd wanneer deze zich niet in een laboratoriumomgeving bevindt.	Het toestel opbergen zonder dat deze afdichting is aangebracht. Transport of ondersteuning van het instrument via een verbindingkabel.

Waarschuwing.

Onjuiste omgang met bepaalde reagentia kan uw gezondheid schaden. Volg in ieder geval de informatie op de veiligheidsetiketten op de verpakking, de veiligheidsinstructies in de bijsluiters en het beschikbare veiligheidsinformatieblad. De daar voorgeschreven beschermingsmaatregelen moeten exact worden opgevolgd.

6 Probleemoplossing

6.1 Foutmeldingen en wat te doen

Symptoom	Mogelijke oorzaak	Oplossing
Overrange	De troebelheid van het monster ligt buiten het meetbereik van het instrument.	<ul style="list-style-type: none"> • Verdun het monster • Verifieer de ijking met een standaard met een hoog bereik.
Underrange	De troebelheid van het monster ligt onder de detectiegrens van het instrument.	<ul style="list-style-type: none"> • Herhaal de strooilichtmeting (nulstelling) zoals voorgeschreven en zorg ervoor dat het deksel van het apparaat gesloten is. • Herhaal de kalibratie nadat het strooilicht is bepaald.
Instrument gaat niet aan	De batterijen zijn defect De batterijen zijn niet correct geplaatst	<ul style="list-style-type: none"> • Vervang de batterijen door een compleet nieuwe set.
De knop "Opslaan" voor een functie verschijnt niet, zodat er geen logboek kan worden aangemaakt.	Vereiste informatie ontbreekt.	Zorg ervoor dat de initialen van de gebruiker en alle andere verplichte velden correct zijn ingevuld.
Instrument wil geen meting uitvoeren	Deksel is niet dicht.	Sluit het deksel.
Lage batterij melding	Batterij is onder de 20%.	Batterijen vervangen of opladen.
Instrumentinstellingen zijn niet toegankelijk voor de gebruiker	Het veiligheidsprotocol van het apparaat is actief.	Voer het wachtwoord in om de instellingen en kalibratiefuncties te ontgrendelen.
Kalibratie fout	De meetcuvetten werden vóór de kalibratie niet schoongemaakt.	<ul style="list-style-type: none"> • Spoel de monsterflesjes opnieuw volgens de procedure in de handleiding. Bewaar de flesjes zoals voorgeschreven in de handleiding. • Controleer de vervaldatum van de standaard
Kalibratie fout	De kalibratiestandaarden werden in de verkeerde volgorde gebruikt.	Herhaal de kalibratie met de standaarden van de laagste naar de hoogste waarde.

Symptoom	Mogelijke oorzaak	Oplossing
Kalibratie fout	De kalibratie-standaarden waren niet voldoende gemengd.	Meng de standaarden volgens de instructies onmiddellijk vóór het uitvoeren van de ijking.
Kalibratie fout	Kalibratie-standaarden niet juist bereid waardoor verkeerde troebelheidswaarden.	Herhaal de bereiding van de kalibratiestandaarden, waarbij u ervoor zorgt dat de verdunningen juist zijn.
Verificatie Fout	Verificatie valt buiten de fout marge.	<ul style="list-style-type: none"> • Meng de verificatiestandaard voorafgaand aan de verificatie. • Controleer de goedkeurings- en afkeuringscriteria om er zeker van te zijn dat de criteria niet strenger zijn dan de nauwkeurigheid van de norm en pas deze criteria dienovereenkomstig aan. • Controleer de vervaldatum van de standaard

7 Accessoires en vervangingsonderdelen

7.1 Lijst van accessoires

Omschrijving		Bestelnr.
ASM, 3 Cell Battery Pack, HR6, AA, Ni-MH	TB350 IR, TB350 WL	19820-011
Batterijen (AA), set van 4	TB350 IR, TB350 WL	1950025
Borstel, 11 cm lang	TB350 IR, TB350 WL	380230
Cuvethouder voor 6 ronde cuvetten ø 24 mm	TB350 IR, TB350 WL	418951
Meetcuvetten met zwart deksel, hoogte 55 mm, ø 24 mm, set van 12	TB350 IR, TB350 WL	197655
Reinigingsdoek	TB350 IR, TB350 WL	197635
Set troebelheidsstandaarden T-CAL (5, 20, 800, 2000, 4000 NTU)	TB350 WL	194152
Set troebelheidsstandaarden T-CAL (5, 20, 800, 4000 NTU)	TB350 IR	194154
Siliconenolie	TB350 IR, TB350 WL	194295
T-CAL®-Standard, 4000 NTU, 125 ml	TB350 IR, TB350 WL	48012912
T-CAL®-Standard, 4000 NTU, 500 ml	TB350 IR, TB350 WL	48012950
USB-C cable 1 m, USB-C to A	TB350 IR, TB350 WL	19820-081
Voeding TB series	TB350 IR, TB350 WL	19820-170

7.2 Lijst van accessoires

Beschrijving	Onderdeelnummer
Draagtas	19820-130
Deksel, monsterkamer	19820-095
Deksel, batterijcompartiment	19820-098
Stekker, elastomeer, IP67, I/O	19820-084
Inzetstuk voor 4 AA-batterijen	19820-012

8 Specificaties

Model	Model WM-040-1004 (IR) Model WM-040-1001 (WL)
Lichtbron	Infrarot LED (860 nm) Witte LED
Overeenkomstig norm	ISO 7027 EPA-goedgekeurd (alternatief voor US EPA 180.1)
Meetbeginsel	Nefelometrisch (Multipath 90° BLAC®)
Meetbereik	0,01 - 4000 NTU (FNU)
Resolutie meetwaarde	Autoranging: 0.01-9.99: 0.01 NTU ; 10.0-99.9: 0.1 NTU ; 100-4000: 1 NTU
Nauwkeurigheid	± 1,8 % van aflezing + strooilicht
Reproduceerbaarheid	< 1 % of ± 0,01 NTU
Strooilicht	< 0.014 NTU
Weergegeven eenheid	NTU, FNU, graden, mg/L Kaolien, mg/L PSL
Responstijd	7 seconden
Uitlezingen	Single, Signaal Gem., Fast-Settling
Kalibratie-opties	Kalibratie over het hele bereik van 0 - 4000 NTU
Detector	Silicium Fotodiode
Ratio Mode	Ja
Vereist monstervolume	10 mL (0.4 oz)
Display	Touchscreen in kleur
Weergavegrootte	55 x 95 mm (B x H)
Interfaces	<ul style="list-style-type: none"> • USB-A • USB-C
Datalogger	250 metingen, alle kalibraties, verificaties en herstellen fabrieksinstellingen
Data transfer formaat	.csv
Energiebesparende modus	Ja
Auto – OFF	Door gebruiker instelbaar

Stroomvoorziening	<ul style="list-style-type: none"> • 3 NiMH-battery pack (AA) • 4 batteries (AA) • Universal (90 - 240 VAC), via external power supply
Bedrijfsomstandigheden	<p>Temperatuur: 0 - 50 °C (32 - 122 °F)</p> <p>Vochtigheid: 0 - 90 % bij 30 °C, niet-condenserend</p> <p>Vochtigheid: 0 - 80 % bij 40 °C (104 °F), niet-condenserend</p> <p>Vochtigheid: 0 - 70 % bij 60 °C, niet-condenserend</p>
Beschermingsklasse	IP 67 (Instrument)
	-
Compliance	<ul style="list-style-type: none"> • CE • CSA • FCC A • RoHS • TÜV • UL • WEE
Talen gebruikersmenu	<ul style="list-style-type: none"> • Chinees • Duits • Engels • Frans • Japans • Nederlands • Pools • Portugees • Spaans • Turks
Talen korte gebruiksaanwijzing	<ul style="list-style-type: none"> • Chinees • Duits • Engels • Frans • Italiaans • Nederlands • Portugees • Russisch • Spaans • Turks

Talen gebruiksaanwijzing	<ul style="list-style-type: none"> • Chinees • Duits • Engels • Frans • Italiaans • Nederlands • Portugees • Russisch • Spaans • Turks
Afmetingen	155 x 83 x 225 mm
Gewicht	804 g (898 g with four AA alkaline batteries)
Gewicht met verpakking	(898 g with four AA alkaline batteries)

**Let op!**

Technische wijzigingen voorbehouden!
Om een maximale nauwkeurigheid van de testresultaten te garanderen, moet u altijd de door de fabrikant van het instrument geleverde reagenssystemen gebruiken.

8.1 Specificaties - Netadapter

Type	WR9QA2500USB52NMR6B
Uitvoering	Netadapterstekker, schakelende voeding
Ingangsspanning, frequentie	100 – 240 V \pm 10 %, 50 / 60 Hz \pm 5 %
Ingangsstroom	0.3 A
Primaire adapter	Europa, UK, Australië, USA
Beschermingsklasse	II
Uitgangsspanning, frequentie	5.2 V, DC
Max. uitgangsstroom	2.5 A
Uitgangsbescherming	Uitschakeling en automatische herstart
Bedrijfs omstandigheden	0 °C tot 40 °C, met max. 95 % relatieve luchtvochtigheid
Energie-efficiëntieklasse	VI
Veiligheidsnorm	EN 62368
EMC	EN 55032 FCC Part 15 Klasse A EN 55024
Afmetingen [mm]	31.5 x 41 x 71 (zonder primaire adapter)
Gewicht, met EU adapter	48 g (zonder primaire adapter bladen)

Type	WR9QA2500USB52NMR6B
Goedkeuring, EMC	CE, FCC
Toegestane hoogte meters	5000 m
Vervuilingsniveau	2

**Let op!**

Technische wijzigingen voorbehouden!
Om een maximale nauwkeurigheid van de testresultaten te garanderen, moet u altijd de door de fabrikant van het instrument geleverde reagenssystemen gebruiken.

9 Aanhangsel

9.1 Copyright en handelsmerk kennisgeving

Lovibond®, Tintometer® en T-CAL® zijn geregistreerde handelsmerken van de Tintometer-groep. Alle vertalingen en transliteraties van Lovibond® en Tintometer® worden beschouwd als handelsmerken van de Tintometer®-groep. Het Bluetooth®-merk, het beeldmerk en het combinatiemerk zijn handelsmerken van Bluetooth SIG en elk gebruik door de Tintometer®-groep vindt plaats onder licentie.

İçindekiler

	Sayfa
1 Giriş	286
1.1 Genel bilgi	286
1.1.1 Kullanmadan önce talimatları okuyun	286
1.1.2 Ürünün Amacı	286
1.1.3 Yetkili kullanım	286
1.1.4 Güvenli kullanım için gereklilikler	286
1.1.5 Talimatları saklayın	287
1.1.6 Kullanıcı yeterliliği	287
1.1.7 Tehlikeli kimyasalların kullanımı	287
1.1.8 İmha Etme	287
1.2 Belgede kullanılan tüm karakterlerin listesi	288
1.3 Kısaltmalar	288
2 Ürüne Genel Bakış	289
2.1 Sertifikasyon	289
2.2 Özellikleri	290
2.3 Ürün Açıklaması	290
2.4 Enstrüman görünümü	290
3 Devreye alma	292
3.1 Çalışma ortamı	292
3.2 Teslimat içeriği	292
3.3 Pilleri Takma ve Değiştirme	293
4 Operasyon	295
4.1 İlk devreye alma	295
4.2 Genel çalışma prensipleri	296
4.3 Kontrol elemanlarının listesi ve işlevleri	297
4.3.1 Kontrol elemanlarının listesi ve işlevleri	297
4.3.2 Kontrol elemanlarının listesi ve işlevleri	298
4.3.3 Durum çubuğu	300
4.4 Ölçüm	301
4.4.1 Ölçüme Genel Bakış	301
4.4.2 Ölçüm Yapma	302
4.4.3 Ölçüm İpuçları	303
4.4.4 Ölçüm Ayarları	304
4.5 Kalibrasyon	305
4.5.1 Kalibrasyona Genel Bakış	305
4.5.2 Kalibrasyon Gerçekleştirme	305
4.5.3 Kalibrasyon Ayarları	306

	Sayfa
4.6 Doğrulama	307
4.6.1 Doğrulamaya Genel Bakış	307
4.6.2 Doğrulama Gerçekleştirme	308
4.6.3 Doğrulama Ayarları	309
4.7 Kayıtlar	309
4.7.1 Günlük Türü Seçme	309
4.7.2 Günlük Alma	310
4.8 Enstrüman Ayarları	310
5 Bakım	314
5.1 Yeniden başlatılan bakım programı	314
6 Sorun giderme	316
6.1 Hata mesajları ve yapılması gerekenler	316
7 Aksesuarlar ve Yedek parçalar	318
7.1 Aksesuar Listesi	318
7.2 Aksesuar listesi	318
8 Özellikler	319
8.1 Şartname - Şebeke adaptörü	321
9 Ekler	323
9.1 Telif Hakkı ve Ticari Marka Bildirimi	323

1 Giriş

1.1 Genel bilgi

1.1.1 Kullanmadan önce talimatları okuyun

Bu kılavuz, ürünün güvenli kullanımı hakkında önemli bilgiler sağlar. Lütfen bu kılavuzu dikkatlice okuyun ve kullanmadan önce ürüne alışı.

1.1.2 Ürünün Amacı

TB serisi portatif türbidimetre, cam küvetlerde toplanan ve ardından kapatılan sulu numuneleri analiz etmek için tasarlanmıştır. Küvet, toz ve çiziklerden kaynaklanan parazitleri en aza indirmek için dikkatli bir teknik kullanılarak ölçüme hazırlanır.

Hazırlandıktan sonra küvet ölçüm için cihaza yerleştirilir.

Cihaz laboratuvarında kullanılabilir veya numuneler çekilirken numuneler üzerinde ölçüm yapmak için sahaya götürülebilir.

Bu türbidimetrenin taşınması dikkatli yapılmalıdır. Cihaz sahaya alınırken taşıma çantası kullanılmalıdır. Cihaz devlet uygulamaları için kullanılıyorsa, doğru cihaz modelinin seçildiğinden emin olmak için yerel yetkililerle iletişime geçilmesi tavsiye edilir.

1.1.3 Yetkili kullanım

Hatalı kullanım, bu kılavuza uyulmaması, kalifiye olmayan personel tarafından kullanılması veya üründe yetkisiz değişiklikler yapılması durumunda üreticinin sorumluluğu ve garantisi geçersiz hale gelir.

Üretici firma, bu ürünün kullanımından dolayı, özellikle ürünün yanlış kullanılması veya yanlış kullanım veya ürünün bağlantısındaki hatalarda kullanıcı veya üçüncü şahıslardan kaynaklanan maliyet veya zararlardan sorumlu değildir.

Üretici, baskı hatalarından sorumlu değildir.

1.1.4 Güvenli kullanım için gereklilikler

Cihazın güvenli kullanımı için aşağıdaki noktalara dikkat edin:

- Ekipman, üretici tarafından belirtilmeyen bir şekilde kullanılırsa, ekipmanın sağladığı koruma bozulabilir.
- Ürün yalnızca yukarıda belirtilen izin verilen kullanıma göre kullanılabilir.
- Ürüne yalnızca bu kullanım kılavuzunda belirtilen enerji kaynakları ile güç sağlanabilir.
- Ürün yalnızca bu kullanım kılavuzunda belirtilen çevresel koşullar altında kullanılabilir.
- Ürün açılmamalı veya değiştirilmemelidir.

Ürün şu durumlarda kullanılmamalıdır:

- gözle görülür şekilde hasar görmüş (örneğin, nakledildikten sonra)
- olumsuz koşullar altında uzun süre depolanan (saklama koşulları, bkz. Bölüm "Teknik Özellikler")

Geçmeli güç kaynağı ünitesinin güvenli kullanımı için ön koşullar

Güvenli kullanım için aşağıdaki noktalara dikkat edin:

- Kullanmadan önce görünür hasar olup olmadığını kontrol edin. Hasar görmüşse çalıştırmayın.
- Sadece kuru odalarda kullanın.
- Sadece kuru ellerle tutun.
- Yalnızca üretici tarafından önerilen güç kaynağı kullanılabilir.
- Ürün açılmamalı veya üzerinde değişiklik yapılmamalıdır.
- Cihaza güç sağlamak için yalnızca üretici tarafından önerilen USB-C kablosu kullanılabilir.

1.1.5 Talimatları saklayın

Kılavuz, ihtiyacınız olan bilgileri her zaman bulabilmeniz için ürünün yakınında tutulmalıdır.

1.1.6 Kullanıcı yeterliliği

İşletme personeli, ürünlerin paket ve kesici uçlarındaki güvenlik etiketlerini ve güvenlik talimatlarını anlayabilmeli ve doğru bir şekilde uygulayabilmelidir.

Kullanıcı, kullanıma aşına olmak ve güvenli kullanım sağlamak için bu kılavuzu okuyabilmeli ve anlayabilmelidir.

1.1.7 Tehlikeli kimyasalların kullanımı

Bu ürünün kullandığı yerde kimyasal ve/veya biyolojik tehlikeler olabilir. Bu ürünü kullanırken yürürlükteki tüm yasalara, düzenlemelere ve protokollere uyun.

Ürünlerin geliştirilmesi için Lovibond güvenliğe çok dikkat eder. Tehlikeli maddelerden kaynaklanan bazı tehlikeler önlenmez. Kendi kendine üretilen testler veya solüsyonlar kullanılırsa, bu testlerin veya solüsyonların neden olduğu risklerle ilgili sorumluluk kullanıcıya aittir (kişisel sorumluluk).

Kendi güvenliğiniz için, 5 NTU'dan yüksek bulanıklık standartları için koruyucu eldiven veya gözlük takılmasının tavsiye edildiğini unutmayın. İlgili güvenlik veri sayfasını dikkate alın.

Kimyasalların güvenlik veri formları; güvenli kullanım, meydana gelen tehlikeler, önleyici faaliyetler ve tehlikeli durumlarda yapılması gerekenler hakkında tüm talimatları içerir.

1.1.8 İmha Etme

Pilleri ve elektrikli aletleri yerel yasal düzenlemelere uygun olarak uygun bir tesise atın. Pillerin evsel atıklarla birlikte atılması yasa dışıdır.

Avrupa Birliği içinde, piller cihazın ömrünün sonunda özel bir geri dönüşüm toplama noktasına atılır.



Bu sembolle işaretlenmiş aletler normal evsel atıklarla birlikte atılmamalıdır.

1.2 Belgede kullanılan tüm karakterlerin listesi

Bu kılavuzda, özel dikkat gerektiren bölümleri tanımlamak için aşağıdaki semboller kullanılır:



Tehlike!

Önlenmezse ölüme veya ciddi yaralanmaya yol açan bir tehlike vardır!



Uyarı!

Bazı reaktiflerin yanlış kullanımı sağlığınıza zarar verebilir. Her durumda, ambalaj üzerindeki güvenlik etiketleri, paket broşüründeki güvenlik talimatları ve mevcut güvenlik veri sayfası hakkındaki bilgileri izleyin. Orada ortaya konan koruyucu önlemlere kesinlikle uyulmalıdır.



Dikkat!

Küçük veya orta derecede yaralanmayla sonuçlanabilecek bir tehlike mevcuttur.

1.3 Kısaltmalar

Kısaltmalar	Tanım
NTU	Nephelometric Turbidity Unit
FNU	Formazin Nephelometric Units
mg/l	litre başına miligram

2 Ürüne Genel Bakış

2.1 Sertifikasyon

EMC İletilen ve yayılan emisyonlar	CISPR 11 (A Sınıfı Limitler)	CE işareti
EMC bağışıklık	EN 61326-1 (Endüstriyel sınırlar)	CE işareti
Emniyet	EN 61010-1	TÜV güvenlik işareti
FCC	FCC A sınıfı	FCC işareti

TR

FCC Sınıf A Bildirimi

Bu cihaz, FCC Kurallarının 15. Bölümüne uygundur. Çalıştırma aşağıdaki koşula tabidir:

- Bu cihaz zararlı enterferansa neden olmayabilir.
- Bu cihaz, istenmeyen çalışmaya neden olabilecek parazitler de dahil olmak üzere alınan tüm parazitleri kabul etmelidir.

Not: Bu ekipman test edilmiş ve FCC Kurallarının 15. Bölümü uyarınca A Sınıfı dijital cihaz sınırlarına uygun bulunmuştur. Bu sınırlar, ekipman ticari bir ortamda çalıştırıldığında zararlı parazitlere karşı makul koruma sağlamak üzere tasarlanmıştır. Bu ekipman radyo frekansı enerjisi üretir, kullanır ve yayabilir ve talimat kılavuzuna uygun olarak kurulmaz ve kullanılmazsa, radyo iletişimde zararlı parazite neden olabilir. Bu ekipmanın bir yerleşim bölgesinde çalıştırılması, zararlı enterferansa neden olabilir, bu durumda kullanıcının, masrafları kendisine ait olmak üzere enterferansı düzeltmesi gerekecektir.

Ekranlı Kablolar



FCC radyo frekansı emisyon limitlerine uygunluğu sağlamak için sistem ve çevre birimleri arasındaki bağlantılar blendajlı kablolar kullanılarak yapılmalıdır.

Dikkat!

Değişiklikler



Bu cihazda Tintometer tarafından onaylanmayan herhangi bir değişiklik, FCC tarafından kullanıcıya bu ekipmanı çalıştırması için verilen yetkiyi geçersiz kılabilir.

Dikkat!

DOC Sınıf A Bildirimi - Avis DOC, Sınıf A

Bu A Sınıfı dijital cihaz, Kanada Girişime Neden Olan Ekipman Düzenlemelerinin tüm gereksinimlerini karşılar.

2.2 Özellikleri

Laboratuvar doğruluğu taşınabilirlikle buluşuyor

Lovibond® TB Serisi, bulanıklık ölçümündeki karmaşıklıkları ortadan kaldırır. Bu yeni teknoloji, en yüksek düzeyde doğruluk, operasyonel ve düzenleyici verimlilik sağlar.

- Kullanım kolaylığı için dokunmatik ekran arayüzü
- Kullanıcıyı işlem adımlarında yönlendirmek ve hatalardan kaçınmak için görüntü korumalı talimatlar.
- Veri bütünlüğünü sağlamak için basit veri yönetimi protokolleri

2.3 Ürün Açıklaması

Bulanıklık, bir akışkan numunesi boyunca düz çizgiler halinde iletilmek yerine ışık ışınlarının saçılmasına ve emilmesine neden olan bir numunenin optik özelliklerinin bir ifadesidir. Suda bulanıklığa genellikle kil, silt, ince bölünmüş organik madde, plankton, diğer mikroskobik organizmalar, organik asitler ve pigmentler gibi maddelerin varlığı neden olur. Bulanıklık ölçümü, içme suyu üretimi gibi çözeltilerdeki partikül konsantrasyonlarını ortadan kaldıran veya değiştiren süreçleri izlemek için kullanılır. Bu Lovibond® türbidimetrelere, bir laboratuvar türbidimetresinden beklenen yüksek doğruluk ve yüksek hassasiyeti taşınabilirlikle birleştirmek için tasarlanmıştır.

2.4 Enstrüman görünümü

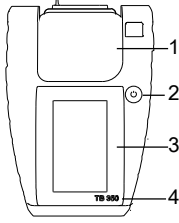
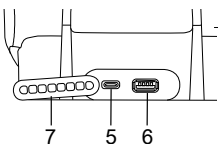
Durum	Açıklama	Fonksiyon
	1. Kapak	Kaldırıldığında, kullanıcının bir okuma için numune hücreini cihaza yerleştirmesine olanak tanır.
	2. Güç düğmesi	Aleti AÇAR ve KAPATIR.
	3. Dokunmatik ekran	Cihazın kullanıcı arayüzünü görüntüler.
	4. Model numarası	Enstrüman sürümünü tanımlar.
	5. USB-C Bağlantı Noktası	Cihaza harici bir kaynaktan güç sağlar veya pil takımı aksesuarını (takılıysa) yeniden şarj eder.
	6. USB-A Bağlantı Noktası	Veri aktarımı veya yedekleme gibi işlevler için harici USB-A cihazını destekler.

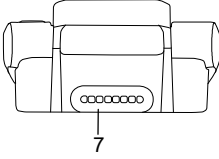
Durum	Açıklama	Fonksiyon
	7. Mühürleme	Bağlantılar kullanılmadığında USB-C ve USB bağlantı noktalarını kapatmak için kullanılır.

TR

3 Devreye alma

3.1 Çalışma ortamı

Cihaz, bir operatörün analizi gerçekleştirmesi için güvenli kabul edilen herhangi bir iç veya dış ortamda kullanılabilir.

Cihaz, 0 ila 70 °C arasında sulu numuneleri kabul edebilir.

Bir ölçüm gerçekleştirirken cihaz, $\pm 15^\circ$ düzeyde olmalıdır.

En iyi ölçüm performansını elde etmek için cihaz düz bir yüzeye yerleştirilmelidir.

TR

3.2 Teslimat içeriği

Aşağıdaki listenin her parçasının mevcut olduğundan ve nakliye sırasında görünür bir hasar oluşmadığından emin olmak için tüm öğeleri dikkatlice inceleyin. Herhangi bir hasar veya eksik bir şey varsa, lütfen hemen yerel distribütörünüzle iletişime geçin.

TB	350 IR	350 WL
Enstrüman	X	X
Silikon Yağı, 15 ml	X	X
Mikrofiber Bez	X	X
2 x Örnek Hücre	X	X
Tornavida	X	X
fırça	X	X
Ekli kılıf	X	X
Hızlı başlangıç Kılavuzu	X	X
Uygunluk belgesi	X	X
Garanti Kitapçığı	X	X
4 x AA Pil	X	X
Şarj Edilebilir Pil Paketi		
USB-C Kablosu		
AC Güç Kaynağı		
ABD, İngiltere ve AB Fişleri için Adaptör		
T-CAL® Standard, 5 NTU	X	X
T-CAL® Standard, 20 NTU	X	X
T-CAL® Standard, 800 NTU	X	X
T-CAL® Standard, 2000 NTU		X
T-CAL® Standard, 4000 NTU	X	X

3.3 Pilleri Takma ve Deęiřtirme

Pilleri kullanırken

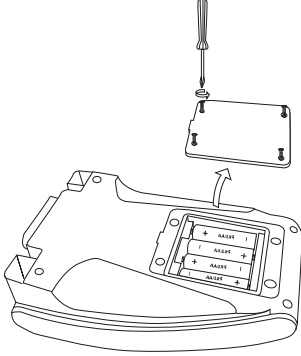

Adım	Tanım
1	Cihazın arkasındaki dört vidayı çıkarmak için bir tornavida kullanın ve paneli çıkarın.
2	Dört adet AA pili doğru yönde yerleştirin.
3	Paneli tekrar cihaza takın.



Dikkat!

- Yalnızca onaylı türü kullanın: 1,5 V voltajlı alkalin manganer pil, LR6.
- Boş pilleri mümkün olan en kısa sürede üniteden çıkarın.
- Ünite uzun süre kullanılmıyacaksa pilleri üniteden çıkarın.

Şarj edilebilir pil takımı kullanırken

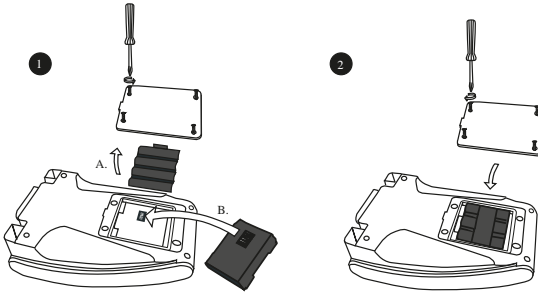

Adım	Tanım
1	Cihazın arkasındaki dört vidayı çıkarmak için bir tornavida kullanın, paneli ve pil tepsisini çıkarın.
2	Şarj edilebilir pil takımını doğru yönde yerleştirin.
3	Paneli tekrar cihaza takın.



Uyarı!

Şarj edilebilir pil takımı (19820-011) yalnızca seri numarası 23041000 ve üzeri olan cihazlarla uyumludur. Pil takımının seri numarası 23041000'dan önce olan cihazlar için kullanılması, şarj sırasında cihazın aşırı ısınmasına neden olabilir. Bu aşırı ısınma, yanlış okumalara ve cihazda hasara yol açabilir ve bu nedenle kaçınılmalıdır. Seri numarası 23041000'den düşük olan cihazlar için, bu aksesuarın kullanımıyla ilgili ayrıntılar için lütfen Lovibond® ile iletişime geçin.

4 Operasyon

4.1 İlk devreye alma



1. Karşılama ekranı

Kullanıcının ilk açılışta gördüğü ilk ekran.
> düğmesine basın



2. Dil Seçim

Ayarlamak istediğiniz dili seçin.
> düğmesine basın



3. Tarih ve Saati Ayarla

12 ve 24 saatlik format arasında seçim yapın.
Yukarı ve aşağı okları kullanarak değerleri değiştirin.
> düğmesine basın



4. Parola

Cihazda güvenlik özelliklerini uygulamak için kullanıcı tarafından seçilen bir parola belirleyin.
Kaydet düğmesine basın.
Parola istenmiyorsa "Atlamak" seçin.
> düğmesine basın



5. Varsayılan Birimler

Ayarlamak için istediğiniz birim türünü seçin.
> düğmesine basın



6. İletişim detayları

Cihaz sahibi bilgilerini girin.
Kaydet düğmesine basın.
Hiçbir ayrıntı istenmiyorsa, "Atlamak" seçin.
> düğmesine basın



7. Özet ekranı

İlk ayarın gözden geçirilmesi.
Devam etmeden önce ayarı değiştirmek için < tuşuna basın.
Ana Ekranı devam etmek için > tuşuna basın.
Kullanıcı, enstrümanla gerçekleştirilecek görevi seçebilir.

4.2 Genel çalışma prensipleri

TB Serisi Taşınabilir Türbidimetrelerin tasarımları, detaylı olarak tartışılan ilgili fonksiyonel bileşenlerine ayrılmıştır. Bunlar arasında ışık kaynağı, 90 derecelik saçılan ışık kapanı, saçılan ışık dedektörü, türbidimetre numune şişesi ve bu önemli bileşenlerin bulanıklık sonucunu sağlamak için birlikte nasıl çalıştığı yer alır.

TR

TB Serisi Taşınabilir Türbidimetreler için basitleştirilmiş optik konfigürasyon.

Bu şekil, gelen ışık yolunu ve 90° saçılan ışık dedektörünün görünümünü göstermektedir.

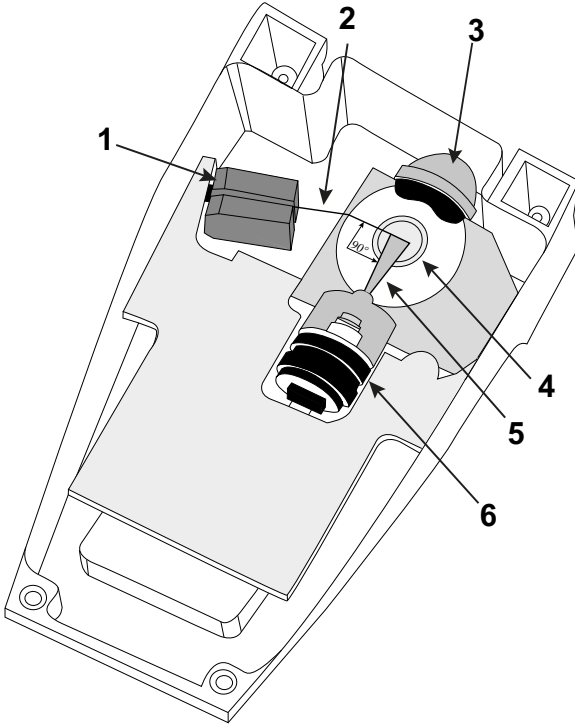





- 1 Aydınlatıcı (LED ve Optik)
- 2 Olay Işık Yolu
- 3 90° Kaçak Işık Tuzağı
- 4 Örnek Şişe
- 5 Dağınık Işık (10°-20° Dedektör Görünümü)
- 6 Dağınık Işık Dedektörü ve Optik

4.3 Kontrol elemanlarının listesi ve işlevleri

4.3.1 Kontrol elemanlarının listesi ve işlevleri



Tanım	İşlev
1 Durum çubuğu	Zaman, Bluetooth®, USB, Güvenlik, Işık Kaynağı ve Güç dahil evrensel olan simgeleri ve etiketleri görüntüler.
2 Eylem Alanı	Uygulama adımlarını ve etkileşimi gösteren alan.
3 Ev Bar	Öncelikle gezinme, eylemleri başlatmak veya kaydetmek veya kapatmak ve Ana Sayfaya dönmek için kullanılır.

Simge	Tanım
	Ölçüm Modu
	Kalibrasyon Modu
	Doğrulama Modu
	Veri Günlükleri

Simge

Tanım









PTV proses türbidimetresine Bluetooth bağlantısı (TB 350 için mevcut değildir)









Enstrüman ayarları

TR

4.3.2 Kontrol elemanlarının listesi ve işlevleri









Simge	Açıklama	İşlev
	Uygulama Adı	Kullanıcının şu anda kullanmakta olduğu uygulamanın başlığı.
12:16	Zaman	Kullanıcı tarafından ilk kurulumda veya cihaz ayarlarına erişilerek ayarlanan süre. 12 saat veya 24 saat formatı mevcuttur.
	USB	Görüntüleniyorsa, üniteye bir USB modülünün takılı olduğunu gösterir.
	Bluetooth Simgesi - Düz ²⁾	Görüntüleniyorsa, Bluetooth® modülü takılıdır.
	Bluetooth Simgesi - Oklarla ²⁾	Görüntüleniyorsa, Bluetooth® modülü takılıdır ve bir PTV veya AquaLX Uygulaması ile aktif olarak iletişim kurar.
	Kırmızı Işık Kaynağı - Dolu	Cihaz, kırmızı bir LED ışık kaynağı içerir; ölçüm için ışık yanar.
	Kırmızı Işık Kaynağı - Anahat	Cihaz, kırmızı bir LED ışık kaynağı içerir; hiçbir ölçüm etkin değil.
	Beyaz Işık Kaynağı - Dolu	Cihaz beyaz bir LED ışık kaynağı içerir; ölçüm için ışık yanar.
	Beyaz Işık Kaynağı - Anahat	Cihaz beyaz bir LED ışık kaynağı içerir; hiçbir ölçüm etkin değil.

Simge	Açıklama	İşlev
	Kızılötesi Işık Kaynağı – Açık	Cihaz bir kızılötesi LED ışık kaynağı içerir; ölçüm için ışık yanar.
	Kızılötesi Işık Kaynağı – Kapalı	Cihaz bir Kızılötesi LED ışık kaynağı içerir; hiçbir ölçüm etkin değil.
	Lazer Işık Kaynağı – Dolu ¹⁾	Cihaz bir lazer LED ışık kaynağı içerir; ölçüm için ışık yanar.
	Lazer Işık Kaynağı – Anahat ¹⁾	Cihaz bir lazer LED ışık kaynağı içerir; hiçbir ölçüm etkin değil.
	AC Pil Şarjı	AC Pil şarj oluyor.
	AC Güç Simgesi	Enstrümana AC gücüyle güç verildiğini gösterir.
	Pil Gücü – Yeşil	Kalan pil ömrünün %100 olduğunu gösterir.
	Pil Gücü – Sarı	Pil ömrünün %75'inin kaldığını gösterir.
	Pil Gücü – Turuncu	Pil ömrünün %50'sinin kaldığını gösterir.
	Pil Gücü - Kırmızı	Pil ömrünün %25'sinin kaldığını gösterir.
	Ölçüm milinin kapağı açık	Ölçüm şaftının kapağının açık olup olmadığını gösterir.
	Ölçüm milinin kapağı kapalı	Ölçüm mili kapağının kapalı olup olmadığını gösterir.

¹⁾ sadece TB 600

2) TB 350 değil

4.3.3 Durum çubuğu

Simge	Açıklama	İşlev
	Ana menü tuşu	Kullanıcıyı ana ekrana döndürür.
	Ana menü tuşu - Kilitli	Güvenlik etkin; parola etkinleştirildi ve belirli işlevleri gerçekleştirmek için gerekli.
	Ana menü tuşu - kilidi açıldı	Güvenlik etkin değil; kullanıcıya hiçbir işlev engellenmez.
	Kaydet Düğmesi	Etkin alanda görüntülenen içeriği kaydeder.
	Ayarlar Düğmesi	Bir uygulamanın ayar menüsünü açar.
	Dışa Aktar Düğmesi	Etkin alanda görüntülenen günlükleri dışa aktarır.
	Ölçüm Düğmesi	Bir ölçümü başlatır veya başlatır veya başlatır.
	Ölçüm Düğmesi – Bluetooth ^{®2)} ile	Bir PTV ünitesine bağlıyken ölçüm yapar.
	Bluetooth [®] Yenileme Düğmesi ²⁾	Enstrümanın yakınındaki mevcut PTV birimlerinin listesini yeniler.

TR

Simge	Açıklama	İşlev
	İptal Düğmesi	Aktif alandaki mevcut aktiviteyi iptal etme seçeneği sunar.
	Sağ şerit	Bir süreç içinde bir sonraki adıma ilerleyin.
	sol şerit	Bir süreç içinde önceki bir adıma dönün.

²⁾ TB350 değil

4.4 Ölçüm

4.4.1 Ölçüme Genel Bakış

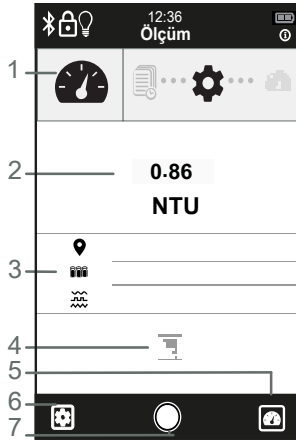

Tanım	İşlev
1 Uygulama Çubuğu	Kullanıcıya işlem adımlarında yardımcı olacak gezinme yolu.
2 Ölçüm değeri	Birim ile ölçüm sonucunun görüntülenmesi.
3 Ayarlar	Ölçüme uygulanan ayarlar görüntülenir.
4 Günlük Düğmesi	Basıldığında bir Günlük oluşturur.
5 Ölçüm Düğmesi	Basıldığında bir ölçüm başlatır.
6 Ayarlar Düğmesi	Ayarları değiştirmek için kullanılır.
7 Ana menü tuşu	Kullanıcıyı ana ekrana döndürür.

4.4.2 Ölçüm Yapma

Lütfen teslimat kapsamındaki numune hücrelerini ölçümden önce hazırlayın. Numune hücrelerinde leke, çizik veya leke olmadığından emin olun.

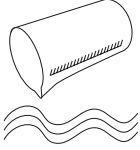

1. Örnek Topla

Numunenin temsili olduğundan emin olun (iyice karıştırılmış). Züccaciye leke, çizik veya diğer kusurlardan arındırılmış olmalıdır.

Numune toplamadan önce toplama kabını numuneyle en az iki kez durulayın.



2. Flakon hazırlayın

Tüy bırakmayan bir bez kullanarak numune şişesinin dışını kurulayın.

Kaçak ışık yansımalarını en aza indirmek için silikon yağı kullanın.

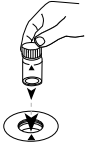

3. Şişeyi alete yerleştirin

Numunenin kabarcıksız olduğundan emin olun.

Karıştırmak için yavaşça ters çevirin. Çalkalama.

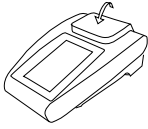

4. Kapağı Kapat

Kapak takılmadan ölçüm yapılmayacaktır.



5. Ayarları Kontrol Et

Ölçüm ayarlarının doğru olduğundan emin olun. Ölçüm yapıldıktan sonra ölçüm ayarları değiştirilemez.



6. Ölçüm Düğmesine Basın

Ölçümü Başlatır.



7. Veri Günlükleri

Ölçümü kaydetmek için Veri Günlüğüne girin.



8. Ölçümü Kaydet

İstenirse, bir ölçüm günlüğü oluşturmak için Kaydet Düğmesine basın.



9. Mola

"Sürekli" ölçüm modunda ölçümü durdurur.



- Ölçümler için tasarlanan küvetler dışında, ölçüm şaftına herhangi bir nesne koymayın.
- Milin içine herhangi bir sıvı koymayın.

Uyarı!

4.4.3 Ölçüm İpuçları

Şişenin indekslenmesi: Bu, en iyi şekilde 0,2 µm'lik bir filtreden filtrelenmiş suyla doldurulmuş bir şişeye gerçekleştirilir.

- Ölçüm düğmesine basın.
- Numuneyi döndürün. Şişeyi döndürürken en düşük değeri belirleyin.
- Konum belirlendiğinde ölçümü durdurun. Şişeyi işaretleyin.
- Ek ölçümlere devam etmeden önce ölçüm modunun gerektiği şekilde güncellendiğinden emin olun.
- Cam eşyada gözle görülür bir çizik veya çukur varsa numune şişesinin indekslenmesi önerilir.

Silikon Yağı Kullanımı

- Şişeyi yalnızca üst üçte birlik kısımdan tutmaya özen gösterin.
- Su, toz ve parmak izlerini temizlemek için flakonu sağlanan temizleme beziyle silin.
- Şişenin dışını silikon yağı ile yağlayın.
 - Şişenin kenarına çok ince bir silikon yağı damlası yerleştirin. Şişenin alt 2/3'üne yağ damlasını eşit şekilde yayın.
 - Şişenin içindeki silikonu temiz, tozsuz bir beze doğru çevirerek silin.
- 0,5 NTU'nun altında beklenen bulanıklığa sahip numuneleri ölçerken yağlama hücreleri kritiktir ve önerilir.

Fazla kabarcık içeren numuneler

- Numunenin en az beş dakika beklemesine izin verin.
- Bulanıklığı yeniden süspansen etmek için numuneyi iki ila üç kez hafifçe ters çevirin.
- Alete yerleştirin ve talimatlara göre ilerleyin.

Diğer notlar

- Ultrasonik banyoların kullanılması tavsiye edilmez. Ultrasonik enerji parçacık dağılımını değiştirebilir.
- Yüksek konsantrasyonda kum veya yüksek yoğunluklu parçacık içeren numuneler için Hızlı Ayar Modunu kullanın.

4.4.4 Ölçüm Ayarları



Ölçüm Ayarları Moduna erişmek için Ayarlar Düğmesine basın.

Simge	Tanım	Option	İşlev
	Mod	Tek	Bir ölçümü başlatmak için basın.
		Sürekli ¹⁾	Ölçüm, durdurulana kadar her X saniyede bir güncellenir.
		Hızlı Yerleşim	Hızlı çökeltme özelliğine sahip numuneler için önerilir.
	Konum	Varsayılan	Özel Kimlik ayarlanmazsa kullanılır.
		Özel	Ölçüm konumu ve ölçüm limitlerinin kullanıcı tanımlı açıklaması.
	Sinyal Ort.	Açma	Açıkça, 255 ölçüme kadar ayarlanabilir. Ölçümler kararsızsa fonksiyon kullanılmalıdır.
		Kapalı	engelli
	Numune Kimliği	Varsayılan	Özel Kimlik ayarlanmazsa kullanılır.
		Özel	Numunenin benzersiz tanımlayıcısı; kullanıcı seçilebilir.

¹⁾ TB350 değil

4.5 Kalibrasyon

4.5.1 Kalibrasyona Genel Bakış

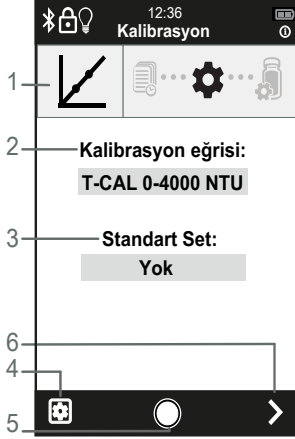

Tanım	İşlev
1 Uygulama Çubuğu	Kullanıcıya işlem adımlarında yardımcı olacak gezinme yolu.
2 Kalibrasyon eğrisi	Kalibrasyon türünü belirtir.
3 Standard Set	Standart setin benzersiz tanımlayıcısı.
4 Ayarlar Düğmesi	Ayarları değiştirmek için kullanılır.
5 Ana menü tuşu	Kullanıcıyı ana ekrana döndürür.
6 Sonraki düğmesi	Sonraki ekrana ilerleme.

4.5.2 Kalibrasyon Gerçekleştirme

Lütfen kalibrasyondan önce teslimat kapsamındaki T-CAL® standartlarını hazırlayın. T-CAL® flakonlarının leke, çizik veya kusur içermediğinden emin olun.

- TB 350 IR için T-CAL® standartları: 20 / 800 / 4000 NTU
- TB 350 WL için T-CAL® standartları: 20 / 800 / 2000 / 4000 NTU

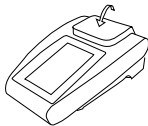

- 1. Sıfır Ayarı:**
Sıfır ayarı yapar.

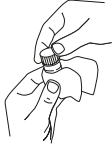

2. Tüpü hazırlayın:
Gerekirse boruyu yağla yağlayın.



3. Standart ekleyin:
Ekranda belirtilen varsayılan değeri ekler.
Kullanıcı, kalibrasyonu tamamlamak için çeşitli bulanıklık standartları dizisini ekleyecektir.



4. Modal:
Aktif süreci temsil eder.





5. Günlük Özeti:
Günlüğü kaydetmek için Kaydet Düğmesine basın.
Kalibrasyon işleminin başlangıcına dönmek için İptal Düğmesine basın.

4.5.3 Kalibrasyon Ayarları



Ayarlar moduna erişmek için Ayarlar Düğmesine basın.

Simge	Tanım	Seçenek	İşlev
	Kal. Eğrisi	T-CAL®	Önceden tanımlanmış konsantrasyonlarda hazırlanmış stabilize formazın standardını seçer
		Kullanıcı Formazın	Önceden tanımlanmış konsantrasyonlarda kullanıcı tarafından hazırlanan formazın standardını seçer
	Standart Set	Varsayılan	Benzersiz tanımlayıcı ayarlanmadıysa kullanılır.
		Benzersiz	Standart setin benzersiz tanımlayıcısı.
	Hatırlatma ¹⁾	açma	Kullanıcıya kalibrasyonun zamanının geldiğini hatırlatır. Ek ölçümler gerçekleşmeden önce Kalibrasyona zorlama seçeneği.
		kapalı	varsayılan ayarlar
	Varsayılan Kal		Fabrika kalibrasyon ayarına dönme seçeneği.

	Kayıt Doğrulama	açma	Kalibrasyon tamamlandıktan sonra kullanıcının bir Doğrulama yapmasını gerektirir.
		kapalı	varsayılan ayarlar
	Cal denetleyicisi	açma (Varsayılan)	Kalibrasyon prosedürü sırasında, tek bir standart tolerans dışındaysa, kullanıcı kalibrasyon prosedürüne devam etmek veya iptal etmek için standardı düzeltmelidir. Bu özellik, kullanıcının yanlış bir standart nedeniyle kalibrasyon hatası yapmasını engeller. Günlük ekranında Kalibrasyon Denetleyicisi için bir satır ögesi olacak ve "Açık" veya "Etkin" durumu gösterecek.
		kapalı	Kalibrasyon prosedürü sırasında, bireysel bir standart tolerans dışındaysa, kullanıcıya bir kalibratörün Tintometers tarafından önceden tanımlanmış aralığın dışında olduğu bildirilmez. Günlük ekranında Kalibrasyon Denetleyicisi için bir satır ögesi olacak ve "Kapalı" veya "Devre Dışı" durumu gösterecek.

¹⁾ TB350 değil

4.6 Doğrulama

4.6.1 Doğrulamaya Genel Bakış

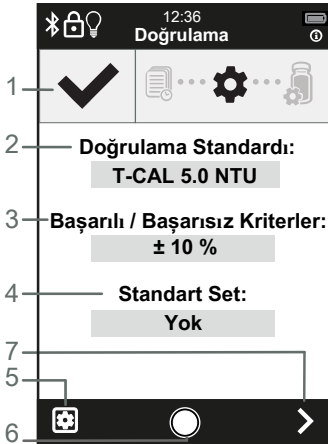

Tanım	İşlev
1 Uygulama Çubuğu	Kullanıcıya işlem adımlarında yardımcı olacak gezinme yolu.
2 Doğrulama standardı	Ölçülecek Standardın Değeri.
3 Başarılı/Başarısız Kriterler	Bir doğrulamanın geçip geçmediğini belirlemek için kullanılan tolerans.
4 Standart Set	Standart setin benzersiz tanımlayıcısı.
5 Ayarlar Düğmesi	Ayarları değiştirmek için kullanılır.
6 Ana menü tuşu	Kullanıcıyı ana ekrana döndürür.
7 Sonraki düğmesi	Sonraki ekrana ilerleme.

4.6.2 Doğrulama Gerçekleştirme



1. Flakon hazırlayın

Gerekirse yağ numunesi şişesi.

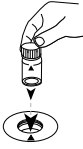

3. Standart Ekle

Ekranda belirtilen standart değeri girin.



4.Modal:

Aktif süreci temsil eder.



5. Günlük Özeti



Günlüğü kaydetmek için Kaydet düğmesine basın.

Doğrulama işleminin başına dönmek için İptal Düğmesine basın.

4.6.3 Doğrulama Ayarları



Ayarlar moduna erişmek için Ayarlar Düğmesine basın.

Simge	Tanım	Seçenek	İşlev
	Standart	T-CAL 5.0 NTU	5.0 NTU konsantrasyonunda hazırlanmış stabilize formazin standardını seçer.
		Kullanıcının Hazırladığı	1 ile 1000 NTU arasında kullanıcı tarafından hazırlanmış standardı seçer.
	Pass/ Fail kriterleri	±10%	Bir doğrulamanın geçip geçmediğini belirlemek için kullanılan tolerans.
		± 5%	
		±0.05 NTU	
		±0.10 NTU	
		Özel	Kullanıcı tarafından girilen değer. ±%20 veya ±0,05 – 0,2 NTU toleransına izin verilir.
	Hatırlatma¹⁾	açma	Kullanıcıya doğrulamanın zamanının geldiğini hatırlatır.
		kapama	varsayılan ayarlar

¹⁾ TB350 değil

4.7 Kayıtlar

4.7.1 Günlük Türü Seçme



Günlüklere erişmek için Eylem Alanındaki Günlük Türü Düğmesine basın.

Uygulama çubuğu:



Ölçüm Kayıtları:

Kaydedilen tüm ölçümleri görüntüler.



Kalibrasyon Günlükleri:

Tüm kalibrasyon kayıtlarını görüntüler.



Doğrulama Kayıtları:

Tüm doğrulama kayıtlarını görüntüler.

¹⁾

ILU Modu Günlükleri:

Etkinleştirilen veya devre dışı bırakılan ILU modunun kaydını görüntüler.

¹⁾ TB 350 değil

TR

4.7.2 Günlük Alma



1. Günlük türünü seçin

Kullanıcının görüntülemek istediği günlük türünün kayıtlarını görüntüler.



2. Bireysel Günlükleri Dışa Aktarın

Tek bir kayıt seçilirse, o günlük CSV formatında dışa aktarılır. Günlükle ilgili tüm ayrıntılar dışa aktarılır.



3. Aktarım yöntemini seçin

USB: Günlüğü bir USB depolama aygıtına aktarır.



Bluetooth^{®1)}: Günlüğü AqualX mobil uygulamasına aktarır. TB 350'de mevcut değildir.

Not: USB-A bağlantı noktasına bağlantı için harici bir Lovibond[®] Bluetooth[®] dongle gereklidir.

¹⁾ TB 350 değil

4.8 Enstrüman Ayarları



Ayarlar Moduna erişmek için Ayarlar Düğmesine basın.

Simge	Tanım	Seçenek	İşlev
	Güvenlik	Etkinleştirme	Parolayı ayarlayın, doğrulayın ve değiştirin.
		devre dışı bırakmak	Varsayılan ayarlar.

**Güç ayarları**

Ekran parlaklığı

Ekranın parlaklığını ayarlayın.

Arka ışığı kapat

kapalı
20 saniye
30 saniye
1 dakika*
5 dakika

Sistem kapatma

kapalı
1 dakika
2 dakika
5 dakika
15 dakika*

Not: USB-C güç kablosunu kullanırken, cihaz fişten çekilene kadar sistem kapatma kapalı olarak ayarlanacak ve ardından seçilen seçeneğe geri dönecektir.

**Bluetooth¹⁾**

Etkinleştirme

Donanım mevcut olduğunda Bluetooth®'u etkinleştirir.

devre dışı bırakmak

Varsayılan ayarlar.

**USB Kısayolları¹⁾**

Etkinleştirme

Etkinleştirilirse, bir USB depolama aygıtı bağlandığında, kullanıcıya "günlükleri aktarma" veya "yedekleme/geri yükleme" ayarları için bir seçenek sunan bir modal sunulur. Bir seçenek seçilerek kullanıcı uygun fonksiyona yönlendirilir.

devre dışı bırakmak

Varsayılan ayarlar; kullanıcılar, USB depolama aygıtı bağlandığında "Günlükler" veya "Yedekle/Geri Yükle" ayarlarına erişmelidir.

**Dil**

Dil Seçin.



Tarih / Saat

Görüntülenen zamanı seçin ve biçimlendirin.



Yedekleme / Geri Yükleme

Tüm Ayarları Yedekle¹⁾

Ayarları yerel SD Karta saklama veya harici USB sürücüye kaydetme seçeneği.

Tüm Ayarları Geri Yükle¹⁾

Yerel SD karta veya harici USB sürücüsüne kaydedilen önceden saklanan ayarları kurtarır.

Fabrika Ayarlarını Geri Yükle

Tüm ayarları fabrika varsayılanlarına sıfırlar. Kaydedilen günlükler hala kullanılabilir.



Birim Tipi

NTU

Görüntülenen birimi seçin.

FNU

Görüntülenen ölçüm değerinin birim tipini tanımlar.

mg/L Kaolin

NTU Varsayılan ayardır.

mg/L PSL

derece

mNTU¹⁾mFNU¹⁾Özel¹⁾

Kullanıcı tanımlı birim tipine ve NTU/FNU değerlerine dayalı bir faktör ayarlama yeteneğine izin verin.

GLP¹⁾

Etkinleştirmek

İyi Laboratuvar Uygulamalarını takip eden laboratuvarlar için veri bütünlüğü protokolü oluşturur.

devre dışı bırakmak

Varsayılan ayarlar.

**Sahibi**

Enstrüman sahibinin iletişim bilgileri.

**Bize Ulaşın**

Lovibond® ofisleri için iletişim bilgileri.

**Hakkında**

Lovibond® hakkında.

¹⁾ TB 350 değil

* Varsayılan ayarlar

TR

5 Bakım

5.1 Yeniden başlatılan bakım programı

Görev	Yapmak	Yapma
1. Temiz ölçüm odası	1. Ölçümden önce ölçüm odasının temiz ve kuru olduğundan emin olun. Kirleri temizlemek için kuru bir mikrofiber bez kullanın.	1. Herhangi bir sıvıyı doğrudan ölçüm odasına püskürtün veya dökün.
2. Temiz gösterge ekranı	2. Dokunmatik ekranı kuru veya hafif nemli bir mikrofiber bezle silin.	2. Sıkıca kapatılmamış bir numuneyi ölçün.
Temiz dış muhafaza	Dış muhafazayı hafif bir deterjan solüsyonu veya seyreltilmiş alkol ile temizleyin.	
Numune Hücre Saklama ve Bakımı	Kullanımdan sonra şişeleri daima bulanık olmayan su ile durulayın.	Şişeden silinmemiş aşırı silikon yağı kullanın. Tek bir boncuk gerekli.
	Şişeyi deiyonize su ile doldurun. Su lekelerinin oluşmasını önlemek için şişeyi kapatın.	Numune hücrelerini açık havada kurumaya bırakın.
	Mikrofiber bir bezle flakonun dışını silerek kurulayın.	Çukurlar, çizikler veya çatlaklar dahil görünür kusurları olan herhangi bir şişeyi kullanın.
Pil Değişirme	Pil sızıntısını önlemek için cihaz 30 günden fazla saklanırsa pillerin çıkarılması önerilir.	Belirtilmemiş tipte pil kullanın.
Kalibrasyon	Aşağıdaki koşullarda gerektiği gibi kalibre edin: 1. Doğrulama hatası. 2. Optik veya elektronik sistemlerin bakımı yapılır. 3. Bölgesel düzenleyici makamların gerektirdiği şekilde.	Süresi dolmuş standartları kullanın.
	Standartların hazırlanması ve kullanılması talimatlarını dikkatlice izleyin.	

Görev	Yapmak	Yapma
Doğrulama	<p>Cihaz performansını aşağıdaki koşullar altında doğrulayın:</p> <ol style="list-style-type: none"> 1. Kalibrasyon yaptıktan sonra. 2. Dahili kalite kontrol prosedürlerine göre. 3. Bölgesel düzenleyici makamların gerektirdiği şekilde. 	Süresi dolmuş standartları kullanın.
	Standartların hazırlanması ve kullanımı için talimatları dikkatlice izleyin.	
Fiş / mühür	Laboratuvar ortamında olmadığı zamanlarda port contasının yerinde olduğundan emin olunuz.	<p>Mühür takılı olmadan cihazı saklamayın.</p> <p>Enstrümanı bir konektör kablosuyla taşıyın veya destekleyin.</p>



Uyarı!

Bazı reaktiflerin yanlış kullanımı sağlığınıza zarar verebilir. Her durumda, ambalaj üzerindeki güvenlik etiketleri, paket broşüründeki güvenlik talimatları ve mevcut güvenlik veri sayfası hakkındaki bilgileri izleyin. Orada ortaya konan koruyucu önlemlere kesinlikle uyulmalıdır.

6 Sorun giderme

6.1 Hata mesajları ve yapılması gerekenler

Belirti	Muhtemel neden	Çözüm
Aralığında	Numunenin bulanıklığı, cihazın ölçüm aralığının dışında.	<ul style="list-style-type: none"> Numuneyi seyreltin Yüksek aralıklı bir standart kullanarak kalibrasyonu doğrulayın.
Aralığın altında	Numunenin bulanıklığı, cihazın tespit limitinin altındadır.	<ul style="list-style-type: none"> Dağınık ışık ölçümünü (sıfır ayarı) belirttiği şekilde tekrarlayın ve numune kapağının kapalı olduğundan emin olun. Kaçak ışık belirlendikten sonra kalibrasyonu tekrarlayın.
Enstrüman açılmıyor	Piller arızalı Piller doğru takılmamış	<ul style="list-style-type: none"> Pilleri tamamen yeni bir setle değiştirin.
Bir işlev için "Kaydet" düğmesi görünmez, bu nedenle günlük oluşturulamaz.	Gerekli bilgiler eksik.	Kullanıcı adının baş harflerinin ve diğer tüm gerekli alanların doğru şekilde adreslendiğinden emin olun.
Cihaz ölçüm almayacak	Lid is not closed	Kapağı kapat.
Düşük pil bildirimi	Pil %20'nin altında.	Pilleri değiştirin veya yeniden şarj edin.
Enstrüman ayarlarına kullanıcı tarafından erişilemiyor	Cihaz güvenlik protokolü etkin.	Ayarlar ve Kalibrasyon işlevlerinin kilidini açmak için şifreyi girin.
Kalibrasyon Hatası	Numune şişeleri kalibrasyondan önce temizlenmedi.	<ul style="list-style-type: none"> Kılavuzdaki prosedürü kullanarak numune şişelerini tekrar yıkayın. Şişeleri kılavuzda belirttiği şekilde saklayın. Standartın son kullanma tarihini kontrol edin
Kalibrasyon Hatası	Kalibrasyon standartları yanlış sırada çalıştırıldı.	En düşük değerden en yüksek değere doğru çalışan standartlarla kalibrasyonu tekrarlayın.

Belirti	Muhtemel neden	Çözüm
Kalibrasyon Hatası	Kalibrasyon standartları yeterince karıştırılmamış.	Kalibrasyonu gerçekleştirmeden hemen önce standartları belirtildiği şekilde karıştırın.
Kalibrasyon Hatası	Kalibrasyon Standartları yanlış bulanıklık değerlerine göre hazırlanmıştır.	Seyreilmelerin doğru olduğundan emin olarak kalibrasyon standartlarının hazırlanmasını tekrarlayın.
Doğrulama hatası	Doğrulama, Hata sınırlarının dışında kalıyor.	<ul style="list-style-type: none"> • Doğrulama önceden önce doğrulama standardını karıştırın. • Kriterlerin standardın doğruluğundan daha sıkı olmadığından emin olmak için geçti/kaldı kriterlerini kontrol edin ve bu kriterleri buna göre ayarlayın. • Standardın son kullanma tarihini kontrol edin

7 Aksesuarlar ve Yedek parçalar

7.1 Aksesuar Listesi

Başlık	Ürün No
6 yuvarlak küvet için küvet Ø 24 mm	TB350 IR, TB350 WL 418951
12 adet siyah kapaklı numune küveti Yükseklik 55 mm Ø 24 mm	TB350 IR, TB350 WL 197655
ASM, 3-элементный аккумуляторный блок, HR6, AA, Ni-MH	TB350 IR, TB350 WL 19820-011
Bulanıklık standartları seti T-CAL (5, 20, 800, 2000, 4000 NTU)	TB350 WL 194152
Bulanıklık standartları seti T-CAL (5, 20, 800, 4000 NTU)	TB350 IR 194154
Fırça, uzunluk 11 cm	TB350 IR, TB350 WL 380230
Pil (AA), 4'lü set	TB350 IR, TB350 WL 1950025
Silikon Yağ	TB350 IR, TB350 WL 194295
TB series güç kaynağı	TB350 IR, TB350 WL 19820-170
T-CAL®-Standard, 4000 NTU, 125 ml	TB350 IR, TB350 WL 48012912
T-CAL®-Standard, 4000 NTU, 500 ml	TB350 IR, TB350 WL 48012950
Temizleme Bezi	TB350 IR, TB350 WL 197635
USB-C kablosu 1 m, USB-C - A	TB350 IR, TB350 WL 19820-081

7.2 Aksesuar listesi

Açıklama	Parça Numarası
Taşıma çantası	19820-130
Kapak, numune odası	19820-095
Kapak, Pil bölmesi	19820-098
Fiş, Elastomerik, IP67, I/O	19820-084
4 adet AA pil için yerleştirme	19820-012

8 Özellikler

Model	Model WM-040-1004 (IR) Model WM-040-1001 (WL)
Işık Kaynağı	Kızılötesi LED (860 nm) Beyaz LED
Mevzuata uygunluk	ISO 7027 EPA onaylı (US EPA 180.1'e alternatif)
Ölçüm Prensibi	Nefelometrik (Multipath 90° BLAC)
Ölçüm Aralığı	0.01 - 4000 NTU (FNU)
Kararlılık	Otomatik değişen: 0.01-9.99: 0.01 NTU ; 10.0-99.9: 0.1 NTU ; 100-4000: 1 NTU
Doğruluk	± 1.8 % okuma + sokak lambası
Tekrarlanabilirlik	%1 veya ± 0.01 NTU'dan daha iyi
Sapan Işık	< 0.014 NTU
Görüntülenen birim	NTU, FNU, derece, mg/L Kaolin, mg/L PSL
Tepki Süresi	7 saniye
Okuma Modları	Tek, Sinyal Ort., Fast-Settling
Kalibrasyon Seçenekleri	0 - 4000 NTU arasında tam aralıklı kalibrasyon
Dedektör	Silikon Fotodiyot
Ratio Modu	Evet
Gerekli numune hacmi	10 mL (0.4 oz)
Ekran	Tam Renkli Dokunmatik Ekran
Ekran Boyutu	55 x 95 mm (G x Y)
Arayüzler	• USB-A • USB-C
Veri Kaydedici	250 ölçüm, tüm kalibrasyonlar, doğrulamalar ve fabrika geri yükleme işlemleri
Veri Aktarım Formatı	.csv
Güç tasarrufu modu	Evet
Auto – OFF	Seçilebilir

Güç Kaynağı	<ul style="list-style-type: none"> • 3 NiMH-battery pack (AA) • 4 batteries (AA) • Universal (90 - 240 VAC), via external power supply
Çevre Koşulları	<p>Sıcaklık: 0 - 50 °C (32 - 122 °F)</p> <p>Nem: 30 °C'de %0 - 90, yoğunlaşmaz</p> <p>Nem: 40 °C'de %0 - 80, yoğunlaşmaz</p> <p>Nem: 60 °C'de %0 - 70, yoğunlaşmaz</p>
Koruma Sınıfı	IP 67 (Cihaz)
Uygunluk	<ul style="list-style-type: none"> • CE • CSA • FCC A • RoHS • TÜV • UL • WEE
Diller Kullanıcı Arabirimi	<ul style="list-style-type: none"> • Almanca • Çince • Flemenkçe • Fransızca • İngilizce • İspanyolca • Japonca • Polonyaca • Portekizce • Türkçe
Diller Hızlı Başlangıç Kılavuzu	<ul style="list-style-type: none"> • Almanca • Çince • Flemenkçe • Fransızca • İngilizce • İspanyolca • İtalyanca • Portekizce • Rusça • Türkçe

Diller Tam Kullanım Kılavuzu	<ul style="list-style-type: none"> • Almanca • Çince • Flemenkçe • Fransızca • İngilizce • İspanyolca • İtalyanca • Portekizce • Rusça • Türkçe
Boyutlar	155 x 83 x 225 mm
Ağırlık	804 g (898 g with four AA alkaline batteries)
Ambalajlı Ağırlık	(898 g with four AA alkaline batteries)



Dikkat!

Teknik değişikliğe tabidir!

Test sonuçlarının maksimum doğruluğunu sağlamak için daima cihaz üreticisi tarafından sağlanan reaktif sistemlerini kullanın.

8.1 Şartname - Şebeke adaptörü

Tip	WR9QA2500USB52NMR6B
Tasarım	Şebeke adaptör fişi, anahtarlama güç kaynağı
Giriş voltajı, frekans	100 – 240 V \pm 10 %, 50 / 60 Hz \pm 5 %
giriş akımı	0.3 A
Birincil adaptör	Avrupa, İngiltere, Avustralya, ABD
Koruma sınıfı	II
Çıkış voltajı, frekans	5.2 V, DC
Maks. çıkış akımı	2.5 A
Çıkış koruması	Çıkış kapatma ve otomatik yeniden başlatma
Çevre koşulları	0 °C ila 40 °C, maks. % 95 bağıl hava nemi
Enerji verimliliği sınıfı	VI
Güvenlik standardı	EN 62368
EMC	EN 55032 FCC Part 15 Sınıf A EN 55024
Boyutlar [mm]	31.5 x 41 x 71 (birincil adaptör olmadan)
Ağırlık, EU adaptörüyle	48 g (birincil adaptör bıçakları olmadan)

Tip	WR9QA2500USB52NMR6B
Onay, EMC	CE, FCC
İzin verilen yükseklik ölçerler	5000 m
Kirlilik seviyesi	2

**Dikkat!**

Teknik deęişikliğe tabidir!
Test sonuçlarının maksimum doğruluęunu saęlamak için daima cihaz üreticisi tarafından saęlanan reaktif sistemlerini kullanın.

TR

9 Ekler

9.1 Telif Hakkı ve Ticari Marka Bildirimi

Lovibond®, Tintometer® ve T-CAL®, Tintometer şirketler grubunun tescilli ticari markalarıdır. Lovibond® ve Tintometer®'in tüm çevirileri ve transliterasyonları, The Tintometer® Group'un ticari markaları olarak kabul edilir. Bluetooth® işareti, şekil işareti ve kombinasyon işareti, Bluetooth SIG'ye ait ticari markalardır ve Tintometer® Group tarafından her türlü kullanım lisansa tabidir.

Оглавление

	Сторона
1 Введение	326
1.1 Общая информация	326
1.1.1 Прочтите инструкцию перед использованием	326
1.1.2 Назначение продукта	326
1.1.3 Разрешенное использование	326
1.1.4 Требования к безопасному использованию	326
1.1.5 Соблюдайте инструкции	327
1.1.6 Квалификация пользователя	327
1.1.7 Обращение с опасными химическими веществами	327
1.1.8 Инструкции по утилизации	328
1.2 Список всех символов, используемых в документе	328
1.3 Сокращения	328
2 Обзор продукции	329
2.1 Сертификация	329
2.2 Характеристики	330
2.3 Описание продукта	330
2.4 Вид на прибор	331
3 Ввод в эксплуатацию	332
3.1 Условия эксплуатации	332
3.2 Содержание поставки	332
3.3 Установка и замена батареек	333
4 Операция	335
4.1 Первый запуск	335
4.2 Общие принципы работы	336
4.3 Список элементов управления и их функции	337
4.3.1 Список элементов управления и их функции	337
4.3.2 Список элементов управления и их функции	338
4.3.3 Строка состояния	340
4.4 Измерение	341
4.4.1 Обзор измерений	341
4.4.2 Выполнение измерения	342
4.4.3 Советы по измерению	343
4.4.4 Настройки измерений	344
4.5 Описание отдельных этапов работы или отдельных разделов пользовательского интерфейса	345
4.5.1 Обзор калибровки	345
4.5.2 Выполнение калибровки	345
4.5.3 Настройки калибровки	346

	Страница
4.6 Верификация	348
4.6.1 Обзор верификации	348
4.6.2 Выполнение верификации	348
4.6.3 Настройки верификации	349
4.7 Журналы	350
4.7.1 Выбор типа журнала	350
4.7.2 Извлечение журнала	350
4.8 Настройки прибора	351
5 Техническое обслуживание	355
5.1 Повторный график технического обслуживания	355
6 Устранение неполадок	357
6.1 Сообщения об ошибках и что делать	357
7 Аксессуары и запасные части	359
7.1 Список принадлежностей	359
7.2 Список аксессуаров	359
8 Технические характеристики	360
8.1 Технические характеристики - Сетевой адаптер	362
9 Appendix	364
9.1 Уведомление об авторских правах и товарных знаках	364

1 Введение

1.1 Общая информация

1.1.1 Прочтите инструкцию перед использованием

В данном руководстве содержится важная информация о безопасной эксплуатации изделия. Пожалуйста, внимательно прочитайте данное руководство и ознакомьтесь с изделием перед использованием.

1.1.2 Назначение продукта

Портативный турбидиметр серии ТВ предназначен для анализа водных образцов, которые собираются в стеклянные кюветы и затем запаиваются. Кювета подготавливается к измерению с использованием тщательной техники, чтобы минимизировать помехи от пыли и царапин. После подготовки кювета помещается в прибор для измерения.

Прибор можно использовать в лаборатории или взять с собой в поле для проведения измерений на образцах по мере их сбора.

При транспортировке данного турбидиметра следует соблюдать осторожность. Если прибор берется с собой в поле, следует использовать футляр для переноски. Если прибор будет использоваться для нормативного применения, рекомендуется обратиться в местные органы власти, чтобы убедиться, что выбрана правильная модель прибора.

1.1.3 Разрешенное использование

Ответственность производителя и гарантия на повреждения аннулируются при неправильном использовании, несоблюдении данного руководства, использовании неквалифицированным персоналом или внесении несанкционированных изменений в изделие.

Производитель не несет ответственности за расходы или убытки, возникшие по вине пользователя или третьих лиц вследствие использования данного изделия, особенно в случаях неправильного использования изделия, неправильного применения или неисправностей при подключении изделия.

Производитель не несет ответственности за ошибки при печати.

1.1.4 Требования к безопасному использованию

Обратите внимание на следующие пункты для безопасного использования устройства:

- Если оборудование используется способом, не указанным производителем, защита, обеспечиваемая оборудованием, может быть нарушена.
- Изделие можно использовать только в соответствии с указанным выше разрешенным использованием.
- Питание изделия может осуществляться только от источников энергии, указанных в данном руководстве по эксплуатации.
- Изделие можно использовать только в условиях окружающей среды, указанных в данном руководстве по эксплуатации.
- Запрещается вскрывать или модифицировать изделие.

Запрещается использовать изделие, если:

- оно имеет видимые повреждения (например, после транспортировки)
- оно длительное время хранилось в неблагоприятных условиях (условия хранения, см. главу "Технические характеристики")

Необходимые условия для безопасного использования штекерного блока питания

Для безопасного использования соблюдайте следующие пункты:

- Перед использованием проверьте, нет ли видимых повреждений. При наличии повреждений не вводите в эксплуатацию.
- Используйте только в сухих помещениях.
- Обращайтесь с устройством только сухими руками.
- Разрешается использовать только блок питания, рекомендованный производителем.
- Запрещается вскрывать или модифицировать изделие.
- Для питания устройства можно использовать только кабель USB-C, рекомендованный производителем.

1.1.5 Соблюдайте инструкции

Руководство должно храниться рядом с изделием, чтобы вы всегда могли найти необходимую информацию.

1.1.6 Квалификация пользователя

Обслуживающий персонал должен уметь понимать и правильно применять этикетки безопасности и инструкции по технике безопасности на упаковках и вкладышах изделий.

Пользователь должен быть способен и иметь возможность прочитать и понять данное руководство, чтобы ознакомиться с правилами обращения и обеспечить безопасное использование.

1.1.7 Обращение с опасными химическими веществами

При использовании данного продукта могут существовать химические и/или биологические опасности. Соблюдайте все законы, правила и протоколы при использовании данного продукта.

При разработке продуктов компания Lovibond уделяет пристальное внимание безопасности. Некоторых опасностей, связанных с опасными веществами, избежать невозможно. Если используются самостоятельно изготовленные тесты или растворы, ответственность за любые риски, вызванные этими тестами или растворами, лежит на пользователе (личная ответственность).

Для вашей собственной защиты, при стандартах мутности более 5 NTU, рекомендуется использовать защитные перчатки или очки. Соблюдайте соответствующую инструкцию по технике безопасности.

В паспортах безопасности химических веществ содержатся все инструкции по безопасному обращению, возникающим опасностям, профилактическим действиям и действиям в опасных ситуациях.

1.1.8 Инструкции по утилизации

Утилизируйте батареи и электрооборудование на подходящем объекте в соответствии с местным законодательством. Выбрасывать батарейки вместе с бытовыми отходами запрещено законом. В Европейском Союзе по окончании срока службы устройства батареи утилизируются в специализированных пунктах приема вторсырья.



Приборы, отмеченные этим символом, нельзя выбрасывать в обычные бытовые отходы.

RU

1.2 Список всех символов, используемых в документе

Следующие символы используются в данном руководстве для обозначения разделов, требующих особого внимания:



Опасность!

Существует опасность, которая может привести к смерти или серьезным травмам, если ее не избежать!



Предупреждение!

Неправильное обращение с некоторыми реагентами может нанести вред вашему здоровью. В любом случае следуйте информации на этикетках безопасности на упаковке, инструкциям по безопасности во вкладыше к упаковке и имеющемуся паспорту безопасности. Необходимо точно соблюдать указанные там защитные меры.



Внимание!

Существует опасность, которая может привести к травмам легкой или средней тяжести.

1.3 Сокращения

Сокращения	Определение
NTU	Nephelometric Turbidity Unit
FNU	Formazin Nephelometric Units
mg/l	Миллиграмм на литр

2 Обзор продукции

2.1 Сертификация

EMC Кондуктивные и радиационные излучения	CISPR 11 (Пределы класса A)	знак CE
EMC Иммунитет	EN 61326-1 (Промышленные ограничения)	знак CE
Безопасность	EN 61010-1	Знак безопасности TÜV
FCC	FCC Класс A	знак FCC

RU

Уведомление FCC класса A

Данное устройство соответствует части 15 правил FCC. Эксплуатация осуществляется при соблюдении следующих двух условий:

- Данное устройство не должно создавать вредных помех.
- Это устройство должно принимать любые помехи, включая помехи, которые могут вызвать нежелательную работу.

Примечание: Данное оборудование было протестировано и признано соответствующим ограничениям для цифровых устройств класса A в соответствии с частью 15 правил FCC. Эти ограничения разработаны для обеспечения разумной защиты от вредных помех при эксплуатации оборудования в коммерческой среде. Данное оборудование генерирует, использует и может излучать радиочастотную энергию и, если оно установлено и используется не в соответствии с инструкцией по эксплуатации, может создавать вредные помехи для радиосвязи. Эксплуатация данного оборудования в жилой зоне может вызвать вредные помехи, в этом случае пользователь будет обязан устранить помехи за свой счет.

Экранированные кабели



Подключения между системой и ее периферийными устройствами должны выполняться с помощью экранированных кабелей для соблюдения ограничений на радиочастотное излучение FCC.

Внимание!

Модификации



Любые изменения, внесенные в данное устройство и не одобренные компанией Tintometer, могут привести к аннулированию полномочий, предоставленных пользователю Федеральной комиссией по связи (FCC) для эксплуатации данного оборудования.

Внимание!

RU

Уведомление о DOC класса A - Avis DOC, класс A

Данный цифровой аппарат класса A соответствует всем требованиям Канадских правил по оборудованию, вызывающему помехи.

2.2 Характеристики

Лабораторная точность сочетается с портативностью

Серия Lovibond® ТВ устраняет сложности, связанные с измерением мутности. Эта новая технология обеспечивает высочайший уровень точности, операционной и нормативной эффективности.

- Интерфейс с сенсорным экраном для простоты управления
- Инструкции с картинками помогут пользователю пройти все этапы процесса и избежать ошибок.
- Простые протоколы управления данными для обеспечения их целостности

2.3 Описание продукта

Мутность - это проявление оптических свойств образца, из-за которых световые лучи рассеиваются и поглощаются, а не проходят по прямой линии через жидкий образец. В воде мутность часто вызвана присутствием таких веществ, как глина, ил, мелкодисперсные органические вещества, планктон, другие микроскопические организмы, органические кислоты и пигменты. Измерение мутности используется для мониторинга процессов, которые удаляют или изменяют концентрацию частиц в растворах, например, при производстве питьевой воды. Эти турбидиметры Lovibond® разработаны таким образом, чтобы сочетать высокую точность и высокую чувствительность, которые ожидаются от лабораторного турбидиметра, с портативностью.

2.4 Вид на прибор

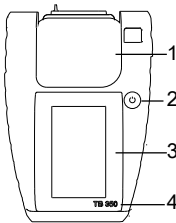
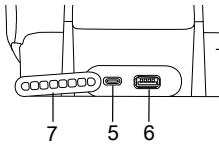
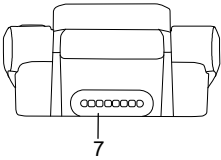
Позиция	Описание	Функция
	<p>1. Крышка</p> <p>2. Кнопка питания</p> <p>3. Сенсорный экран</p> <p>4. Номер модели</p>	<p>При поднятии позволяет пользователю поместить ячейку с образцом в прибор для снятия показаний.</p> <p>Включает и выключает питание прибора.</p> <p>Отображает пользовательский интерфейс прибора.</p> <p>Определяет версию прибора.</p>
	<p>5. Порт USB-C</p> <p>6. Порт USB-A</p>	<p>Подает питание на прибор от внешнего источника или перезаряжает аккумуляторный блок (если установлен).</p> <p>Поддерживает внешнее устройство USB-A для таких функций, как передача данных или резервное копирование.</p>
	<p>7. Уплотнение</p>	<p>Используется для закрытия портов USB-C и USB, когда соединения не используются.</p>

3 Ввод в эксплуатацию

3.1 Условия эксплуатации

Прибор может использоваться в любой внутренней или внешней среде, которая считается безопасной для проведения анализа оператором.

Прибор может принимать водные образцы от 0 до 70 °С.

При выполнении измерения прибор должен находиться на уровне $\pm 15^\circ$.

Для достижения наилучших результатов измерения прибор должен быть установлен на ровной поверхности.

RU

3.2 Содержание поставки

Внимательно осмотрите все предметы, чтобы убедиться, что все детали из приведенного ниже списка присутствуют и никаких видимых повреждений во время транспортировки не произошло. Если есть какие-либо повреждения или что-то отсутствует, немедленно свяжитесь с местным дистрибьютором.

ТВ	350 IR	350 WL
Инструмент	X	X
Силиконовое масло, 15 мл	X	X
Ткань из микрофибры	X	X
2 x ячейки для образцов	X	X
Отвертка	X	X
Кисть	X	X
Футляр со вставкой	X	X
Краткое руководство пользователя	X	X
Сертификат соответствия	X	X
Гарантийный буклет	X	X
4 x батарейки AA	X	X
Перезаряжаемый аккумуляторный блок		
Кабель USB-C		
Источник питания переменного тока		
Адаптер для вилок США, Великобритании и ЕС		
T-CAL® Standard, 5 NTU	X	X
T-CAL® Standard, 20 NTU	X	X
T-CAL® Standard, 800 NTU	X	X
T-CAL® Standard, 2000 NTU		X
T-CAL® Standard, 4000 NTU	X	X

3.3 Установка и замена батареек

При использовании аккумуляторов

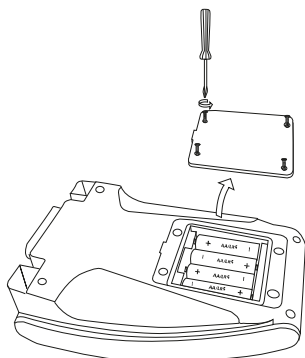

Шаг	Описание
1	С помощью отвертки открутите четыре винта на задней панели прибора и снимите панель.
2	Вставьте четыре батарейки AA в правильной ориентации.
3	Прикрепите панель обратно к прибору.



Внимание!

- Используйте только разрешенный тип: щелочную марганцевую батарейку, LR6, с напряжением 1,5 В.
- Извлекайте разряженные батареи из устройства как можно скорее.
- Если устройство не используется в течение длительного времени, извлеките из него батарейки.

При использовании перезаряжаемых батарей

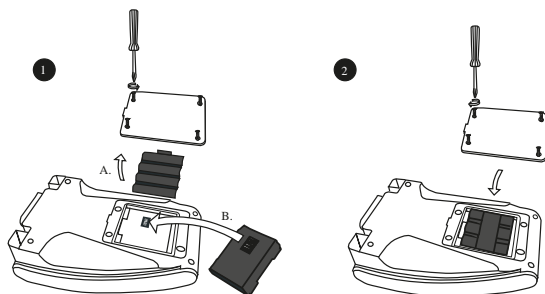

Шаг	Описание
1	С помощью отвертки выкрутите четыре винта на задней панели прибора, снимите панель и лоток для батарей.
2	Вставьте аккумуляторный блок в правильной ориентации.
3	Прикрепите панель обратно к прибору.

**Предупреждение!**

Аккумуляторный блок (19820-011) совместим только с приборами с серийным номером 23041000 и выше. Использование батарейного блока для приборов с серийными номерами до 23041000 может привести к перегреву прибора во время зарядки. Такой перегрев может привести к неправильным показаниям и повреждению прибора, поэтому его следует избегать. Для приборов с серийными номерами ниже 23041000, пожалуйста, свяжитесь с Lovibond® для получения подробной информации об использовании данного аксессуара.

4 Операция

4.1 Первый запуск



1. Экран приветствия

Начальный экран, который пользователь видит при первом включении

Нажмите кнопку >



2. Выберите язык

Выберите нужный язык для настройки

Нажмите кнопку >



3. Установите дату и время

Выберите 12- или 24-часовой формат

Изменяйте значения с помощью стрелок вверх и вниз

Нажмите кнопку >



4. Пароль

Установите выбранный пользователем пароль для реализации функций безопасности на приборе

Нажмите кнопку сохранения

Если пароль не требуется, выберите Пропустить

Нажмите кнопку >



5. Единицы измерения по умолчанию

Выберите нужный тип единиц для установки

Нажмите кнопку >



6. Контактная информация

Введите информацию о владельце прибора

Нажмите кнопку сохранения

Если подробная информация не требуется, выберите Пропустить

Нажмите кнопку >



7. Экран сводки

Просмотр начальных настроек.

Нажмите <, чтобы изменить настройки перед продолжением

Нажмите >, чтобы перейти к главному экрану

Пользователь может выбрать задачу для выполнения с помощью прибора

4.2 Общие принципы работы

Конструкция портативных турбидиметров серии ТВ разбита на соответствующие функциональные компоненты, которые обсуждаются подробно. К ним относятся источник света, 90-градусная ловушка рассеянного света, детектор рассеянного света, пробирка для образца турбидиметра и то, как эти ключевые компоненты работают вместе для получения результата мутности.

RU

Упрощенная оптическая конфигурация портативных турбидиметров серии ТВ.

На этом рисунке показан путь падающего света и вид детектора рассеянного света под углом 90°.

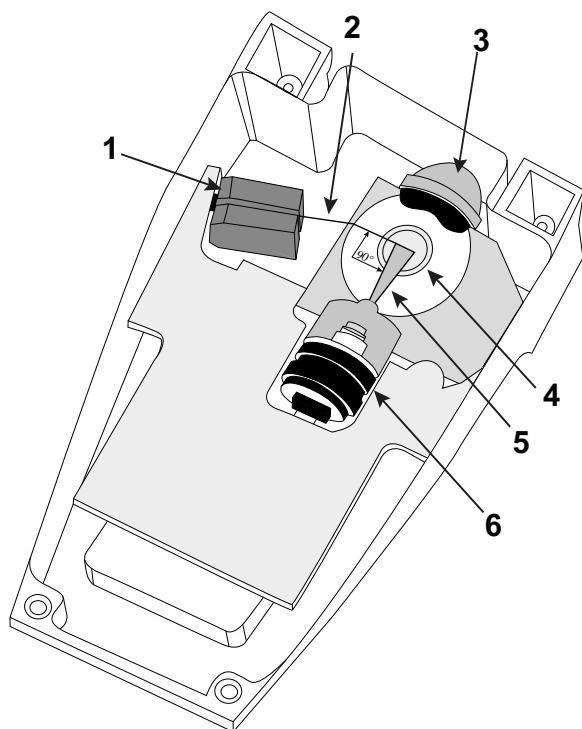



- 1 Осветитель (светодиод и оптика)
- 2 Путь падающего света
- 3 90° Ловушка для рассеянного света
- 4 Пробирка для образца
- 5 Рассеянный свет (обзор детектора 10°-20°)
- 6 Детектор рассеянного света и оптика



4.3 Список элементов управления и их функции

4.3.1 Список элементов управления и их функции



Описание	Функция
1 Строка состояния	Отображает значки и ярлыки, которые являются универсальными, включая Время, Bluetooth®, USB, Безопасность, Источник света и Питание.
2 Зона действий	Область, отображающая шаги приложения и взаимодействие.
3 Домашний бар	Используется в основном для навигации, чтобы начать, сохранить или отменить действия и вернуться домой.



Икона	Описание
	Режим измерения
	Режим калибровки
	Режим верификации

Икона	Описание
	Журналы данных
	Bluetooth-соединение с технологическим турбидиметром PTV (недоступно для ТВ 350)
	Настройки прибора

4.3.2 Список элементов управления и их функции

Икона	Описание	Функция
	Имя приложения	Название приложения, которое пользователь использует в данный момент.
	Время	Время устанавливается пользователем при первоначальной настройке или в настройках прибора. Доступен 12-часовой или 24-часовой формат.
	USB	Если отображается, это означает, что к устройству подключен модуль USB.
	Значок Bluetooth - обычный ²⁾	Если отображается, модуль Bluetooth® подключен.
	Значок Bluetooth - со стрелками ²⁾	Если отображается, модуль Bluetooth® подключен и активно взаимодействует с PTV или приложением AqualX.
	Источник красного света - заполнен	Прибор содержит красный светодиодный источник света; свет включается для измерения.
	Красный Источник света - контур	Прибор содержит красный светодиодный источник света; измерение не активно.
	Белый Источник света - заполненный	Прибор содержит белый светодиодный источник света; свет включается для измерения.

Икона	Описание	Функция
	Белый Источник света - контур	Прибор содержит белый светодиодный источник света; измерения не активны.
	Источник инфракрасного света - включено	Прибор содержит инфракрасный светодиодный источник света; свет включается для измерения.
	Infrared Light Source – Off	Прибор содержит инфракрасный светодиодный источник света; измерение не активно.
	Источник лазерного излучения - заполненный ¹⁾	Прибор содержит лазерный светодиодный источник света; свет включается для измерения.
	Источник лазерного излучения - конспект ¹⁾	Прибор содержит лазерный светодиодный источник света; измерения не активны.
	Зарядка аккумулятора от сети переменного тока	Аккумулятор переменного тока заряжается.
	Значок питания от сети переменного тока	Указывает, что прибор питается от сети переменного тока.
	Питание от батареи - зеленый	Указывает на 100% ресурс оставшейся батареи.
	Питание от батареи - Желтый	Указывает на то, что осталось 75% заряда батареи.
	Питание от батареи - Апельсин	Указывает на то, что осталось 50% заряда батареи.

Икона	Описание	Функция
	Питание от батареи - Красный	Указывает на то, что осталось 25% заряда батареи.
	Крышка измерительной камеры открыта	Указывает, открыта ли крышка измерительной камеры.
	Крышка измерительной камеры закрыта	Указывает, закрыта ли крышка измерительной камеры.

¹⁾ только ТВ 600

²⁾ не ТВ 350

4.3.3 Строка состояния

Икона	Описание	Функция
	Главная кнопка	Возвращает пользователя на главный экран.
	Главная кнопка - Заблокировано	Защита активна; пароль был включен и требуется для выполнения определенных функций.
	Главная кнопка - Разблокированный	Безопасность неактивна; никакие функции не блокируются для пользователя.
	Кнопка сохранения	Сохраняет содержимое, отображаемое в активной области.
	Кнопка настроек	Открывает меню настроек приложения.
	Кнопка экспорта	Экспортирует журнал(ы), отображаемый(ые) в активной области.
	Кнопка измерения	Запускает или Начиает или Иницирует измерение.

Икона	Описание	Функция
	Кнопка измерения - с Bluetooth ²⁾	Выполняет измерение при подключении к устройству РТВ.
	Кнопка обновления Bluetooth ²⁾	Обновляет список доступных устройств РТВ в непосредственной близости от прибора.
	Кнопка отмены	Дает возможность отменить текущую деятельность в активной области.
	Правый шеврон	Переход к следующему шагу в рамках процесса.
	Левый шеврон	Возврат к предыдущему шагу в рамках процесса.

²⁾ не ТВ350

4.4 Измерение

4.4.1 Обзор измерений

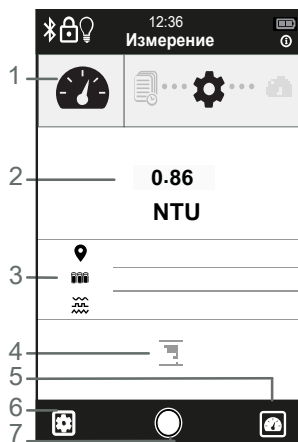

Описание	Функция
1 Планка для нанесения	Путь навигации, помогающий пользователю пройти все этапы процесса.

Описание	Функция
2 Измеренное значение	Отображение результата измерения с единицами измерения.
3 Настройки	Отображаются настройки, применяемые при измерении.
4 Кнопка журнала	Создает журнал при нажатии.
5 Кнопка измерения	При нажатии запускает измерение.
6 Кнопка настроек	Используется для изменения настроек.
7 Главная кнопка	Возвращает пользователя на главный экран.

4.4.2 Выполнение измерения

Пожалуйста, подготовьте образцы ячеек, входящие в комплект поставки, перед измерением. Убедитесь, что на ячейках нет пятен, царапин или дефектов.

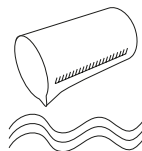

1. Соберите пробу

Убедитесь, что проба репрезентативна (хорошо перемешана).
Стеклопосуда должна быть без пятен, царапин и других дефектов.
Перед взятием пробы ополосните сосуд для сбора пробы не менее двух раз.



2. Подготовьте пробирку

Протрите безворсовой салфеткой внешнюю поверхность пробирки.
Используйте силиконовое масло, чтобы минимизировать отражение рассеянного света.



3. Вставьте пробирку в прибор

Убедитесь, что образец не содержит пузырьков.
Медленно инвертируйте для перемешивания. Не встряхивайте.



4. Закройте крышку

Измерения без установленной крышки не допускаются.



5. Проверьте настройки

Убедитесь в правильности настроек измерения. Настройки для измерения не могут быть изменены после проведения измерения.



6. Нажмите кнопку измерения

Запускает измерение.



7. Журнал данных

Введите Журналы данных для сохранения измерений.



8. Сохранить измерение

При желании нажмите кнопку Save Button, чтобы создать журнал измерений.



9. пауза

Приостанавливает измерение в режиме "непрерывный" измерения.



- Не вносите в измерительную камеру никаких предметов, кроме ковет, предназначенных для измерений.
- Не вносите в камеру никаких жидкостей.

Внимание!

4.4.3 Советы по измерению

Индексирование пробирки: Это лучше всего делать с пробиркой, заполненной водой, отфильтрованной через фильтр 0,2 мкм.

- Нажмите кнопку "Измерение".
- Вращайте образец. Вращая пробирку, определите самое низкое показание.
- Когда положение будет определено, остановите измерение. Пометьте пробирку.
- Прежде чем приступить к дополнительным измерениям, убедитесь, что режим измерения обновлен, если это необходимо.
- Рекомендуется индексировать пробирку с образцом, если на стеклянной посуде есть заметные царапины или ямки.

Использование силиконового масла

- Держите пробирку только за верхнюю треть.
- Протрите пробирку прилагаемой салфеткой, чтобы удалить воду, пыль и отпечатки пальцев.
- Смажьте внешнюю поверхность флакона силиконовым маслом.
 - Нанесите очень тонкий слой силиконового масла на боковую поверхность флакона. Равномерно распределите шарик масла по дну 2/3 флакона.
 - Вытрите силикон из флакона путем вращения флакона о чистую, непыльную ткань.
- Смазывание ячеек маслом крайне важно и рекомендуется при измерении образцов с ожидаемой мутностью ниже 0,5 NTU.

Образцы, содержащие избыточное количество пузырьков

- Дайте образцу отстояться в течение минимум пяти минут.
- Аккуратно переверните образец два-три раза, чтобы ресуспендировать мутность.
- Поместите в прибор и действуйте в соответствии с инструкциями.

Другие примечания

- Не рекомендуется использовать ультразвуковые ванны. Ультразвуковая энергия может изменить распределение частиц.
- Используйте режим быстрой установки для образцов с высокой концентрацией песка или частиц высокой плотности.

4.4.4 Настройки измерений

Нажмите кнопку Settings (Настройки), чтобы перейти в режим настроек измерений.

Иконка	Описание	Опция	Функция
	Режим	Одиночный	Нажмите для запуска теста
		Непрерывный ¹⁾	Измерение обновляется каждые X секунд, пока не будет остановлено.
		Fast Settling	Рекомендуется для образцов с быстрым оседанием.
	Местонахождение	Включено По умолчанию	Используется, если пользовательский идентификатор не задан.
		Пользовательский	Описание места измерения, задаваемое пользователем и пределы измерений.
	Среднее значение сигнала	включено	Если включено, можно настроить до 255 измерений. Функцию следует использовать, если измерения нестабильны.
		выключено	деактивирован
	Идентификатор образца	По умолчанию	Используется, если пользовательский идентификатор не задан.
		Пользовательский	Уникальный идентификатор образца; выбирается пользователем.

¹⁾ не TB350

4.5 Описание отдельных этапов работы или отдельных разделов пользовательского интерфейса

4.5.1 Обзор калибровки



Описание	Функция
1 Планка для нанесения	Путь навигации, помогающий пользователю пройти все этапы процесса.
2 Калибровочная кривая	Указывает тип калибровки.
3 Стандартный набор	Уникальный идентификатор стандартного набора.
4 Кнопка настроек	Используется для изменения настроек.
5 Главная кнопка	Возвращает пользователя на главный экран.
6 Следующая кнопка	Переход к следующему экрану.

4.5.2 Выполнение калибровки

Перед калибровкой подготовьте стандарты T-CAL[®], входящие в комплект поставки. Убедитесь, что на флаконах T-CAL[®] нет пятен, царапин или пятен.

- Стандарты T-CAL[®] для ТВ 350 IR: 20 / 800 / 4000 NTU
- Стандарты T-CAL[®] для ТВ 350 WL: 20 / 800 / 2000 / 4000 NTU



- 1. Регулировка нуля:**
Выполняет установку нуля.

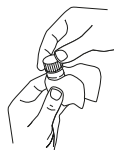

- 2. Подготовьте пробирку:**
При необходимости смажьте пробирку маслом.



- 3. Вставить стандарт:**
Вставка стандартного значения, указанного на экране.
Пользователь вставляет серию различных стандартов мутности для завершения калибровки.



- 4. Модальный:**
Представляет собой активный процесс.





- 5. Сводка журнала:**
Нажмите кнопку Save (Сохранить), чтобы сохранить журнал.
Нажмите кнопку Cancel (Отмена), чтобы вернуться к началу процесса калибровки.

4.5.3 Настройки калибровки



Нажмите кнопку Настройки, чтобы перейти в режим настроек.

Иконка	Описание	Опция	Функция
	Калибровочная кривая	T-CAL®	Выбирает готовый стабилизированный стандарт формазина в заранее определенных концентрациях
		Формазин	Выбор подготовленного пользователем стандарта формазина в заранее определенных концентрациях
	Стандартный набор	По умолчанию	Используется, если уникальный идентификатор не задан.
		Уникальный	Уникальный идентификатор стандартного набора.

**Напоминание¹⁾**

включено Напоминает пользователю о необходимости проведения калибровки. Возможность принудительной калибровки перед проведением дополнительных измерений.

выключено Настройка по умолчанию.

**Калибровка по умолчанию**

Опция возврата к заводским настройкам калибровки.

**Постоявая верификация**

включено Требуется от пользователя проведения верификации после завершения калибровки.

выключено Настройка по умолчанию.

**"Калибровочный контролер"**

включено (По умолчанию) Во время процедуры калибровки, если отдельный стандарт выходит за пределы допуска, пользователь должен исправить стандарт, чтобы продолжить или отменить процедуру калибровки. Эта функция предотвращает ошибку калибровки из-за неправильного стандарта. На экране журнала будет строка для Calibration Checker, и она будет показывать состояние "On" или "Enabled".

выключено Во время процедуры калибровки, если отдельный стандарт выходит за пределы допуска, пользователь не будет уведомлен о том, что калибратор вышел за пределы заданного диапазона Тинтометров. На экране журнала будет строка для Calibration Checker, и она будет показывать состояние "Off" или "Disabled".

¹⁾ не TB350

4.6 Верификация

4.6.1 Обзор верификации

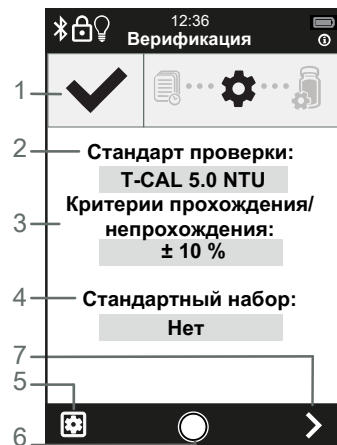

Описание	Функция
1 Планка для нанесения	Путь навигации, помогающий пользователю пройти все этапы процесса.
2 Verification standard	Значение измеряемого стандарта.
3 Pass / Fail	Допуск, используемый для определения того, прошла или не прошла проверка.
4 Стандартный набор	Уникальный идентификатор стандартного набора.
5 Кнопка настроек	Используется для изменения настроек.
6 Главная кнопка	Возвращает пользователя на главный экран.
7 Следующая кнопка	Переход к следующему экрану.

4.6.2 Выполнение верификации

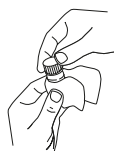

1. Подготовьте пробирку

При необходимости смажьте пробирку маслом.



3. Вставить стандарт

Вставка стандартного значения, указанного на экране.



4. Модальный

Представляет собой активный процесс.



5. Сводка журнала

Нажмите кнопку Сохранить, чтобы сохранить журнал.
Нажмите кнопку Отмена, чтобы вернуться к началу процесса верификации.

RU

4.6.3 Настройки верификации



Нажмите кнопку Настройки, чтобы войти в режим настроек.

Иконка	Описание	Опция	Функция
	Стандарт	T-CAL 5.0 NTU	Выбирает готовый стабилизированный стандарт формазина в концентрации 5,0 NTU.
		Подготовлено пользователем	Выбор подготовленного пользователем стандарта в диапазоне от 1 до 1000 NTU.
	Критерии Pass/ Fail	$\pm 10\%$	Допуск, используемый для определения того, прошла или не прошла проверка.
		$\pm 5\%$	
		± 0.05 NTU	
		± 0.10 NTU	
	Напоминание ¹⁾	включено	Напоминает пользователю о необходимости проверки.
		выключено	Настройка по умолчанию.

¹⁾ не TB350

4.7 Журналы

4.7.1 Выбор типа журнала



Нажмите кнопку Тип журнала в области действий для доступа к журналам.

Панка для нанесения:



Журналы измерений:

Отображает все записанные измерения.



Журналы калибровки:

Отображает все записи калибровки.



Журналы поверки:

Отображает все записи о поверке.

¹⁾

Журналы режима GLP:

Отображает записи о включении или выключении режима GLP.

¹⁾ не ТВ 350

4.7.2 Извлечение журнала



1. Выберите тип журналов

Отображает записи того типа журнала, который пользователь хотел бы просмотреть.



2. Экспортировать отдельные журналы

Если выбрана одна запись, этот журнал экспортируется в формате CSV.

Экспортируются все детали, связанные с журналом.



3. выберите метод передачи

USB: Экспорт протокола на USB-накопитель.



Bluetooth[®] ¹⁾: Экспорт журнала в мобильное приложение AquaLX.

Недоступно на ТВ 350.

Примечание: для подключения к порту USB-A требуется внешний донгл Lovibond[®] Bluetooth[®].

¹⁾ не ТВ 350

4.8 Настройки прибора



Нажмите кнопку Настройки, чтобы перейти в режим настроек.

Иконка	Описание	Опция	Функция
	Безопасность	включить	Настройка, проверка и изменение пароля.
		Отключить	Настройка по умолчанию.
	Настройки питания	Яркость экрана	Настройка яркости экрана.
		Выключение подсветки	На сайте 20 секунд 30 секунд 1 минута* 5 минут
		Система выключена	На сайте 1 минута 2 минуты 5 минут 15 минут* Примечание: При использовании кабеля питания USB-C для отключения системы устанавливается значение "Выкл." до тех пор, пока устройство не будет отключено от сети, а затем возвращается к выбранной опции.
	Bluetooth¹⁾	включить	Включает Bluetooth® при наличии аппаратного обеспечения.
		Отключить	Настройка по умолчанию.

RU



**Ярлыки
USB¹⁾**

включить

Если эта функция включена, при подключении USB-накопителя пользователю открывается модальное окно, в котором предлагается выбрать параметры "передача журналов" или "резервное копирование/восстановление". При выборе опции пользователь переходит к соответствующей функции.

Отключить

Настройка по умолчанию; пользователи должны получить доступ к настройкам "Журналы" или "Резервное копирование/восстановление" при подключенном USB-накопителе.



Язык

Выберите язык.



**Дата /
время**

Выберите отображаемое время и формат.



Резервное копирование /настроек¹⁾ восстановление Резервное копирование всех настроек

Возможность сохранения настроек на локальной SD-карте или на внешнем USB-накопителе.

Восстановить все настройки¹⁾

Восстанавливает ранее сохраненные настройки, сохраненные на локальной SD-карте или внешнем USB-накопителе.

Восстановление заводских настроек

Сброс всех настроек к заводским значениям по умолчанию. Сохраненные журналы остаются доступными.



Единица измерения

NTU

Выберите отображаемую единицу измерения.

FNU

Определяет тип единицы

mg.l Kaolin

отображаемого

mg.l PSL

значения измерения.

Степени

NTU - значение по умолчанию.

mNTU¹⁾

mFNU¹⁾

Пользовательский¹⁾

Позволяет задавать тип единицы измерения, определяемый пользователем, и возможность установки коэффициента на основе значений NTU/FNU.

GLP¹⁾

включить

Устанавливает протокол целостности данных для лабораторий, соблюдающих надлежащую лабораторную практику.

Отключить

Настройка по умолчанию.

RU



Владелец

Контактные данные владельца прибора.



Связаться

Контактная информация представительств Lovibond®.



Об

О компании Lovibond®.

¹⁾ не ТВ 350

* Настройка по умолчанию

5 Техническое обслуживание

5.1 Повторный график технического обслуживания

Задание	Сделать	Не делать
1. Чистая измерительная камера 2. Очистить дисплей прибора	1. Перед измерением убедитесь, что измерительная камера чистая и сухая. Для удаления загрязнений используйте сухую ткань из микрофибры. 2. Протрите сенсорный экран сухой или слегка влажной тканью из микрофибры.	1. Распылять или заливать любую жидкость непосредственно в измерительную камеру. 2. Измерьте образец, который не плотно укупорен.
Очистить наружный корпус	Очистите внешний корпус мягким раствором моющего средства или разбавленным спиртом.	
Хранение и уход за ячейками для образцов	После использования всегда промывайте флаконы водой без мутности.	Используйте избыток силиконового масла, которое не было вытерто из флакона. Достаточно одной бусинки.
	Заполните флакон деионизированной водой. Закройте флакон крышкой, чтобы предотвратить образование водяных пятен.	Оставьте ячейки с образцами в незакрытом виде для высыхания на воздухе.
	Вытрите насухо внешнюю поверхность флакона салфеткой из микрофибры.	Используйте любой флакон с видимыми дефектами, включая ямки, царапины или трещины.
Замена батареи	Рекомендуется извлекать батареи, если прибор хранится более 30 дней, чтобы предотвратить утечку батареи.	Используйте батарею неуказанного типа.

Задание	Сделать	Не делать
Калибровка	Калибруйте по мере необходимости при следующих условиях: <ol style="list-style-type: none"> 1. Сбой верификации. 2. Проводится техническое обслуживание оптических или электронных систем. 3. В соответствии с требованиями региональных регулирующих органов. 	Использовать стандарты с истекшим сроком действия.
Тщательно следуйте инструкциям по подготовке и использованию стандартов.		
Верификация	Проверьте работу прибора при следующих условиях: <ol style="list-style-type: none"> 1. После выполнения калибровки. 2. В соответствии с внутренними процедурами контроля качества. 3. В соответствии с требованиями региональных регулирующих органов. 	Использовать стандарты с истекшим сроком действия.
Тщательно следуйте инструкциям по подготовке и использованию стандартов.		
Соединитель / уплотнение	Убедитесь, что прокладка разъема закреплена, когда вы не находитесь в лабораторных условиях.	Не храните устройство без подсоединенной прокладки.
Транспортировка или поддержка прибора с помощью соединительного кабеля.		



Предупреждение!

Неправильное обращение с некоторыми реагентами может нанести вред вашему здоровью. В любом случае следуйте информации на этикетках безопасности на упаковке, инструкциям по безопасности во вкладыше к упаковке и имеющемуся паспорту безопасности. Необходимо точно соблюдать указанные там защитные меры.

6 Устранение неполадок

6.1 Сообщения об ошибках и что делать

Симптом	Возможная причина	Решение
За пределы диапазона	Мутность образца находится за пределами диапазона измерения прибора.	<ul style="list-style-type: none"> Разбавьте образец Проверьте калибровку с помощью стандарта высокого диапазона.
Под диапазоном	Мутность образца ниже предела обнаружения прибора.	<ul style="list-style-type: none"> Повторите измерение рассеянного света (установка нуля), как предписано, и убедитесь, что крышка образца закрыта. Повторите калибровку после определения рассеянного света.
Прибор не включается.	Батареи неисправны Батареи вставлены неправильно	<ul style="list-style-type: none"> Замените батареи на полный новый комплект.
Кнопка "Сохранить" для функции не появляется, поэтому журнал не может быть создан.	Необходимая информация отсутствует.	Убедитесь, что инициалы пользователя и все остальные обязательные поля заполнены надлежащим образом.
Прибор не производит измерения	Крышка не закрыта.	Закройте крышку.
Уведомление о низком заряде батареи	Аккумулятор находится ниже 20%.	Замените или перезарядите батареи.
Настройки прибора недоступны для пользователя	Протокол безопасности устройства активен.	Введите пароль для разблокировки функций настройки и калибровки.
Ошибка калибровки	Пробирки с образцами не были очищены перед калибровкой.	<ul style="list-style-type: none"> Повторно промойте флаконы для проб, используя процедуру, указанную в руководстве. Храните пробирки в соответствии с инструкцией. Проверьте срок годности стандарта

Симптом	Возможная причина	Решение
Ошибка калибровки	Калибровочные стандарты были запущены в неправильном порядке.	Повторите калибровку с эталонами от наименьшего к наибольшему значению.
Ошибка калибровки	Калибровочные стандарты не были надлежащим образом перемешаны.	Смешайте стандарты в соответствии с инструкциями непосредственно перед выполнением калибровки.
Ошибка калибровки	Калибровочные стандарты, подготовленные для неправильных значений мутности.	Повторите приготовление калибровочных стандартов, убедившись в правильности разведений.
Ошибка верификации	Верификация выходит за границы Ошибки.	<ul style="list-style-type: none"> • Смешайте поверочный эталон перед поверкой. • Проверьте критерии "прошел/не прошел", чтобы убедиться, что критерии не жестче, чем точность эталона, и соответствующим образом скорректируйте эти критерии. • Проверьте срок годности стандарта

7 Аксессуары и запасные части

7.1 Список принадлежностей

Заголовок		Номер заказа
ASM, 3-элементный аккумуляторный блок, HR6, AA, Ni-MH	TB350 IR, TB350 WL	19820-011
Батареи (AA), комплект из 4 штук	TB350 IR, TB350 WL	1950025
Блок питания для TB series	TB350 IR, TB350 WL	19820-170
Измерительные кюветы с черной крышкой, высота 55 мм, ø 24 мм, комплект из 12 штук	TB350 IR, TB350 WL	197655
Кабель USB-C 1 м, USB-C - A	TB350 IR, TB350 WL	19820-081
Набор эталонов мутности T-CAL (5, 20, 800, 2000, 4000 ЕНМ)	TB350 WL	194152
Набор эталонов мутности T-CAL (5, 20, 800, 4000 ЕНМ)	TB350 IR	194154
Силиконовое масло	TB350 IR, TB350 WL	194295
Стойка для 6 круглых кювет Ø 24 мм	TB350 IR, TB350 WL	418951
Чистящая салфетка	TB350 IR, TB350 WL	197635
Щетка, длина 11 см	TB350 IR, TB350 WL	380230
Эталон T-CAL®, 4000 ЕНМ, 125 мл	TB350 IR, TB350 WL	48012912
Эталон T-CAL®, 4000 ЕНМ, 500 мл	TB350 IR, TB350 WL	48012950

7.2 Список аксессуаров

Описание	Номер детали
Чехол для переноски	19820-130
Крышка, камера для образца	19820-095
Крышка, батарейный отсек	19820-098
Заглушка, эластомерная, IP67, I/O	19820-084
Вставка для 4 батареек типа AA	19820-012

8 Технические характеристики

Model	Model WM-040-1004 (IR)
	Model WM-040-1001 (WL)
Источник света	Инфракрасный светодиод (860 нм)
	Белый светодиод
Соответствие нормативным требованиям	ISO 7027
	Одобрено EPA (альтернатива US EPA 180.1)
Принцип измерения	Нефелометрического (Multipath 90° BLAC)
Диапазон измерений	0.01 - 4000 NTU (FNU)
Разрешение измеренных значений	Автоматический диапазон: 0.01-9.99: 0.01 NTU ; 10.0-99.9: 0.1 NTU ; 100-4000: 1 NTU
Точность	± 1,8 % от показаний + рассеянный свет
Повторяемость	< 1 % или ± 0,01 NTU
Рассеянный свет	< 0.014 NTU
Отображаемая единица	NTU, FNU, градусы, мг/л Каолин, мг/л PSL
Время реакции	7 секунд
Режимы чтения	Одиночный, усреднение сигнала, Fast-Settling
Параметры калибровки	Полнодиапазонная калибровка от 0 до 4000 NTU
Детектор	Кремниевый фотодиод
Режим соотношения	Да
Необходимый объем образца	10 mL (0.4 oz)
Дисплей	Полноцветный сенсорный экран
Размер дисплея	55 x 95 mm (Ш x В)
Интерфейсы	<ul style="list-style-type: none"> • USB-A • USB-C
Регистратор данных	250 измерений, все калибровки, верификации и заводские восстановительные работы
Формат передачи данных	.csv
Режим энергосбережения	Да

Auto – OFF	Выбираемый
Электроснабжение	<ul style="list-style-type: none"> • 3 NiMH-battery pack (AA) • 4 batteries (AA) • Universal (90 - 240 VAC), via external power supply
Окружающие условия	<p>Температура: 0 - 50 °C (32 - 122 °F) Влажность: 0 - 90 % при 30 °C, без конденсации влаги Влажность: 0 - 80 % при 40 °C (104 °F), без конденсации влаги Влажность: 0 - 70 % при 60 °C, без конденсации влаги</p>
Класс защиты	IP 67 (прибор)
Соответствие	<ul style="list-style-type: none"> • CE • CSA • FCC A • RoHS • TÜV • UL • WEE
Языки интерфейса пользователя	<ul style="list-style-type: none"> • Английский • Голландский • Испанский • Китайский • Немецкий • Польский • Португальский • Турецкий • Французский • Японский
Языки краткого руководства	<ul style="list-style-type: none"> • Английский • Голландский • Испанский • Итальянский • Китайский • Немецкий • Португальский • Русский • Турецкий • Французский

Языки руководства по эксплуатации	<ul style="list-style-type: none"> • Английский • Голландский • Испанский • Итальянский • Китайский • Немецкий • Португальский • Русский • Турецкий • Французский
-----------------------------------	---

Размеры	155 x 83 x 225 mm
Вес	804 g (898 g with four AA alkaline batteries)
Вес с упаковкой	(898 g with four AA alkaline batteries)

**Внимание!**

Подлежит техническому изменению!
Для обеспечения максимальной точности результатов тестирования всегда используйте системы реагентов, поставляемые производителем прибора.

8.1 Технические характеристики - Сетевой адаптер

Тип	WR9QA2500USB52NMR6B
Конструкция	Вилка сетевого адаптера, импульсный источник питания
Входное напряжение, частота	100 – 240 V \pm 10 %, 50 / 60 Hz \pm 5 %
Входной ток	0.3 A
Первичный адаптер	Европа, Великобритания, Австралия, США
Класс защиты	II
Выходное напряжение, частота	5.2 V, DC
Макс. выходной ток	2.5 A
Защита выхода	Отключение выхода и автоматический перезапуск
Условия окружающей среды	От 0 °C до 40 °C, при макс. 95 % относительной влажности воздуха
Класс энергоэффективности	VI
Стандарт безопасности	EN 62368

Тип	WR9QA2500USB52NMR6B
EMC	EN 55032 FCC Part 15 Класс А EN 55024
Размеры [mm]	31.5 x 41 x 71 (без первичного адаптера)
Вес, с адаптером EC	48 g (без первичного адаптера лопасти)
Одобрение, EMC	CE, FCC
Допустимая высота над уровнем моря в метрах	5000 m
Уровень загрязнения	2

**Внимание!**

Подлежит техническому изменению!
Для обеспечения максимальной точности результатов тестирования всегда используйте системы реагентов, поставляемые производителем прибора.

9 Appendix

9.1 Уведомление об авторских правах и товарных знаках

Lovibond®, Tintometer® и T-CAL® являются зарегистрированными торговыми марками группы компаний Tintometer. Все переводы и транслитерации Lovibond® и Tintometer® утверждаются как торговые марки группы компаний Tintometer®. Знак Bluetooth®, фигурный знак и комбинированный знак являются товарными знаками, принадлежащими Bluetooth SIG, и любое их использование компанией Tintometer® Group осуществляется по лицензии.

RU

目录

	Page
1 简介	367
1.1 一般信息	367
1.1.1 使用前请阅读说明	367
1.1.2 产品的目的	367
1.1.3 授权使用	367
1.1.4 安全使用的要求	367
1.1.5 保存说明书	368
1.1.6 用户资格	368
1.1.7 危险化学品的处理	368
1.1.8 处置说明	368
1.2 文件中使用的符号的清单	368
1.3 缩略语	369
2 产品概况	370
2.1 认证	370
2.2 特点	371
2.3 产品描述	371
2.4 仪器视图	371
3 开始准备	372
3.1 操作环境	372
3.2 交付的内容	372
3.3 插入和更换电池	373
4 操作步骤	375
4.1 首次启动	375
4.2 一般操作原则	376
4.3 显示屏及其功能列表	377
4.3.1 显示屏	377
4.3.2 控制元素及其功能列表	378
4.3.3 状态栏	380
4.4 测量	381
4.4.1 测量界面描述	381
4.4.2 执行测量	382
4.4.3 测量提示	383
4.4.4 测量设定	384
4.5 校准	384
4.5.1 校准	384
4.5.2 执行校准	385
4.5.3 校准设置	386

	Page
4.6 核查	387
4.6.1 核查概述	387
4.6.2 执行验证	387
4.6.3 描述各个工作步骤或用户界面的各个部分	388
4.7 日志	388
4.7.1 选择一个日志类型	388
4.7.2 检索日志	389
4.8 仪器设置	390
5 维护	392
5.1 推荐采用维护计划	392
6 故障排除	393
6.1 错误信息和如何处理	393
7 配件和替换零件	394
7.1 配件列表	394
7.2 配件清单	394
8 技术参数	395
8.1 技术参数 - 主电源适配器	397
9 附录	398
9.1 版权和商标通知	398

1 简介

1.1 一般信息

1.1.1 使用前请阅读说明

本手册提供了有关本产品安全操作的重要信息。请仔细阅读本手册，并在使用前熟悉本产品。

1.1.2 产品的目的

TB 系列便携式浊度仪用于分析收集并密封于专用玻璃试样瓶中的水样的浊度。试样瓶采用了缜密的技术，以减少灰尘和划痕对测量过程的干扰。准备完毕后，将试样瓶放在仪器中进行测量。

该仪器可以在实验室使用，也可以带到现场，在收集样品时即刻测量。

请小心运输。如果将仪器带入野外，应使用手提箱。

若应用于监管，建议与当地政府联系，确保选择正确的仪器型号。

1.1.3 授权使用

如出现不正当使用、不遵守本手册、由不合格人员使用或未经授权改变产品现象，制造商不承担相关责任和损害保证。

制造商对用户或第三方因使用本产品而产生的费用或损失不承担任何责任，特别是在不正确使用产品或误用或产品连接出现故障的情况下。

制造商对打印错误不承担任何责任。

1.1.4 安全使用的要求

为安全使用本设备，请注意以下几点：

- 如果以制造商未指定的方式使用本设备，可能会损害本设备的性能。
- 本产品只能按照上面规定的授权使用方式使用。
- 本产品只能由本操作手册中提到的电源。
- 本产品只能在本操作手册中提到的环境条件下使用。
- 本产品不得被打开或修改。

出现下列情况，不得使用该产品：

- 产品有明显的损坏（例如，在运输之后）。
- 在不当条件下存放了很长时间（存放条件，见“技术参数”）。

安全使用插入式电源装置的先决条件

为安全使用，请遵守以下几点：

- 在使用前检查是否有明显的损坏。如果损坏，请不要投入使用。
- 只在干燥的房间内使用。
- 只能用干手操作。
- 只能使用制造商推荐的电源。
- 不得打开或修改该产品。
- 只能使用制造商推荐的USB-C电缆为设备供电。

ZH

1.1.5 保存说明书

手册必须放在产品的附近，以便你能随时找到你需要的信息。

1.1.6 用户资格

操作人员必须能够理解并正确执行产品包装和插页上的安全标签和安全说明。用户必须有能力和能够阅读和理解本手册，以熟悉操作并确保安全使用。

1.1.7 危险化学品的处理

使用本产品的地方可能存在化学和/或生物危险。在使用本产品时，请遵守所有管理法律、法规和协议。

对于产品的开发，Lovibond® 公司密切关注安全问题。一些危险物质的危害是无法避免的。

如果使用自制的试验或溶液，那么这些试验或溶液所造成的任何风险的责任由使用者承担（个人责任）。

为了保护您自己，使用高于 5 NTU 的浊度标准，建议戴上防护手套和护目镜。请遵守相关的安全数据表指示。

化学品安全数据表（SDS）指示包括安全处理、可能发生的危险、在危险情况下应采取的预防措施以及应采取的措施。

1.1.8 处置说明

根据当地法律规定，将电池和电气设备丢弃在合适的设施中。

将电池与生活垃圾一起处理是违法的。

在欧盟范围内，在设备的使用寿命结束后，电池要在专门的回收点进行处理。



标有此标志的仪器不得在正常的生活垃圾中处理。

1.2 文件中使用的符号的清单

本手册中使用了以下符号来表示需要特别注意的部分。



危险!

危险！若不加以避免，可能导致死亡或引起严重伤害！



警告！

对某些试剂处理不当会损害你的健康。在任何情况下，都要遵循包装上的安全标签、包装内页的安全说明和可用的安全数据表上的信息。必须严格遵守其中规定的保护措施。



注意!

存在可能导致轻度或中度伤害的危险。

ZH

1.3 缩略语

缩略语	注释
NTU	比浊法浊度单位
FNU	福尔马胂比浊法单位
mg/l	浓度单位

2 产品概况

2.1 认证

EMC 传导和辐射发射	CISPR 11 (A类限额)	CE标志
EMC 抗扰度	EN 61326-1 (工业极限)	CE标志
安全性	EN 61010-1	TÜV安全标志
FCC	FCC Class A	FCC标志

FCC A类通知

本设备符合FCC规则的第15部分。操作须符合以下两个条件。

- 本设备不得造成有害干扰。
- 本设备必须接受收到的任何干扰，包括可能导致不希望的操作的干扰。

注意：根据FCC规则第15部分的规定，本设备经过测试，符合A类数字设备的限制。这些限制旨在为设备在商业环境中运行时提供合理的保护，防止有害干扰。本设备会产生、使用并能辐射无线电频率能量，如果不按照说明书的要求安装和使用，可能会对无线电通信造成有害干扰。在住宅区操作本设备可能会造成有害干扰，在这种情况下，用户将被要求纠正干扰，费用自理。

屏蔽电缆



系统与其外围设备之间的连接必须使用屏蔽电缆，以保持符合FCC无线电频率发射限制。

**注意事
项!**

修改



对本设备所做的任何未经Tintometer批准的修改都可能使FCC授予用户的操作本设备的权力失效。

**注意事
项!**

DOC A类通知 - Avis DOC, A类

本A类数字仪器符合加拿大干扰设备条例的所有要求。

2.2 特点

实验室准确性与便携性的结合

Lovibond® TB系列消除了浊度测量中的复杂问题。这项新技术提供了最高水平的准确性、操作和监管效率。

- 触摸屏界面，便于操作
- 图片指导说明，引导用户完成流程步骤，避免错误。
- 简单的数据管理协议以确保数据的完整性

2.3 产品描述

浊度是样品光学特性的一种表现，它使光线在流体样品中被散射和吸收，而不是以直线传输。在水中，浊度通常是由粘土、淤泥、细小的有机物、浮游生物、其他微生物、有机酸和颜料等物质的存在造成的。浊度测量用于监测去除或改变溶液中颗粒浓度的过程，如饮用水的生产过程。这些Lovibond®浊度计的设计结合了实验室浊度计应有的高精度和高灵敏度以及便携性。

2.4 仪器视图

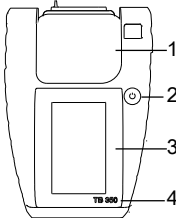
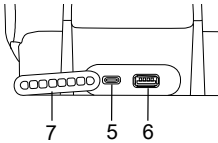
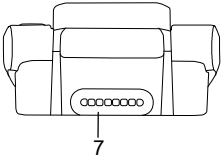
职位	描述	功能
	1. 测量槽盖	抬起时，允许用户将样品池放在仪器中进行读取。
	2. 电源按钮	打开和关闭仪器的电源。
	3. 触摸屏	显示仪器的用户界面。
	4. 型号	确定仪器版本。
	5. USB-C端口	从外部电源为仪器供电，或为电池组附件充电（如已安装）。
	6. USB-A端口	支持外部USB-A设备的功能，如数据传输或备份。
	7. 密封塞	当连接不使用时，用于覆盖USB和Type-C端口。
		

3 开始准备

3.1 操作环境

该仪器可以在任何被认为对操作者安全的室内或室外环境下进行分析

本仪器可接受0至70°C的水样

进行测量时，仪器应保持水平 $\pm 15^\circ$ 。

仪器应放置在一个水平面上，以达到最佳的测量性能。

ZH

3.2 交付的内容

仔细检查所有物品，确保以下清单中的每一个部分都在，并且在运输过程中没有发生明显的损坏。如果有任何损坏或丢失的东西，请立即联系您当地的经销商。

TB	350 IR	350 WL
浊度仪	X	X
硅油，15毫升	X	X
超细纤维布	X	X
2 个试样瓶	X	X
螺丝刀	X	X
刷子	X	X
带填充物的手提箱	X	X
快速启动指南	X	X
合格证书	X	X
保修手册	X	X
4个AA电池	X	X
可充电电池组		
USB-C电缆		
交流电源		
用于美国、英国和欧盟插头的适配器		
T-CAL [®] Standard, 5 NTU	X	X
T-CAL [®] Standard, 20 NTU	X	X
T-CAL [®] Standard, 800 NTU	X	X
T-CAL [®] Standard, 2000 NTU		X
T-CAL [®] Standard, 4000 NTU	X	X

3.3 插入和更换电池

使用电池时

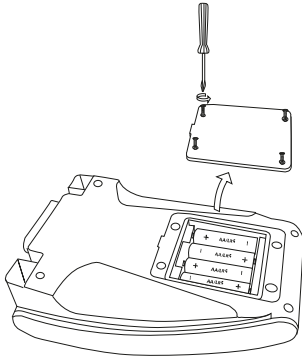

步骤	说明
1	用螺丝刀卸下仪器背面的四颗螺丝，卸下面板。
2	按照正确的方向插入四节AA电池。
3	将面板装回仪器上。



注意！

- 只能使用经批准的类型：碱性电池，LR6，电压为 1.5V。
- 尽快从设备中取出空电池。
- 如果设备长时间不使用，请从设备中取出电池。

使用可充电电池组时

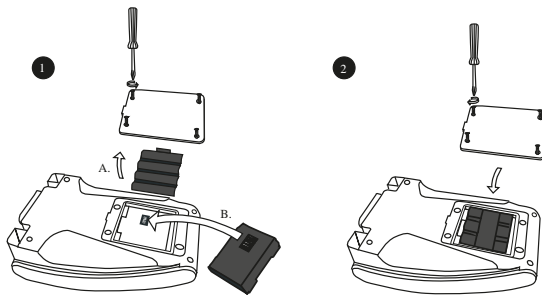

步骤	说明
1	用螺丝刀卸下仪器背面的四颗螺丝，卸下面板和电池托盘。
2	以正确的方向插入可充电电池组。
3	将面板装回仪器上。

**警告！**

可充电电池组 (19820-011) 仅适用于序列号为 23041000 及以上的仪器。
 将电池组用于序列号在 23041000 之前的仪器可能会导致设备在充电过程中过热。
 过热会导致读数不正确和设备损坏，因此必须避免。对于序列号在 23041000 之前的仪器，请与 Lovibond® 联系，了解如何使用该附件的细节。

4 操作步骤

4.1 首次启动



1. 欢迎屏幕

用户在第一次开机时看到的初始屏幕

按>按钮



2. 选择语言

选择所需的语言来设置

按>按钮



3. 设置日期和时间

选择12小时和24小时格式

使用向上和向下的箭头改变数值

按>按钮



4. 密码

设置一个用户选择的密码来实现仪器的安全功能

按保存按钮

如果不需要密码，选择“跳过”

按>按钮



5. 默认单位

选择所需的单位类型来设置

按>按钮



6. 用户信息

输入仪器所有者信息

按保存按钮

如果不需要任何细节，选择“跳过”

按>按钮



7. 信息摘要

检查初始设置

按<，在继续前改变设置

按<，进入主屏幕

用户可在仪器上选择需要的操作

4.2 一般操作原则

TB系列便携式浊度仪的设计被分解成各自的功能部件，并进行了详细的讨论。这些部件包括光源、90度散射光捕获器、散射光检测器、浊度计样品瓶以及这些关键部件如何协同工作以提供浊度结果。

TB系列便携式浊度仪的简化光学配置。

该图显示了入射光路和90°散射光检测器的视图。

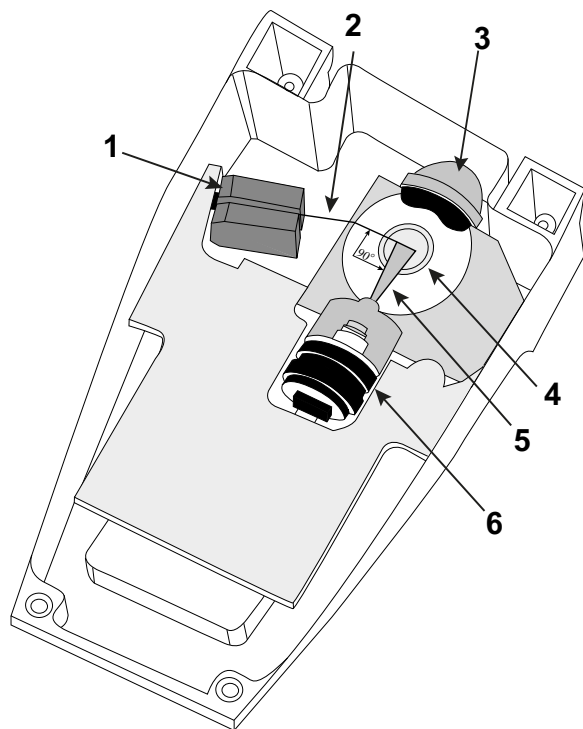

- 1 照明器 (LED和光学元件)
- 2 入射光路
- 3 90°杂散光捕获器
- 4 样品瓶
- 5 散射光 (10°-20°探测器视图)
- 6 散射光检测器和光学器件



4.3 显示屏及其功能列表

4.3.1 显示屏



描述	职能
1 状态栏	显示通用的图标和标签，包括时间、蓝牙®、USB、安全、光源和电源。
2 功能栏	显示应用步骤和互动的区域。
3 导航栏	主要用于导航，开始或保存或取消行动及返回主页。

图标	描述
	测量模式
	校准模式
	验证模式
	数据记录

图标	描述
	蓝牙连接到PTV过程浊度仪 (TB 350不提供)。
	仪器设置

ZH

4.3.2 控制元素及其功能列表

图标	描述	职能
	应用名称	用户目前正在使用的应用程序的标题。
	时间	时间由用户在初始设置中或通过访问仪器设置来设定。有12小时或24小时格式可供选择。
	USB	如果显示，表明有一个USB模块连接到设备上。
	蓝牙图标 - 普通 ²⁾	如果显示，则表示蓝牙®模块已连接。
	蓝牙图标 - 带箭头 ²⁾	如果显示，说明蓝牙®模块已连接，并正在与PTV或AquaLX应用程序进行通信。
	红色光源 - 填充	仪器包含一个红色的LED光源；测量时光被打开。
	红光源 - 概要	仪器包含一个红色LED光源；没有测量活动。
	白色光源 - 填充	仪器包含一个白色的LED光源；测量时光被打开。
	白光源 - 概要	仪器包含一个白色LED光源；没有测量活动。

图标	描述	职能
	红外线光源 - 开	仪器包含一个红外LED光源；测量时光被打开。
	红外线光源 - 关闭	仪器包含一个红外LED光源；没有测量活动。
	激光光源 - 填充 ¹⁾	仪器包含一个激光LED光源；测量时光被打开。
	激光光源 - 概要 ¹⁾	仪器包含一个激光LED光源；没有测量活动。
	交流电池充电	交流电池正在充电。
	交流电源图标	表示仪器通过AC电源供电
	电池电源 - 绿色	表示电池还有100%的寿命。
	电池电源 - 黄色	表示还有75%的电池寿命。
	电池电源 - 橙色	表示还有50%的电池寿命。
	电池电源 - 红色	表示还有25%的电池寿命。
	测量室盖打开	表明测量室盖是否打开。
	测量室盖关闭	表示测量室的盖子是否关闭。



¹⁾ 只有 TB 600

2) 不 TB 350

4.3.3 状态栏

图标	图标	职能
	主页按钮	让用户返回主屏幕。
	主页按钮 - 已锁定	安全性已被激活；密码已被启用，需要执行某些功能。
	主页按钮 - 已解锁	安全是不活跃的；没有任何功能被阻止给用户。
	保存按钮	保存显示在活动区域的内容。
	设置按钮	打开一个应用程序的设置菜单
	出口按钮	导出显示在活动区域的日志。
	测量按钮	开始或开始或启动一个测量。
	测量按钮 - 带有蓝牙 ^{®2)}	在连接到PTV装置时进行测量。
	蓝牙 [®] 刷新按钮 ²⁾	刷新仪器附近的可用PTV单元列表。

ZH

图标	图标	职能
	取消按钮	提供取消当前活动区域的活动的选项。
	右边的雪佛龙	在一个过程中推进到下一个步骤。
	左边的雪佛龙	返回到一个过程中的前一个步骤。

²⁾ 不 TB350

4.4 测量

4.4.1 测量界面描述

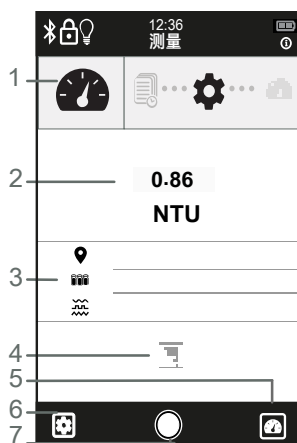

描写	职能
1 应用程序栏	导航路径，帮助用户完成流程步骤。
2 测量结果	显示带单位的测量结果。
3 设置	显示应用于测量的设置。
4 日志按钮	当按下时创建一个日志。
5 测量按钮	按下后开始测量。
6 设置钮	用来改变设置。
7 主页按钮	使用户返回主屏幕。

4.4.2 执行测量

在测量之前，请准备好交付范围内的试样瓶。请确保试样瓶没有污点、划痕或瑕疵。

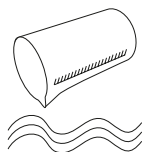
**1. 收集样品**

确保样品具有代表性（充分混合）。
玻璃器皿应无污点、划痕或其他瑕疵。
在收集样品前，用样品至少冲洗收集容器两次。

**2. 准备好试样瓶**

使用无绒布，擦干试样瓶的外部。
使用硅油以减少杂散光的反射。

**3. 将试样瓶插入仪器**

插入前，确保样品无气泡。
在插入前慢慢倒置混合，不要摇晃。

**4. 关闭盖子**

合盖前禁止测试。

**5. 检查设置**

确保测量设置是正确的。测量发生后不能改变测量的设置。

**6. 按下测量按钮**

开始测量。

**7. 数据记录**

进入数据日志，保存测量结果。

**8. 保存测量结果**

如果需要，请按 "保存" 按钮，以创建一个测量日志。

**9. 暂停**

在 "连续" 测量模式下暂停测量。



- 除了用于测量的试样瓶，不要将任何物体放入测量室。
- 请避免任何液体进入测量室。

警告!

4.4.3 测量提示

对小瓶进行分度：最好用装满通过0.2微米过滤器过滤的水的小瓶来进行。

- 按下测量按钮。
- 转动样品。在旋转小瓶的同时，确定最低的读数。
- 确定位置后，停止测量。在小瓶上做标记。
- 在继续进行其他测量之前，如有必要，确保测量模式得到更新。
- 如果玻璃器皿上有明显的划痕或凹坑，建议对样品瓶进行索引。

硅油的使用

- 请注意只用顶部的三分之一来处理小瓶。
- 用提供的清洁布擦拭小瓶，去除水、灰尘和指纹。
- 用硅油涂抹小瓶的外部。
 - 在小瓶的侧面涂上很薄的硅油珠子。将油珠均匀地涂在小瓶底部的2/3处。
 - 通过旋转小瓶，用一块干净的无尘布擦拭小瓶中的硅油。
- 在测量预期浊度低于0.5NTU的样品时，给细胞上油是很关键的，建议使用。

含有多余气泡的样品

- 让样品静置至少5分钟。
- 轻轻地将样品倒置两到三次以重新悬浮浊液。
- 放在仪器中，按指示进行。

其他注意事项

- 不建议使用超声波浴。超声波能量会改变颗粒分布。
- 对于具有高浓度沙子或高密度颗粒的样品，使用快速设置模式。

4.4.4 测量设定



按下设置按钮，进入测量设置模式。

图标	描写	选项	职能
	模式	单次测量	按下触发一个测试。
		连续 ¹⁾	测量每X秒更新一次，直到停止。
		快速沉淀测量	建议用于具有快速沉降特性的样品。
	位置	默认	如果没有设置自定义ID，则使用。
		自定义	用户定义的测量位置描述 和测量极限。
	信号平均	开启了	如果开启，可设置为255个测量值。 如果测量不稳定，应利用该功能。
		关	已停用
	样品液ID	默认	如果没有设置自定义ID，则使用。
		自定义	样品的唯一标识符；用户可选择。

¹⁾ 不 TB350

4.5 校准

4.5.1 校准

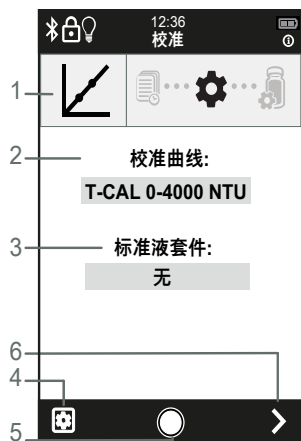

描述	功能
1 应用程序栏	导航路径，帮助用户完成流程步骤。
2 校准曲线	指定校准类型。
3 标准液套件	标准液套装特定标识
4 设置按钮	用来改变设置。
5 主页按钮	使用户返回主屏幕。
6 下一个按钮	进展到下一个屏幕。

4.5.2 执行校准

在校准之前，请准备好交货范围内的 T-CAL® 标准液。确保 T-CAL® 试样瓶没有污点、划痕或瑕疵。

- 用于 TB 350 IR 的 T-CAL® 标准液：20 / 800 / 4000 NTU
- 用于 TB 350 WL 的 T-CAL® 标准液：20 / 800 / 2000 / 4000 NTU



- 1. 零点调整。**
进行零点调整。

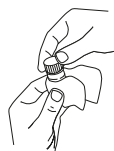

- 2. 准备好标准液试样瓶**
必要时给标准液试样瓶涂硅油



- 3. 插入标准液试样瓶**
插入屏幕上指定标准值标准液试样瓶。
用户将插入一系列不同的浊度标准的标准液试样瓶来完成校准。



- 4. 状态**
代表活动进行中



- 5. 日志摘要。**
按 "保存" 按钮，保存日志。
按 "取消" 按钮，返回到校准过程的开始。

4.5.3 校准设置



按下设置按钮，进入测量设置模式。

图标	描写	选项	职能
	校准曲线	T-CAL®	选择预设浓度的稳定的福尔马兹标准品
		用户	选择用户准备的预定浓度的福尔马林标准品 Formazin
	标准液套件	默认	如果没有设置唯一标识符，则使用。
		独特的	标准集的唯一标识符。
	提示 ¹⁾	开启了	提醒用户校准到期。 可选择在其他测量发生前强制校准。
		关	默认设置。
	默认校准		可选择恢复到出厂校准设置。
	校准后验证	开启了	要求用户在校准完成后进行验证
		关	默认设置。
	检查校准	开启了 (默认)	在校准过程中，如果个别标准件超出公差，用户必须纠正标准件才能继续或取消校准过程。该功能可以防止用户因标准不正确而出现校准错误。日志屏幕上会有一个 "校准检查器" 的行项，它将显示 "开" 或 "启用" 状态。
		关	在校准过程中，如果个别标准超出公差，用户不会被通知校准器超出了Tintometer的预定范围。日志屏幕上会有一个 "校准检查器" 的行项目，它将显示 "关闭" 或 "禁用" 状态。

¹⁾不 TB350

4.6 核查

4.6.1 核查概述

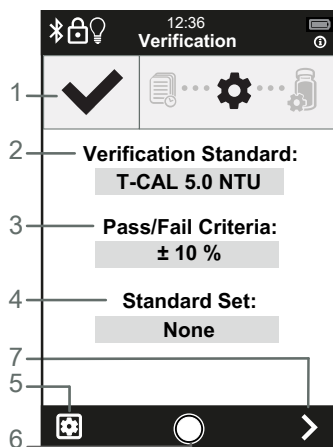

描写	职能
1 应用程序栏	导航路径，帮助用户完成流程步骤。
2 核查标准	要测量的标准值。
3 通过/失败标准	用于确定验证通过或失败的公差。
4 标准液套件	标准集的唯一标识符。
5 设置钮	用来改变设置。
6 主页按钮	使用户返回主屏幕。
7 下一个按钮	进展到下一个屏幕。

4.6.2 执行验证

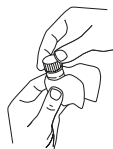

1.准备好小瓶。
必要时给样品瓶上油



3.插入标准。
插入屏幕上指定的标准值。



4.模态。
代表活动过程。



5.日志摘要。
按 "保存 "按钮, 保存日志。
按 "取消 "按钮, 回到验证过程的起点。

ZH

4.6.3 描述各个工作步骤或用户界面的各个部分



按下设置按钮, 进入测量设置模式。

图标	描写	选项	职能
	标准	T-CAL 5.0 NTU	选择5.0NTU浓度的准备好的稳定的formazin标准
		用户准备	在1到1000NTU之间选择用户准备的标准。
	Pass/Fail 标准	±10%	用于确定验证通过或失败的公差。
		± 5%	
		±0.05 NTU	
		±0.10 NTU	
	自定义		用户输入值。允许误差为±20%或±0.05 - 0.2 NTU。
	提示 ¹⁾	开启了	提醒用户核查到期。
		关掉了	默认设置。

¹⁾ 不 TB350

4.7 日志

4.7.1 选择一个日志类型



按行动区的日志类型按钮来访问日志。

应用栏



测量日志。
显示所有的测量记录。



校准记录。
显示所有校准记录。



验证日志。
显示所有验证记录



GLP模式日志。
显示GLP模式被启用或禁用的记录。

¹⁾ 不是TB350

4.7.2 检索日志



1. 选择日志类型
显示用户想查看的日志类型的记录。



2. 导出单个日志
如果选择了一条记录，该日志将以CSV格式导出。
所有与日志相关的细节都会被导出



3. 选择转移方法
USB：将协议导出到USB存储器。







蓝牙^{①)}。) 将日志导出到AquaLX移动应用程序。
在TB 350上不可用。
注意：需要一个外部Lovibond®蓝牙®加密狗来连接到USB-A端口。







¹⁾ 不是TB350

4.8 仪器设置



按下设置按钮，进入设置模式。

图标	说明	选项	功能
	安全	启用	设置、验证和更改密码。
		禁用	默认设置。
	电源设置	屏幕亮度	调整屏幕的亮度。
		背景光休眠	关
			20秒
			30秒
系统关闭	1分钟*		
	5分钟		
	关		
	1分钟		
	2分钟		
	蓝牙 ¹⁾	启用	在有硬件的情况下，启用蓝牙®。
		禁用	默认设置。
	USB捷径 ¹⁾	启用	如果启用，当USB存储设备被连接时，用户会看到一个模式，该模式提供一个"传输日志"或"备份/恢复"设置的选项。通过选择一个选项，用户被引导到相应的功能。
		禁用	默认设置；用户必须在连接USB存储设备时访问"日志"或"备份/恢复"设置。
	语言		选择语言

	日期/时间		选择显示的时间和格式。
	备份/还原	备份所有设置 ¹⁾	可以选择将设置存储到本地SD卡或保存到外部USB驱动器。
		恢复所有设置 ¹⁾	恢复以前保存在本地SD卡或外部USB驱动器上的设置。
		还原出厂设置	将所有设置重置为出厂默认值。 保存的日志仍然可用。
	单位类型	NTU	选择显示的单位。
		FNU	定义显示的测量值的单位类型。
		mg/L Kaolin	默认设置为NTU。
		mg/L PSL	
		度	
		mNTU ¹⁾	
		mFNU ¹⁾	
	自定义 ¹⁾	允许用户定义单位类型，并能够根据NTU/FNU值设置一个系数。	
	GLP ¹⁾	启用	为遵循良好实验室规范的实验室制定了数据完整性协议。
		禁用	默认设置。
	拥有者		仪器所有者的详细联系方式。
	联系我们		Lovibond®办事处的联系信息。
	关于		关于Lovibond®。

¹⁾ 不是TB350

* 默认设置

5 维护

5.1 推荐采用维护计划

任务	做	不做
1. 清洁测量室 2. 清洁仪表显示屏	1. 在测量之前，确保测量室的清洁和干燥。使用干的微纤维布来清除杂质。 2. 用干燥或微湿的微纤维布擦拭触摸屏。	1. 将任何液体直接喷入或倒入测量室。 2. 测量一个没有被紧紧盖住的试样瓶。
清洁外壳	用温和的洗涤剂溶液或稀释的酒精清洁外壳。	
试剂瓶的储存与护理	使用后一定要用不含浊度的水冲洗试样瓶。	未擦掉试样瓶上过量的硅油。一滴硅油就足够。
	用去离子水填充试试样瓶。盖上小瓶以防止形成水斑。	试样瓶不加盖子，以便风干。
	用超细纤维布将试样瓶外侧擦干。	使用任何有明显缺陷的试样瓶，包括坑洞、划痕或裂缝
更换电池	如果仪器存放超过30天，建议取出电池，以防止电池泄漏。	使用未指定类型的电池。
校准	在以下条件下，根据需要进行校准。 1. 验证失败。 2. 对光学或电子系统进行了维护。 3. 按照当地监管部门的要求。	使用过期标准液
	仔细按照说明准备和使用标准液	
验证	在以下条件下验证仪器性能。 1. 进行校准后。 2. 根据内部质量控制程序。 3. 按照地区监管部门的要求。	使用过期标准液
	仔细按照说明准备和使用标准液	
连接器/密封塞	步骤实验环境中时，确保连接器塞好密封塞。	在没有连接密封塞的情况下存放设备。
		插着连接器运输设备或用连接器支撑设备。



警告！

对某些试剂处理不当会损害你的健康。在任何情况下，都要遵循包装上的安全标签、包装内页的安全说明和可用的安全数据表上的信息。必须严格遵守其中规定的保护措施。

6 故障排除

6.1 错误信息和如何处理

错误信息	可能的原因	解决方案
超出范围	样品的浊度超出仪器的测量范围。	<ul style="list-style-type: none"> • 稀释样品 • 使用高量程标准液校准。
低范围	样品的浊度低于仪器的检测极限。	<ul style="list-style-type: none"> • 按规定重复杂散光测量（零点调整），并确保测量室盖子关闭。 • 在确定杂散光后重复校准。
浊度仪不开机	电池有缺陷 电池没有正确插入	<ul style="list-style-type: none"> • 更换一套新的碱性电池
"保存"按钮没有出现，所以不能创建日志。	缺少必要的信息。	确保填写用户信息和所有必填字段。
仪器无法进行测量	盖子没有关闭。	关上盖子。
低电量提醒	电池电量低于 20%	更换或充电电池。
用户无法更改设置	设备安全协议已激活。	输入密码以解锁设置和校准功能。
校准误差	试样瓶不清洁	<ul style="list-style-type: none"> • 使用手册中的程序重新清洗试样瓶。按照手册中的规定储存试样瓶。 • 检查标准液的到期日
校准误差	插入标准液顺序错误。	用标准液从浊度最低到最高顺序重复校准。
校准误差	标准液没充分混合。	校准步骤前，按指示混合标准液。
校准误差	标准液浊度值错误。	重新制备标准液，确保正确稀释。
验证误差	验证误差超过接受范围。	<ul style="list-style-type: none"> • 充分混合验证标准液。 • 检查验证标准液，确保制备过程准确无误。 • 检查验证标准液的到期日。

7 配件和替换零件

7.1 配件列表

标题	货号	
Rechargeable battery pack, Ni-MH	TB350 IR, TB350 WL	19820-011
T-CAL® 标准, 4000 NTU, 125 ml	TB350 IR, TB350 WL	48012912
T-CAL® 标准, 4000 NTU, 500 ml	TB350 IR, TB350 WL	48012950
USB-C电缆1米, USB-C到A	TB350 IR, TB350 WL	19820-081
刷子, 长 11 cm	TB350 IR, TB350 WL	380230
带黑色盖子的试样瓶, 高 55 mm, 直径 24 mm, 12 件套	TB350 IR, TB350 WL	197655
浊度标准 T-CAL 套件 (5, 20, 800, 2000, 4000 NTU)	TB350 WL	194152
浊度标准 T-CAL 套件 (5, 20, 800, 4000 NTU)	TB350 IR	194154
清洁布	TB350 IR, TB350 WL	197635
电池 (AA), 4 件套	TB350 IR, TB350 WL	1950025
电源 TB series	TB350 IR, TB350 WL	19820-170
硅油	TB350 IR, TB350 WL	194295
试样瓶支架, 用于 6 个Ø 24 mm 圆形试样瓶	TB350 IR, TB350 WL	418951

7.2 配件清单

描述	零件编号
携带箱	19820-130
盖子, 测量室	19820-095
盖子, 电池仓	19820-098
密封塞, 弹性, IP67, I/O	19820-084
4节AA电池的插件	19820-012

8 技术参数

Model	Model WM-040-1004 (IR) Model WM-040-1001 (WL)
光源	红外线LED (860 nm) 白光LED
标准	ISO 7027 美国环保署批准 (替代美国环保署180.1) 。
测量原理	比浊法 (Multipath 90° BLAC)
测量范围	0.01 - 4000 NTU (FNU)
解析度	0.01-9.99: 0.01 NTU ; 10.0-99.9: 0.1 NTU ; 100-4000: 1 NTU
精度	读数的 $\pm 1.8\%$ +杂散光
重复性	< 1 %或 ± 0.01 NTU
杂散光	< 0.014 NTU
显示的单位	NTU、FNU、度数、mg/L Kaolin、mg/L PSL
响应时间	7秒
阅读模式	单次测试、信号平均、Fast-Settling
校准选项	0 - 4000 NTU 的全范围校准
检光器	硅光电二极管
比率模式	是
所需的样品量	10 mL (0.4 oz)
显示	全彩色触摸屏
显示尺寸	55 x 95 mm (宽x高)
数据接口	<ul style="list-style-type: none"> • USB-A • USB-C
数据存储	250次测量、所有校准、验证和工厂修复
导出数据格式	.csv
省电模式	是
Auto – OFF	可选择
电源	<ul style="list-style-type: none"> • 3 NiMH-battery pack (AA) • 4 batteries (AA) • Universal (90 - 240 VAC), via external power supply
环境条件	温度 : 0 - 50 °C (32 - 122 °F) 湿度 : 30 °C , 0- 90 % , 无冷凝 湿度 : 40 °C , 0 - 80 % , 无冷凝 湿度 : 60 °C , 0-70 % , 无冷凝

保护等级	IP67 (仪器)
一致性	-
	<ul style="list-style-type: none"> • CE • CSA • FCC A • RoHS • TÜV • UL • WEE
多语言操作界面	<ul style="list-style-type: none"> • 中文 • 土耳其语 • 德文 • 日语 • 法文 • 波兰 • 英文 • 荷兰语 • 葡萄牙 • 西班牙
多语言快速操作指南	<ul style="list-style-type: none"> • 中文 • 俄语 • 土耳其语 • 德文 • 意大利 • 法文 • 英文 • 荷兰语 • 葡萄牙 • 西班牙
多语言用户操作手册	<ul style="list-style-type: none"> • 中文 • 俄语 • 土耳其语 • 德文 • 意大利 • 法文 • 英文 • 荷兰语 • 葡萄牙 • 西班牙

尺寸	155 x 83 x 225 mm
重量	804 g (898 g with four AA alkaline batteries)
带包装的重量	(898 g with four AA alkaline batteries)



注意!

可进行技术修改!
为确保测试结果的最大准确性, 请始终使用仪器制造商提供的试剂系统。

ZH

8.1 技术参数 - 主电源适配器

类型	WR9QA2500USB52NMR6B
设计	主电源适配器插头, 开关电源
输入电压, 频率	100 – 240 V \pm 10 %, 50 / 60 Hz \pm 5 %
输入电流	0.3 A
主适配器	欧洲、英国、澳大利亚、美国
保护等级	II
输出电压、频率	5.2 V, DC
最大输出电流	2.5 A
输出保护	输出关闭和自动重启
环境条件	0 °C至40 °C, 最大 95%的相对空气湿度
能源效率等级	VI
安全标准	EN 62368
EMC	EN 55032 FCC Part 15 等级 A EN 55024
尺寸 [mm]	31.5 x 41 x 71 (不含主适配器)
重量, 含欧盟适配器	48 g (不含垫片)
认证, EMC	CE, FCC
允许的海拔高度 米	5000 m
污染程度	2



注意!

可进行技术修改!
为确保测试结果的最大准确性, 请始终使用仪器制造商提供的试剂系统。

9 附录

9.1 版权和商标通知

罗维朋®、罗威邦®、Lovibond®、Tintometer® 和 T-CAL® 是 Tintometer 公司集团的注册商标。Lovibond® 和 Tintometer® 的所有翻译和音译都被主张为 Tintometer® 集团的商标。Bluetooth® 标记、数字标记和组合标记是 Bluetooth SIG 拥有的商标，Tintometer® 集团的任何使用都是经过许可的。

Tintometer GmbH

Lovibond® Water Testing
Schleefstraße 8-12
44287 Dortmund
Tel.: +49 (0)231/94510-0
sales@lovibond.com
www.lovibond.com
Germany

Tintometer South East Asia

Unit B-3-12, BBT One Boulevard,
Lebuh Nilam 2, Bandar Bukit Tinggi,
Klang, 41200, Selangor D.E
Tel.: +60 (0)3 3325 2285/6
Fax: +60 (0)3 3325 2287
lovibond.asia@tintometer.com
www.lovibond.com
Malaysia

Tintometer India Pvt. Ltd.

Door No: 7-2-C-14, 2nd, 3rd & 4th Floor
Sanathnagar Industrial Estate,
Hyderabad, 500018
Telangana
Tel: +91 (0) 40 23883300
Toll Free: 1 800 599 3891/ 3892
indiaoffice@lovibond.in
www.lovibondwater.in
India

The Tintometer Limited

Lovibond House
Sun Rise Way
Amesbury, SP4 7GR
Tel.: +44 (0)1980 664800
Fax: +44 (0)1980 625412
sales@lovibond.uk
www.lovibond.com
UK

Tintometer Brazil

Caixa Postal: 271
CEP: 13201-970
Jundiaí – SP
Tel.: +55 (11) 3230-6410
sales@lovibond.us
www.lovibond.com.br
Brazil

Tintometer Spain

Postbox: 24047
08080 Barcelona
Tel.: +34 661 606 770
sales@tintometer.es
www.lovibond.com
Spain

Tintometer China

9F, SOHO II C.
No.9 Guanghualu,
Chaoyang District,
Beijing, 100020
Customer Care China Tel.: 4009021628
Tel.: +86 10 85251111 Ext. 330
Fax: +86 10 85251001
chinaoffice@tintometer.com
www.lovibond.com
China

Tintometer Inc.

6456 Parkland Drive
Sarasota, FL 34243
Tel: 941.756.6410
Fax: 941.727.9654
sales@lovibond.us
www.lovibond.us
USA

Tintometer France

BAL n°227
76-78 rue Chanzy
51100 Reims
sales@lovibond.com
www.lovibond.com
France

Technical changes without notice

Printed in Germany 01/24

No.: 19820-039

Lovibond® and Tintometer® are

Trademarks of the Tintometer Group
of Companies

